

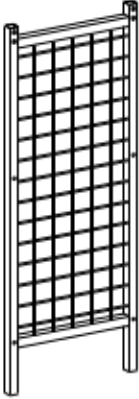





<p>J  × 1</p>	<p>K  × 4</p>	<p>3  20+2</p>
<p>7  24+2</p>	<p>8  24+2 M6 × 12 mm</p>	<p>26  × 1</p>
<p>27  × 1</p>	<p>29  × 4</p>	
<p>31  × 2</p>	<p>39  × 1</p>	

Tools Required:

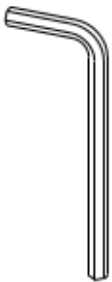

1

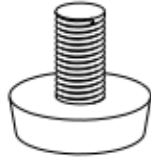
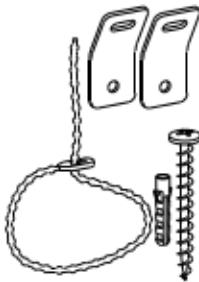
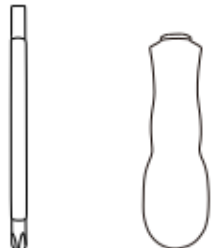
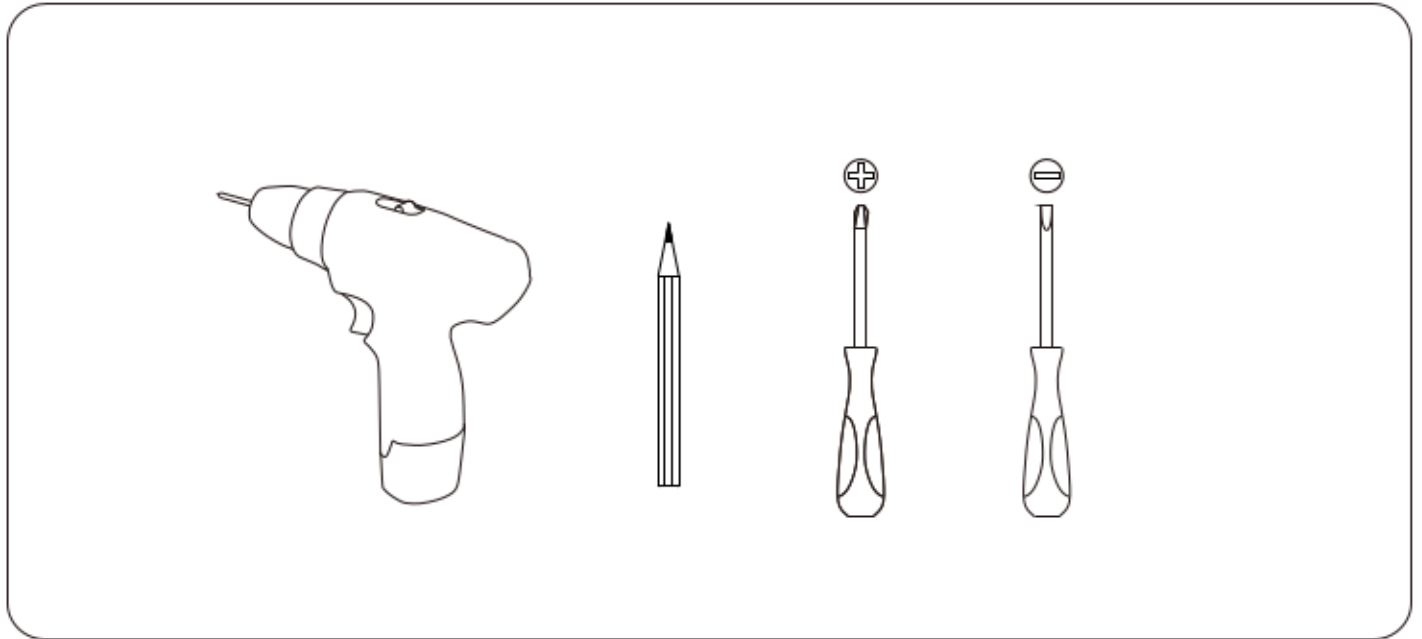
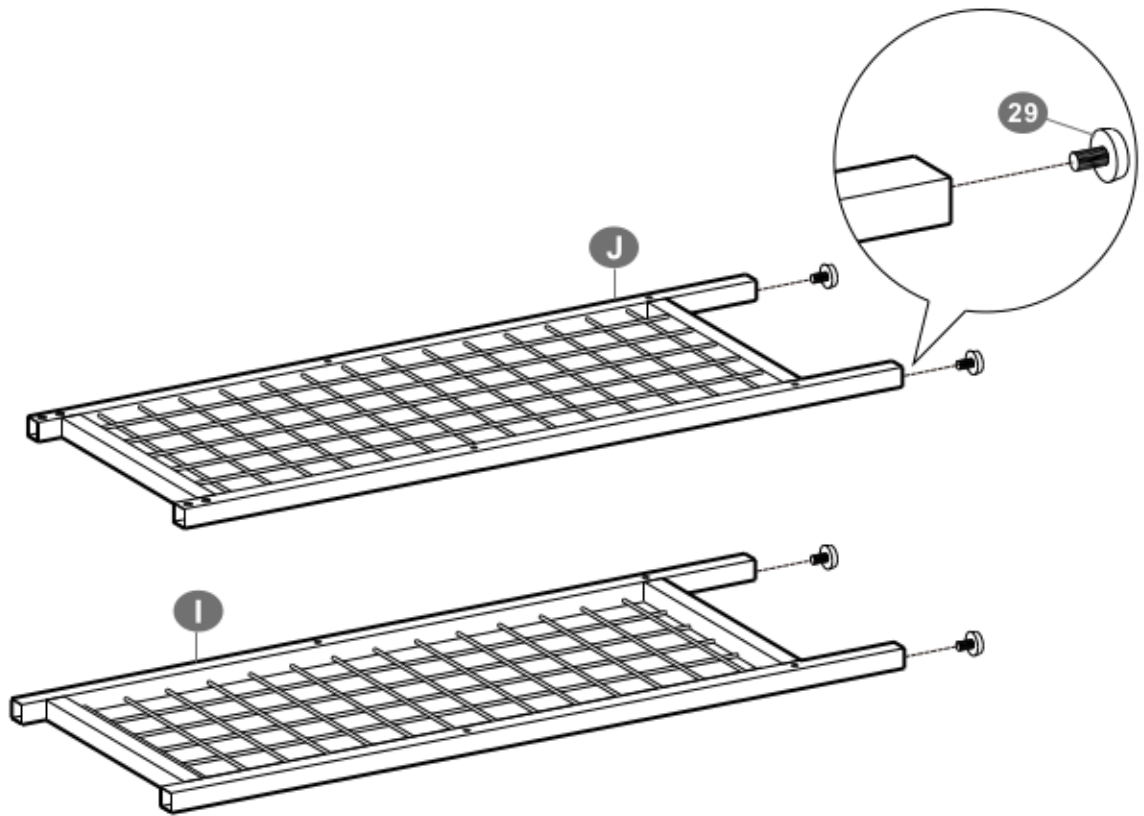

29



4PCS

2

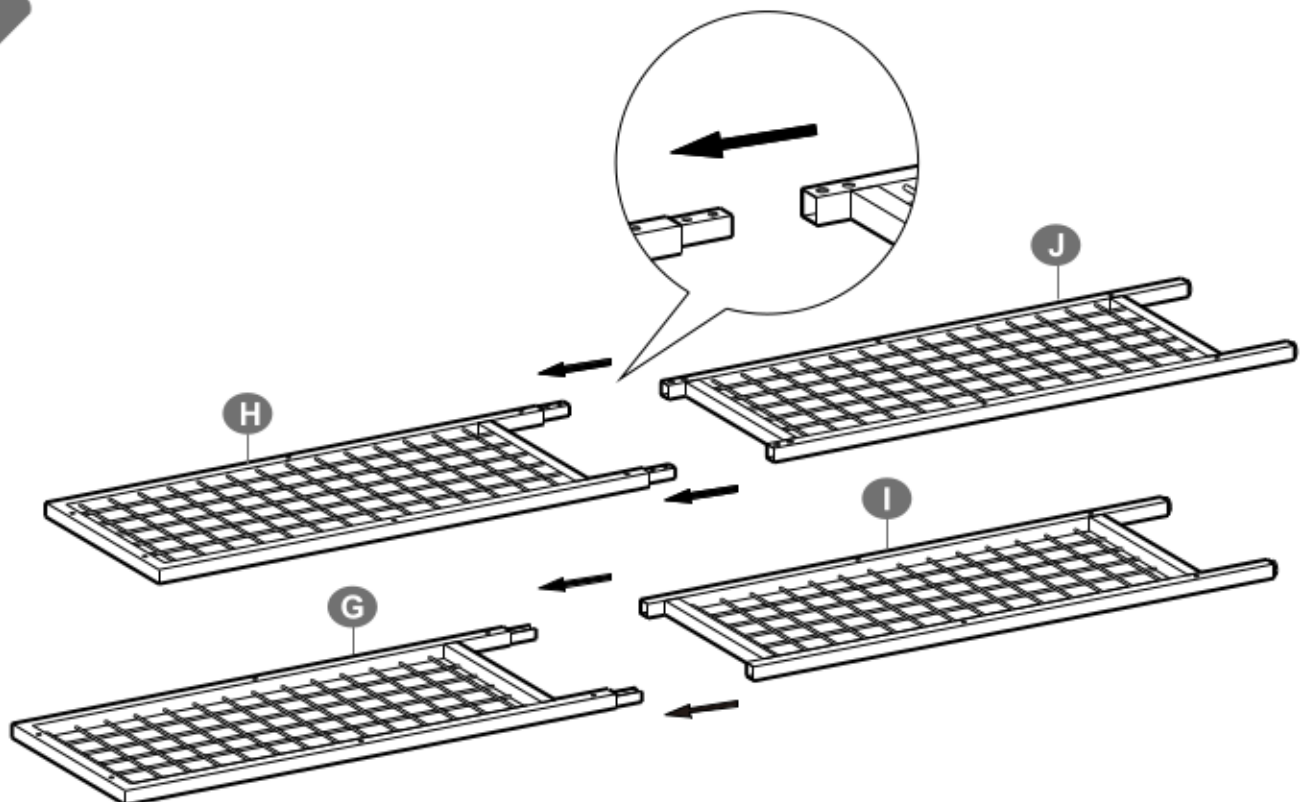

3

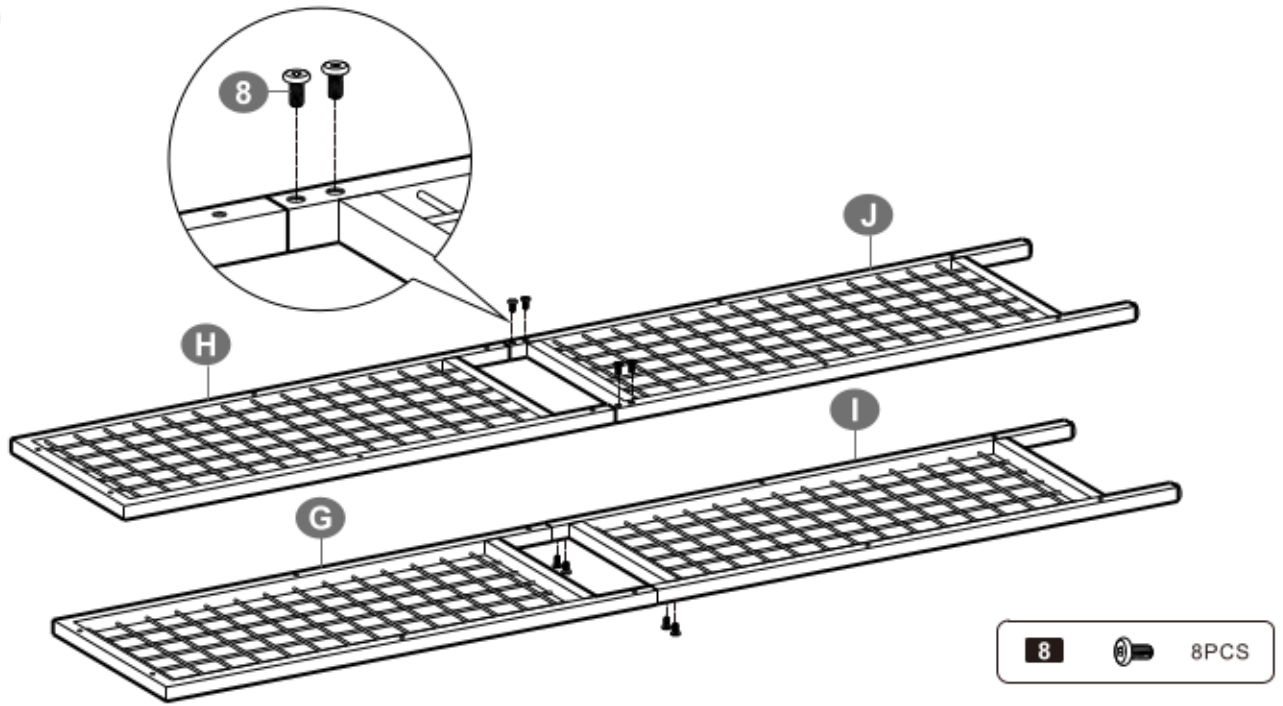

4

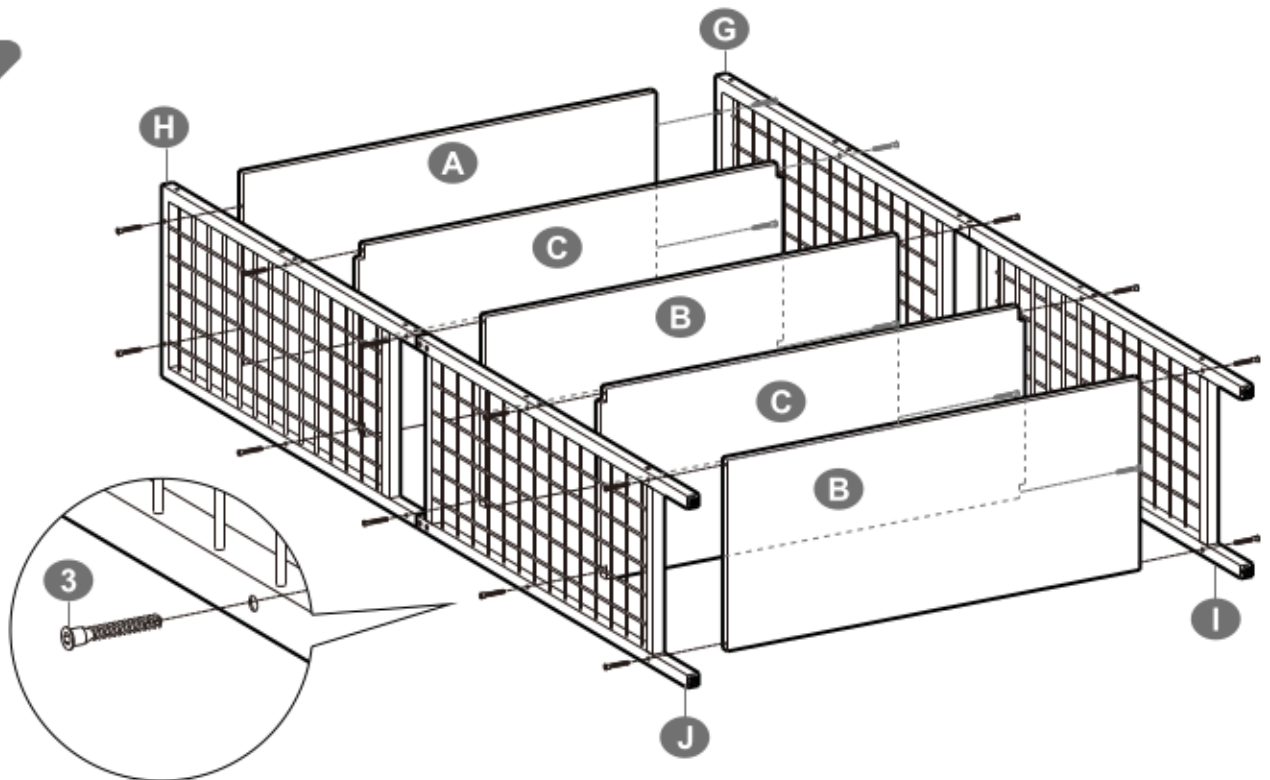



3 20PCS

5

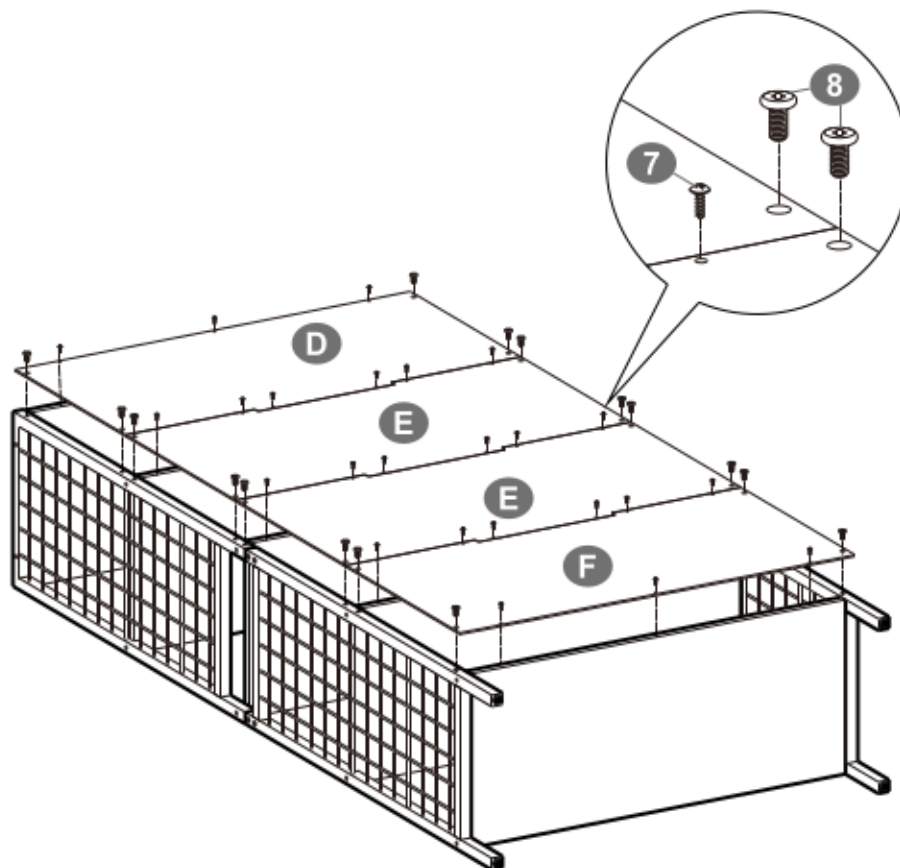
- EN** • Apart from the back board, the other wooden boards don't come with screw holes. The installation of the back board requires 2 people to insert the screws from the holes of back board into the frame of other boards with screwdriver directly.
- DE** • Bitte beachten Sie, dass nur die Rückwandplatte mit Schraubenlöchern versehen ist, die Rückseite der anderen Holzplatten nicht. Drehen Sie die Schrauben mithilfe eines Schraubendrehers durch die Öffnungen der Rückwandplatte direkt in die anderen Holzplatten hinein. Dieser Montageschritt sollte von zwei Erwachsenen durchgeführt werden.



7		24PCS
8		16PCS

6

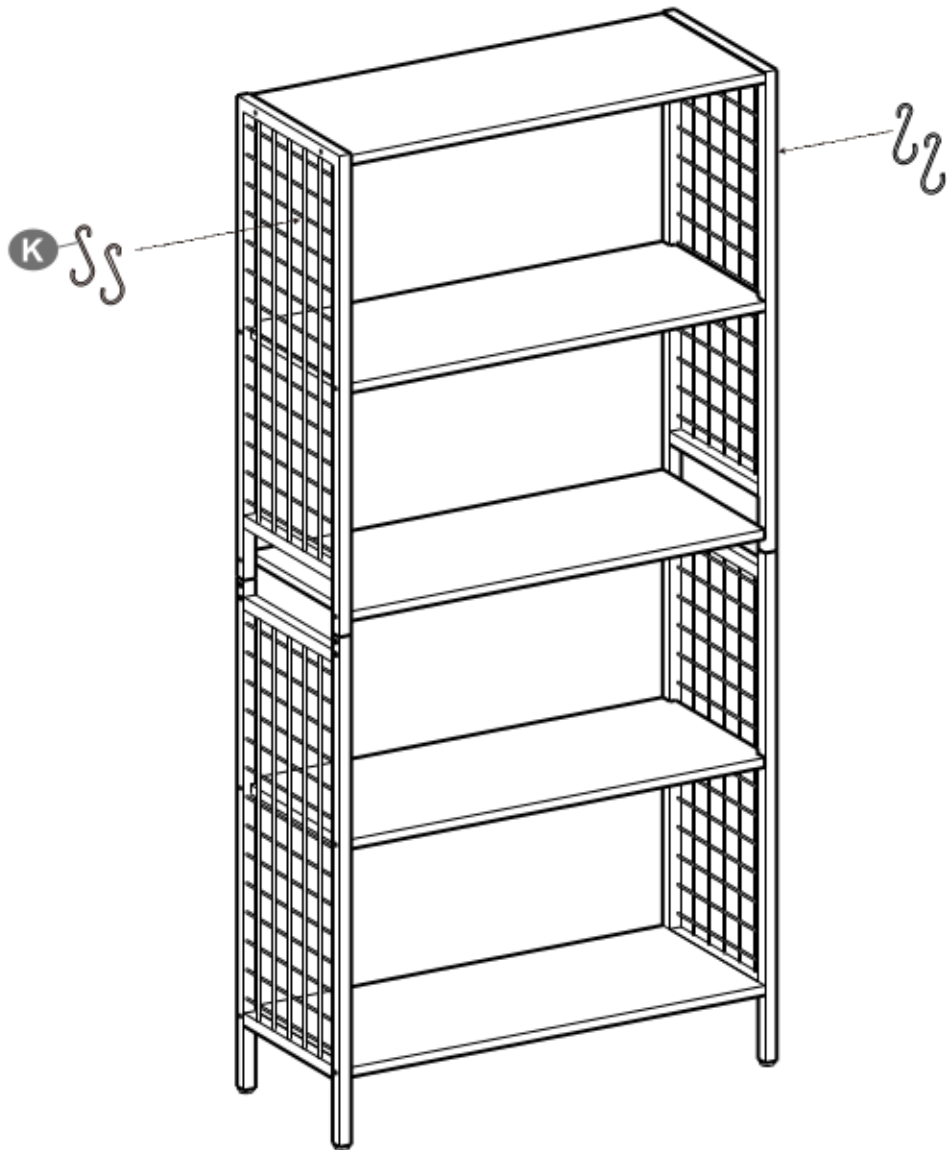

7

