

M4x10
Ax4



M6x8
Bx1



Ø30
Cx4



4MM
Dx1



1

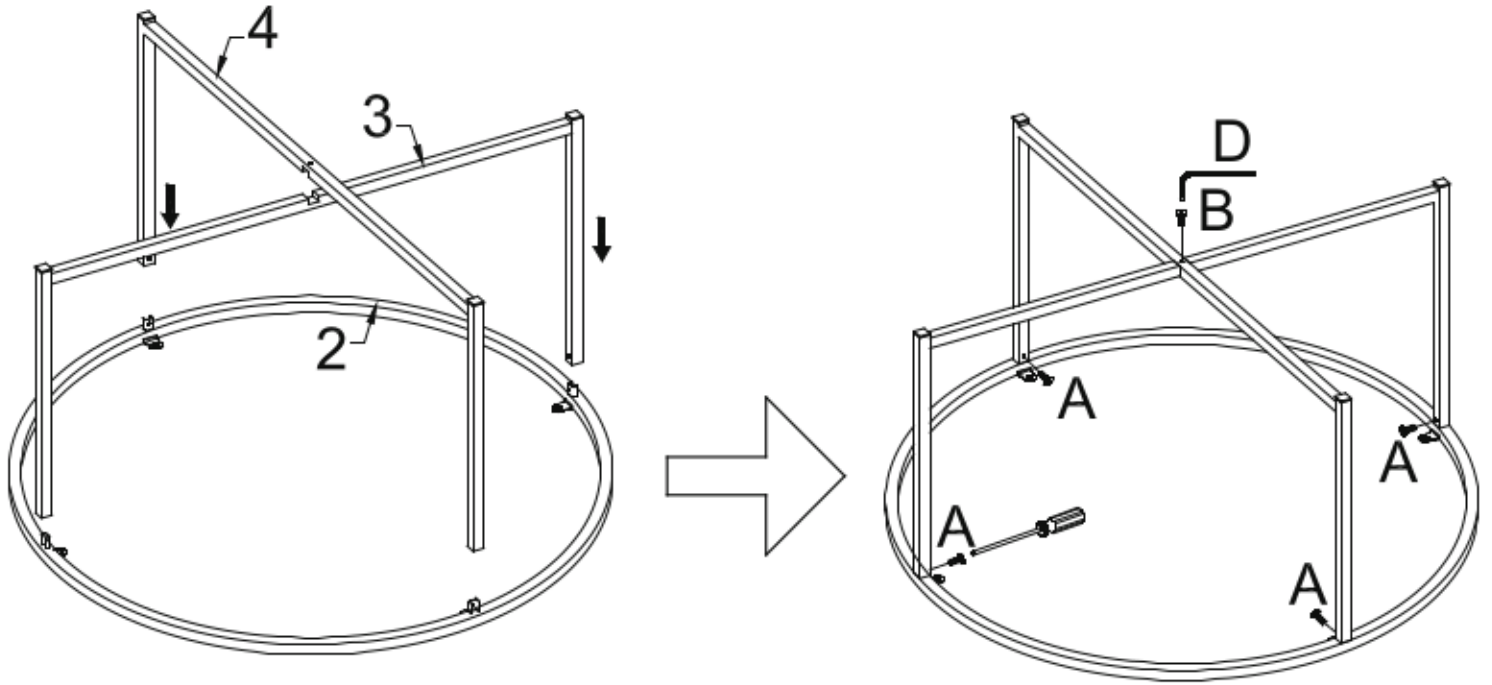

2

