

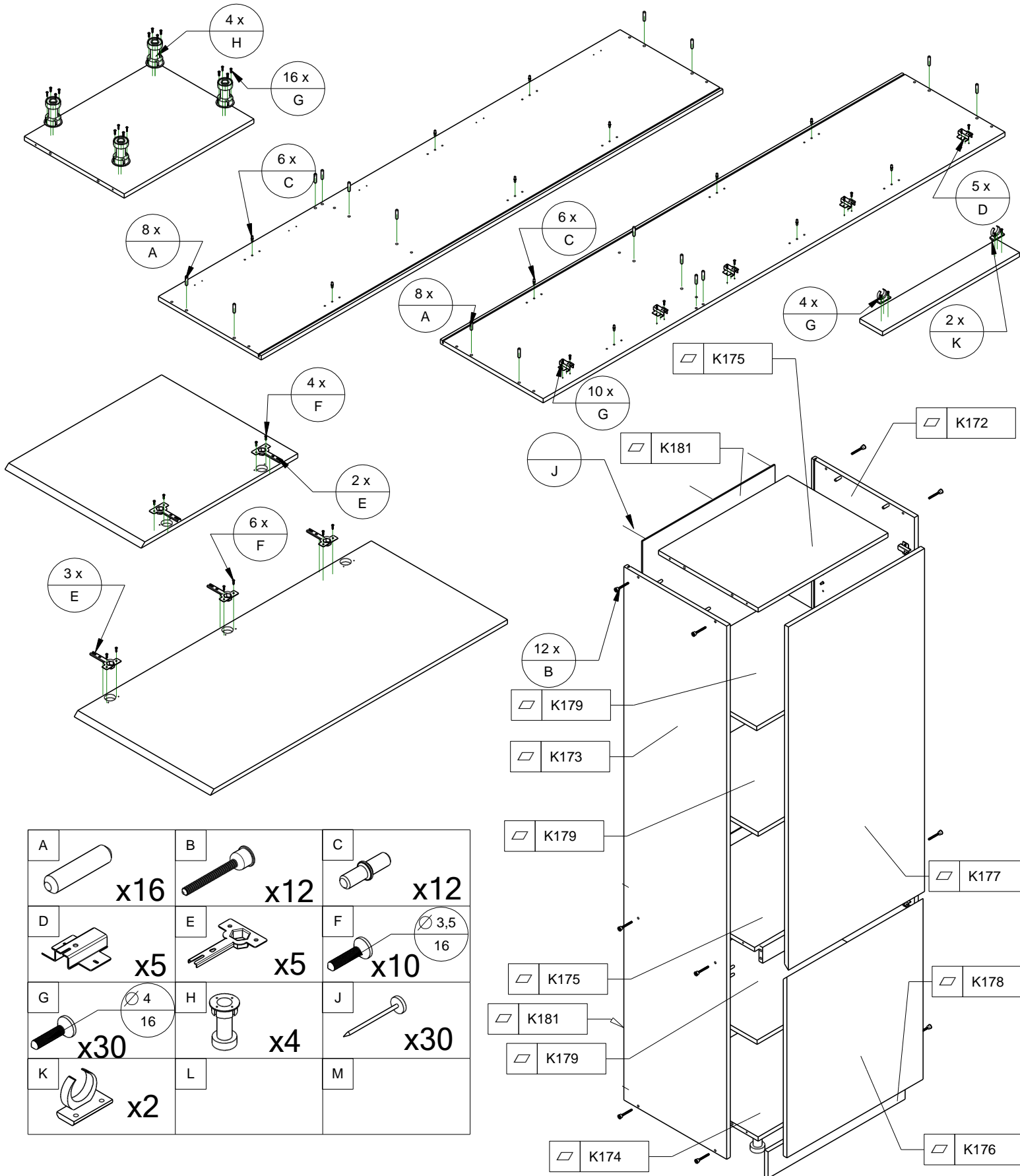







D60 SŁUPEK

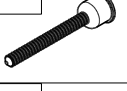

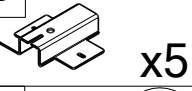
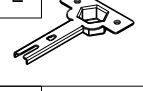
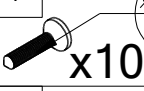
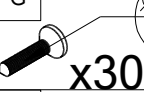
A	 x16	B	 x12	C	 x12
D	 x5	E	 x5	F	 x10 $\varnothing 3,5$ 16
G	 x30 $\varnothing 4$ 16	H	 x4	J	 x30
K	 x2	L		M	

