

D-30-197/ DC-30-197

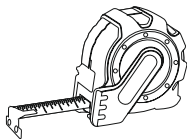

ø5

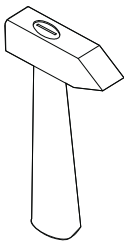
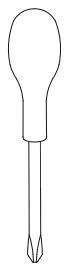
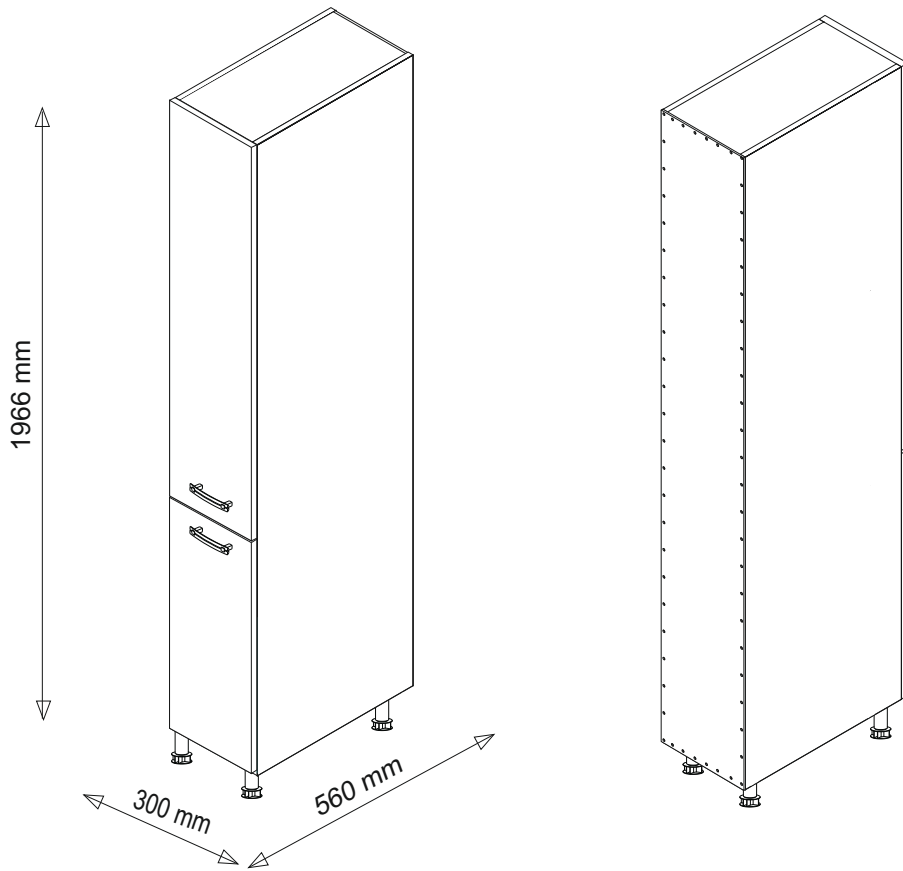
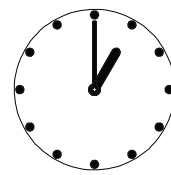
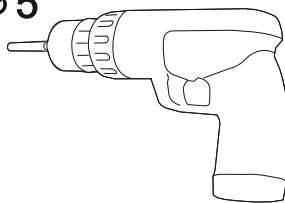

30 min

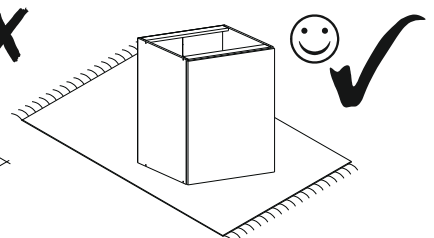
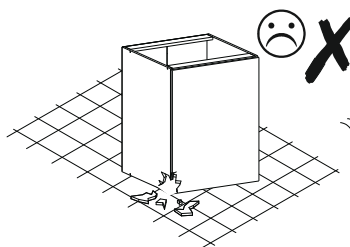
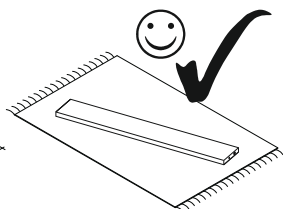
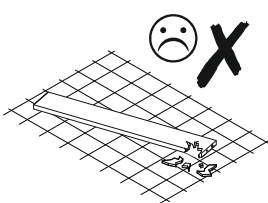
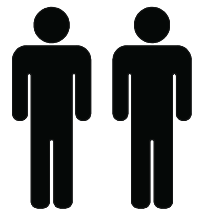

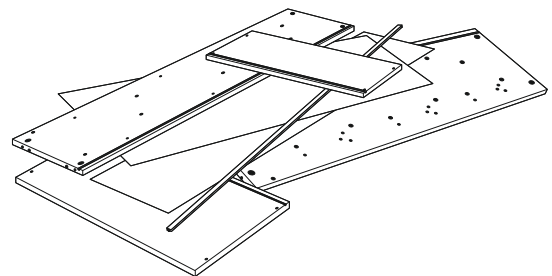
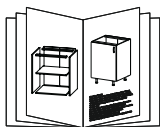
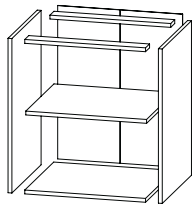
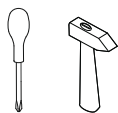
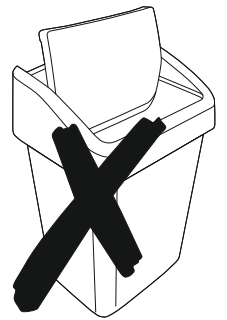
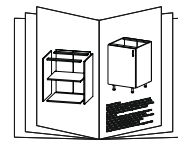
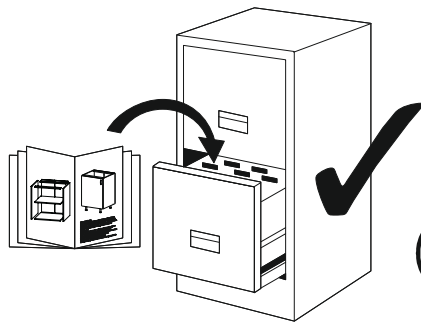
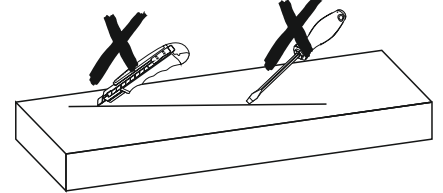
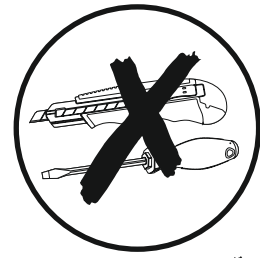
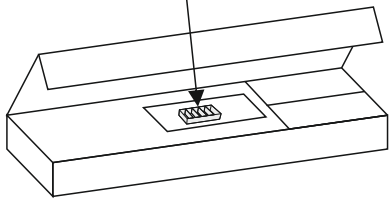
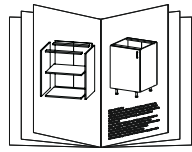

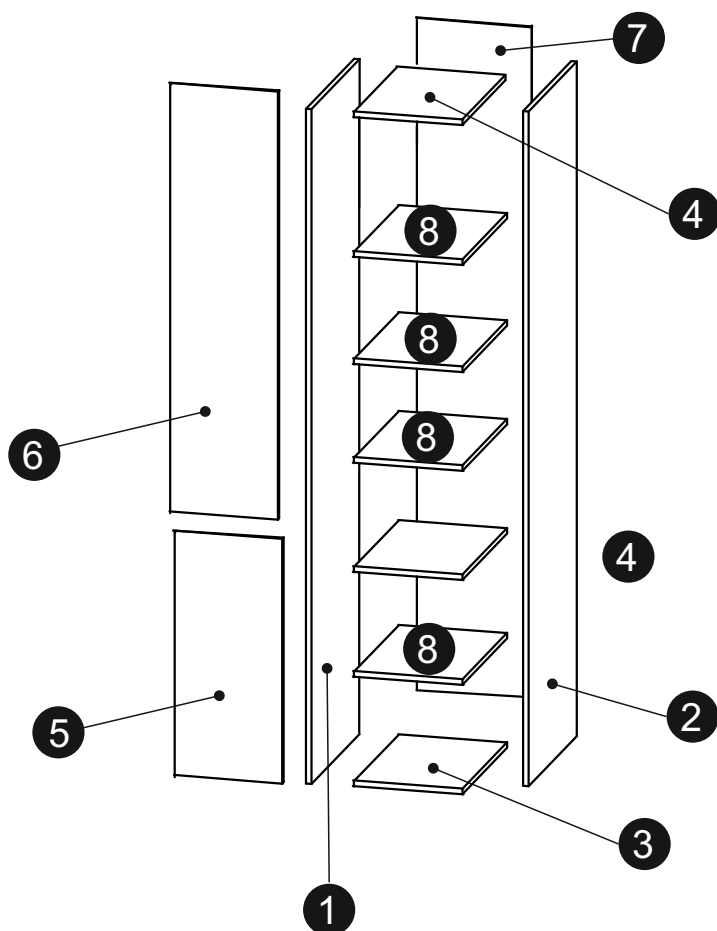

	DLUGOŚĆ LENGTH LÄNGE LONGEUR	SZEROKOŚĆ WIDTH BREITE LARGEUR	GRUBOŚĆ THICKNESS STÄRKE GROSSEUR	ILOŚĆ QUANTITY ANZAHL QUANTITÉ	KOD CODE CODE CODE	PACZKA BOX SCHACHTEL BOÏTE
1	1966	560	18	1		
2	1966	560	18	1		
3	263	556	18	1		
4	263	556	18	2		
5	713	296	18	1		
6	1247	296	18	1		
7	1961	281	3	1		
8	263	550	18	4		

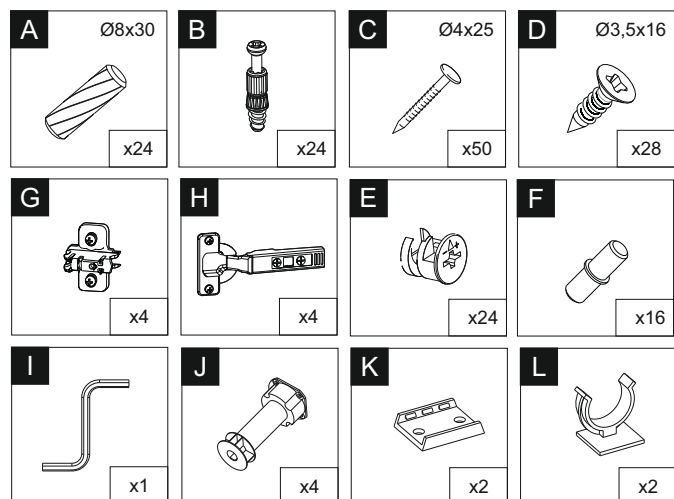

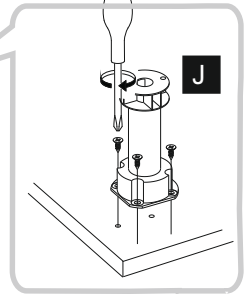
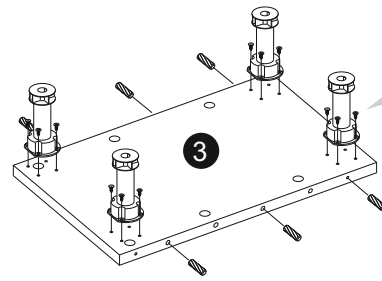
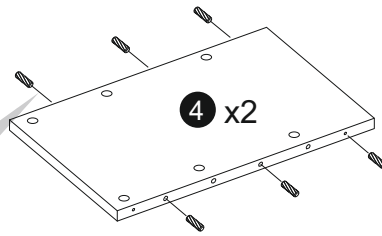
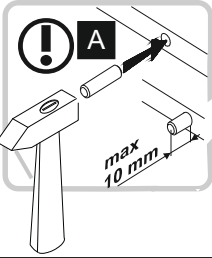
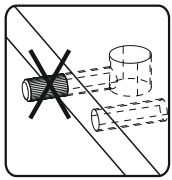

A. D-30-197

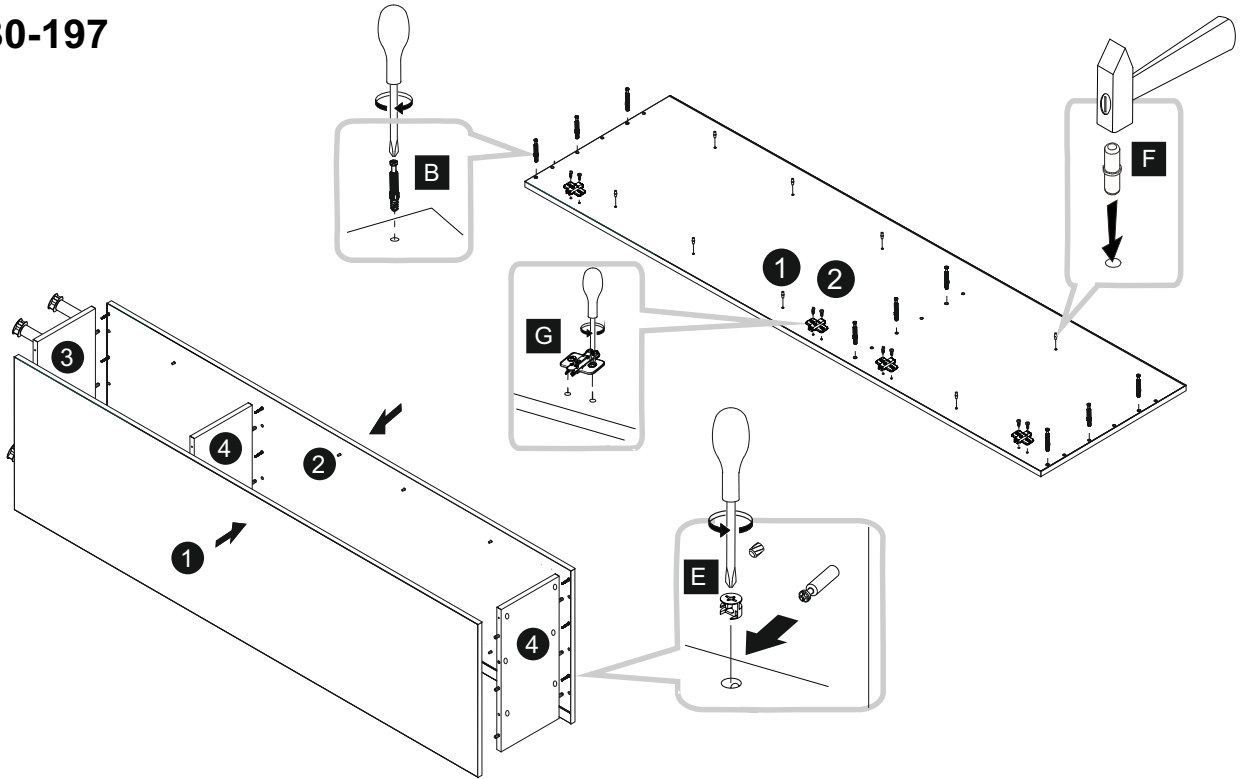

B. DC-30-197

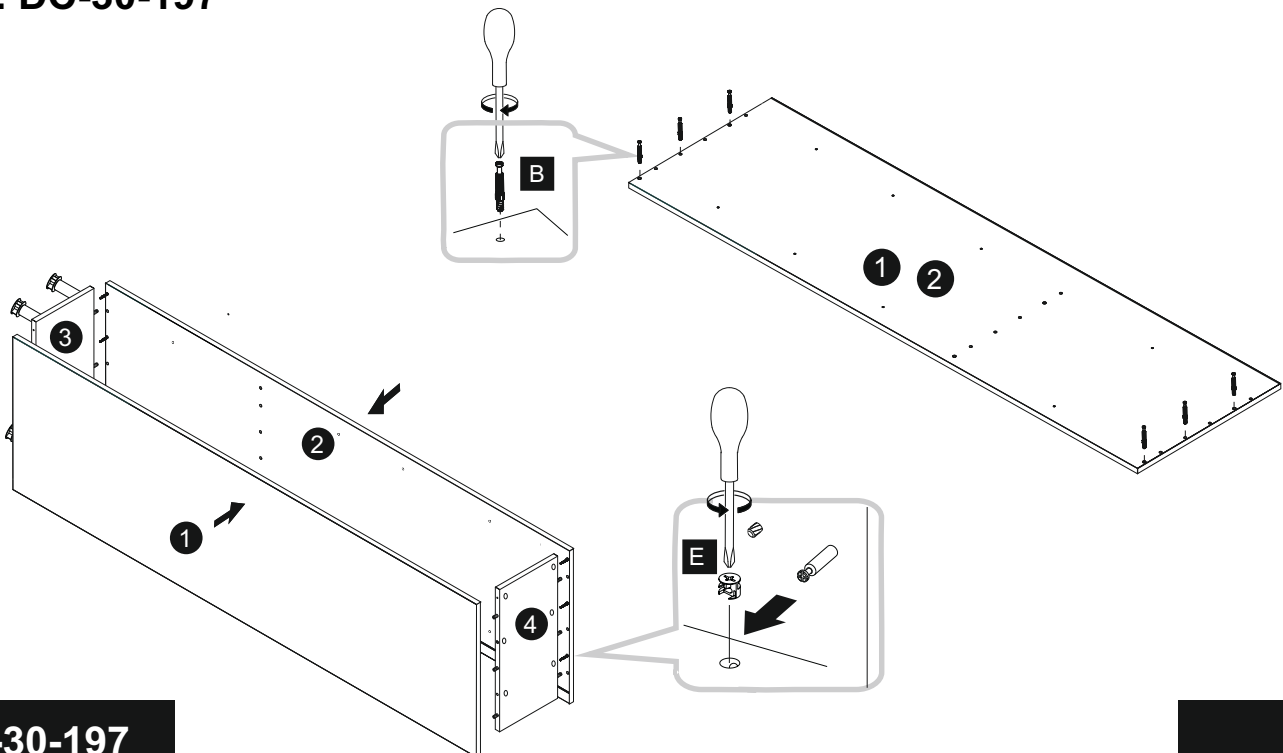

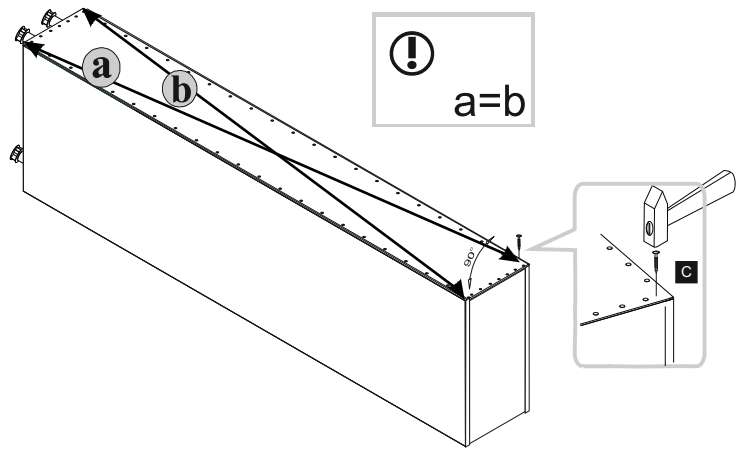
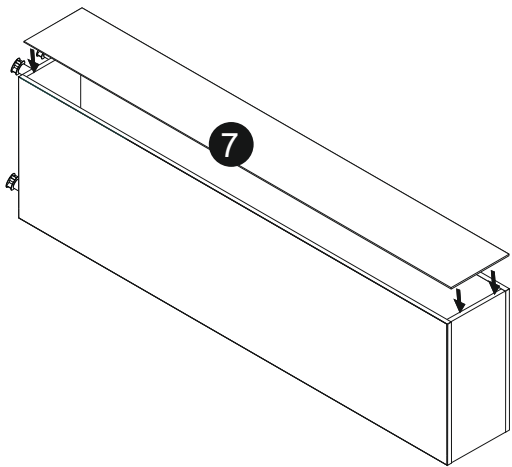

A. D-30-197

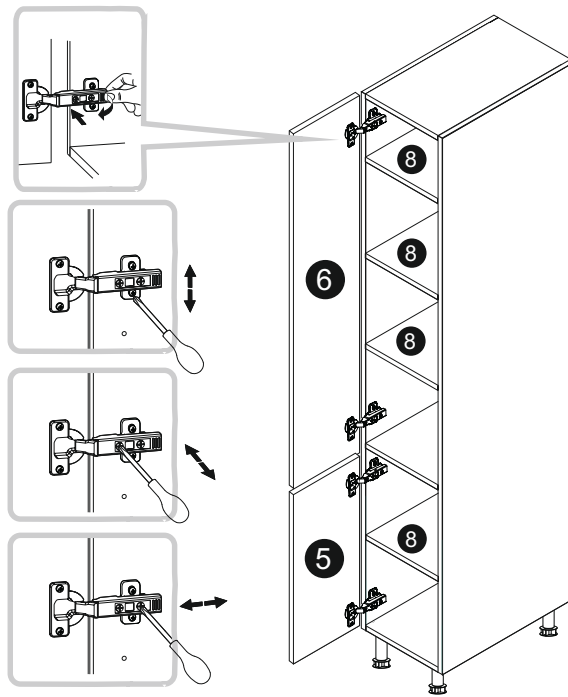
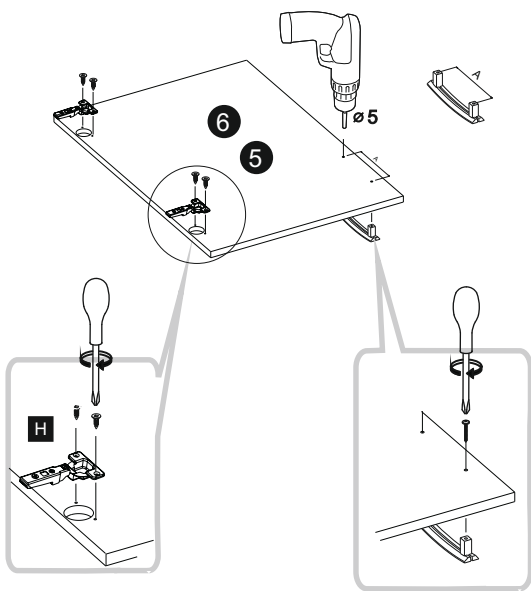

B. DC-30-197

