

①x24



②x12



③x2



④x2



⑤x16



⑥x6



Ax6

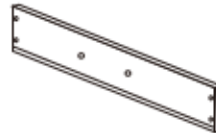

Bx6

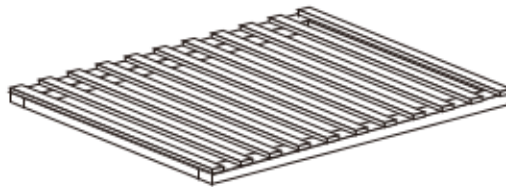

Ex1



Dx2

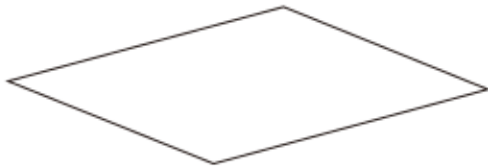

Cx3

1

x3

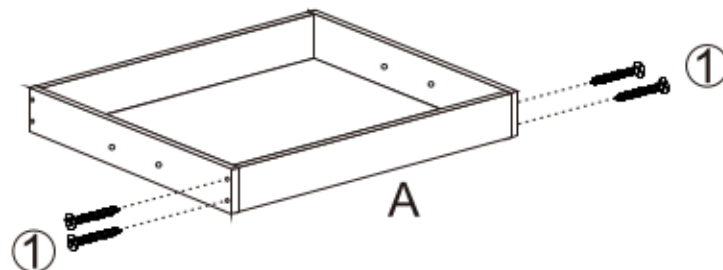
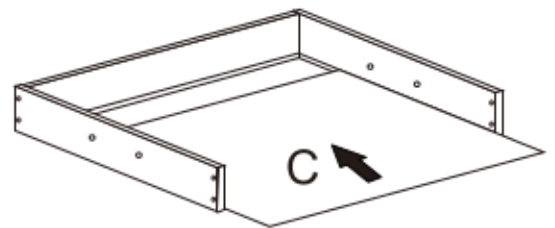
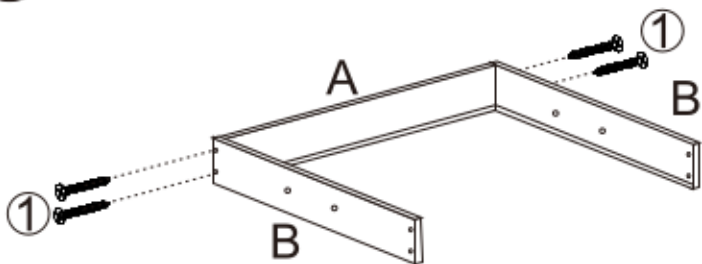

2

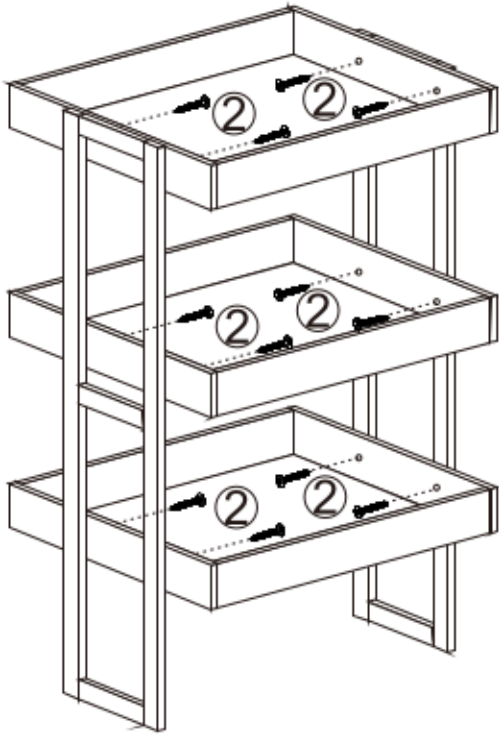

3

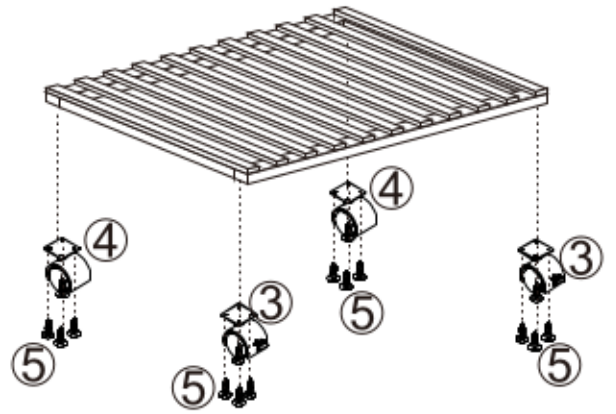

4

