

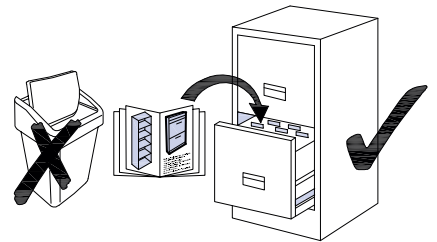

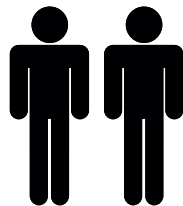

# Modell: Belluno (Gabian)

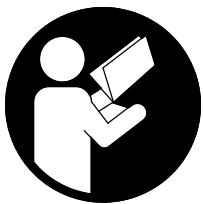

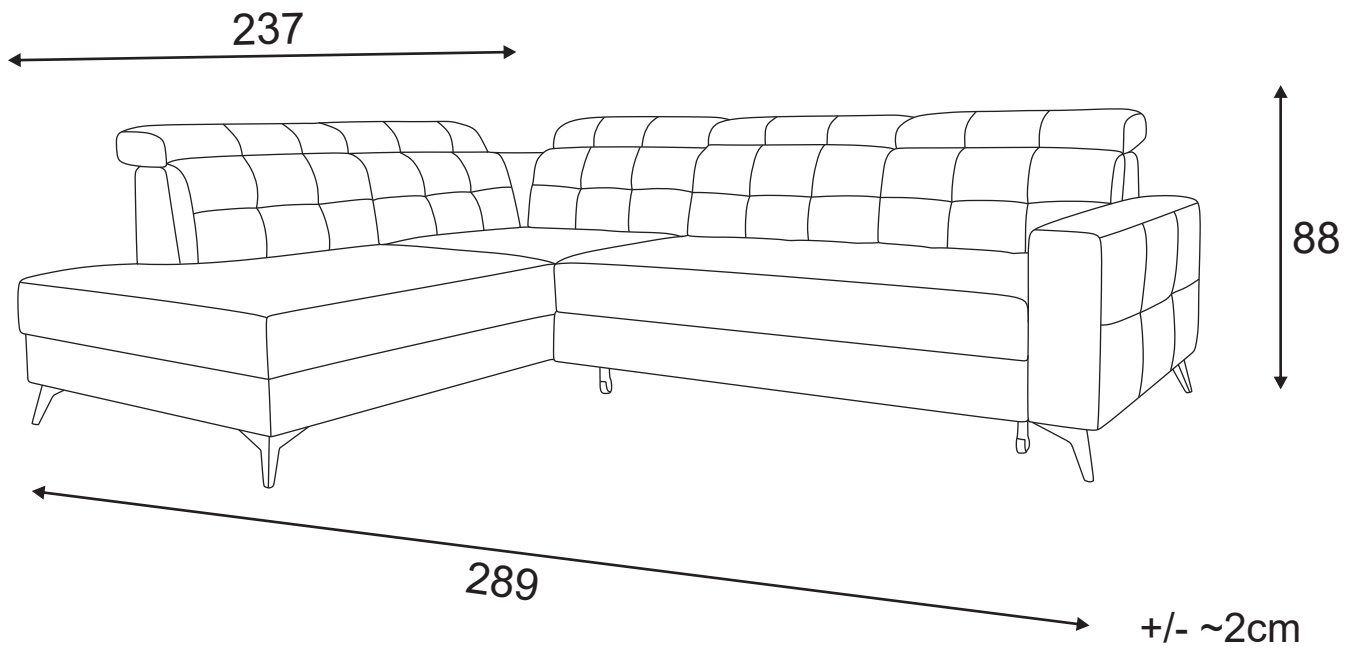

 = (K) x 4szt Nr. 159-H130	 = (P) x 7szt ∅ 50x130	 = (S) x 8szt M.8 x 25	 = 1szt ∅ 5
--	--	--	---

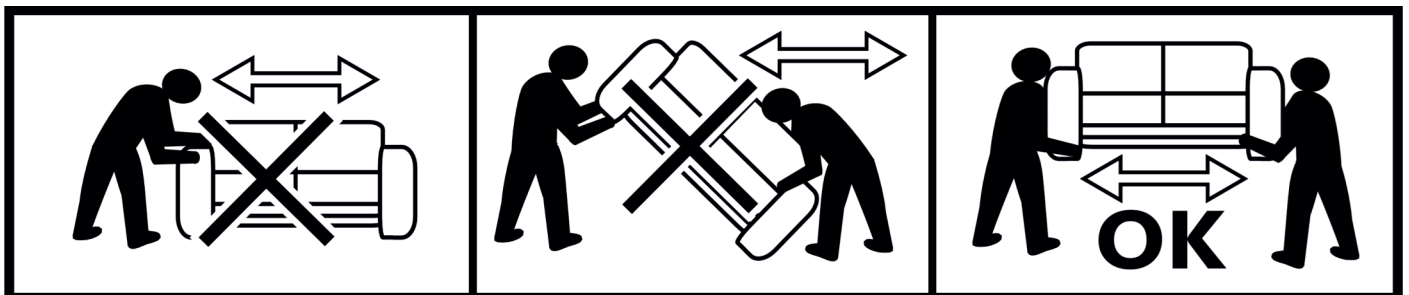
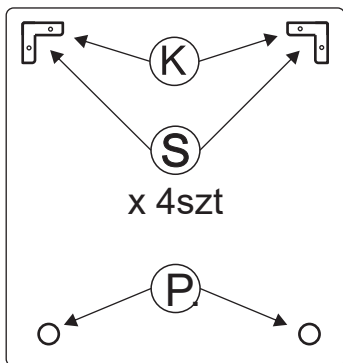
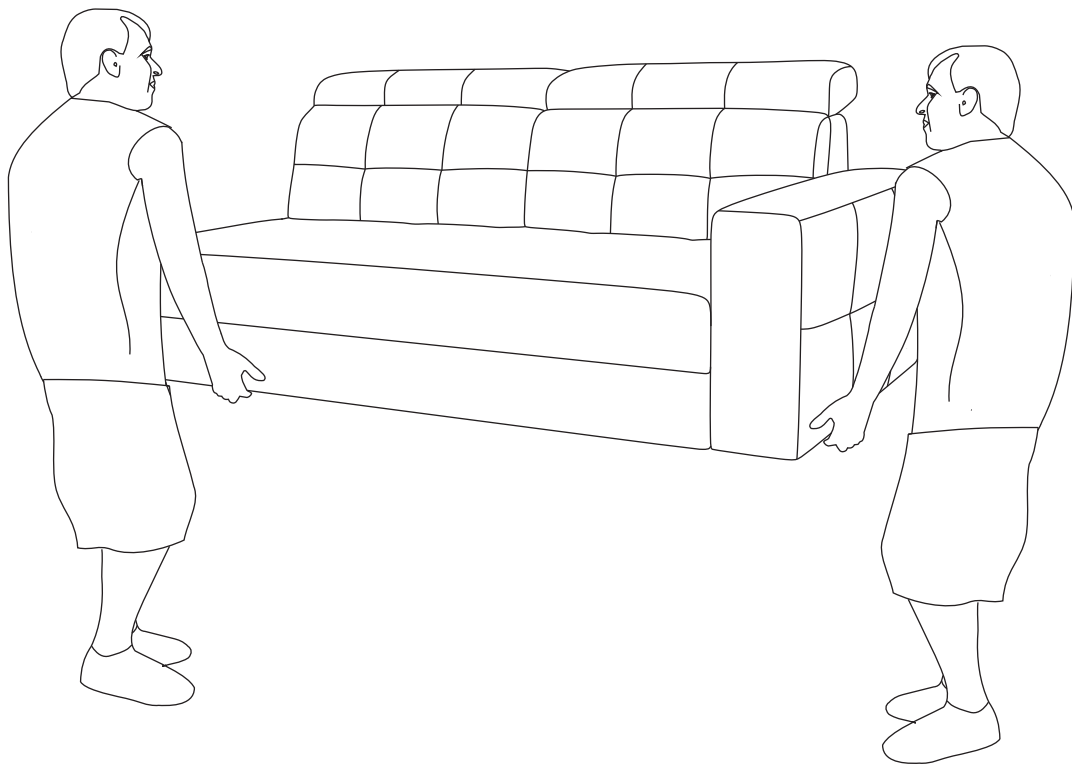



Nr. 159-H130  = (K) x 4szt

∅ 50x130  = (P) x 7szt

M.8 x 25  = (S) x 8szt

∅ 5  = 1szt

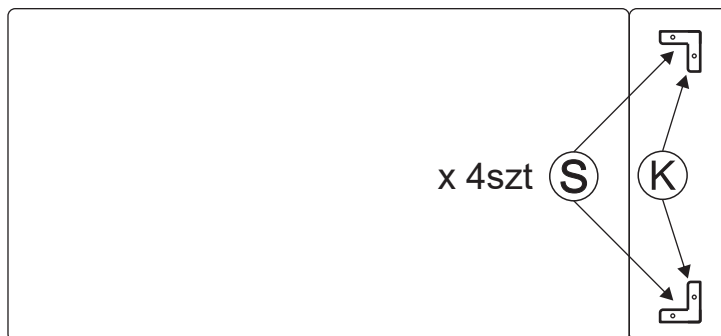
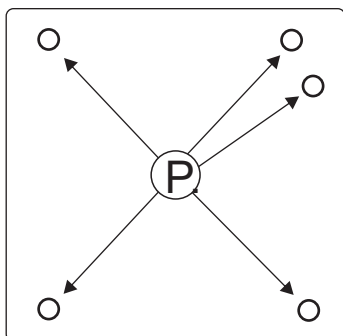

3/7

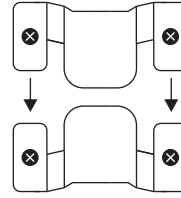

1/2

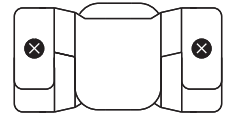

2/2

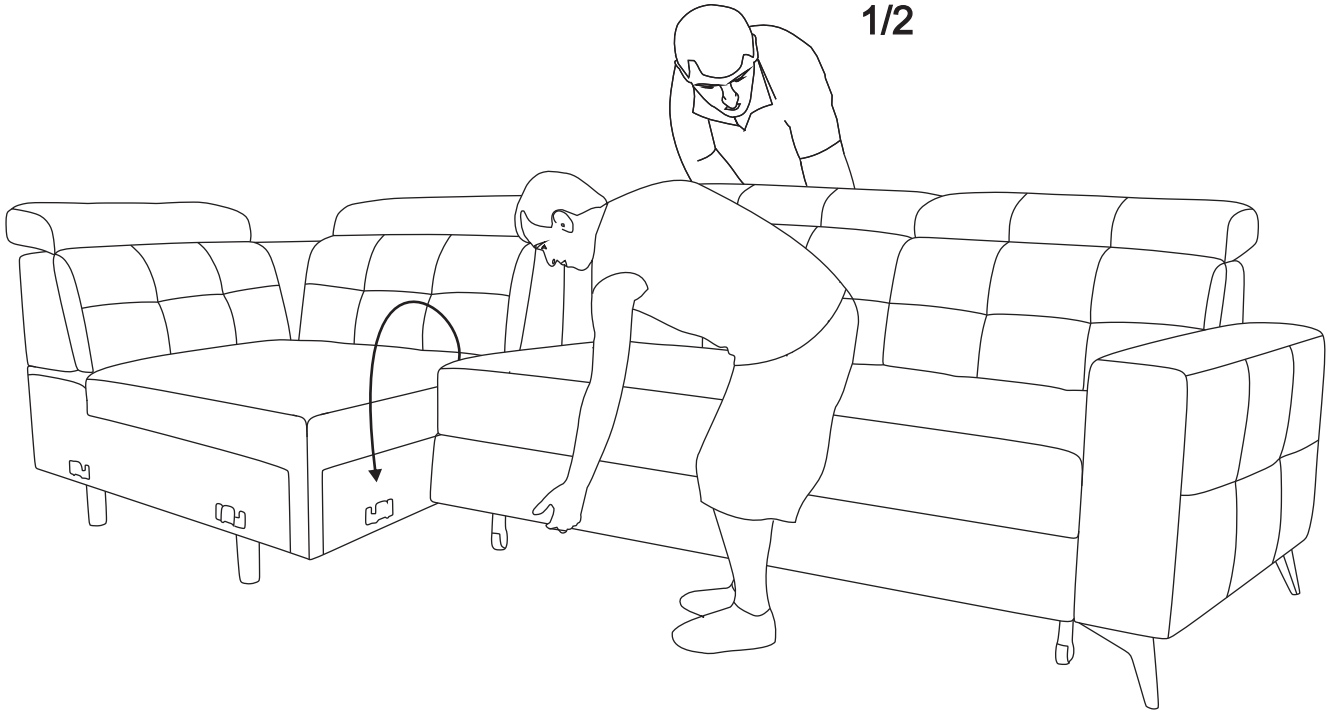

4/7

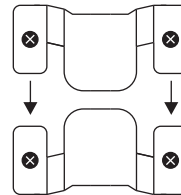

1/2

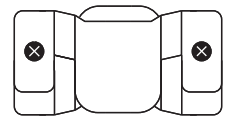

2/2

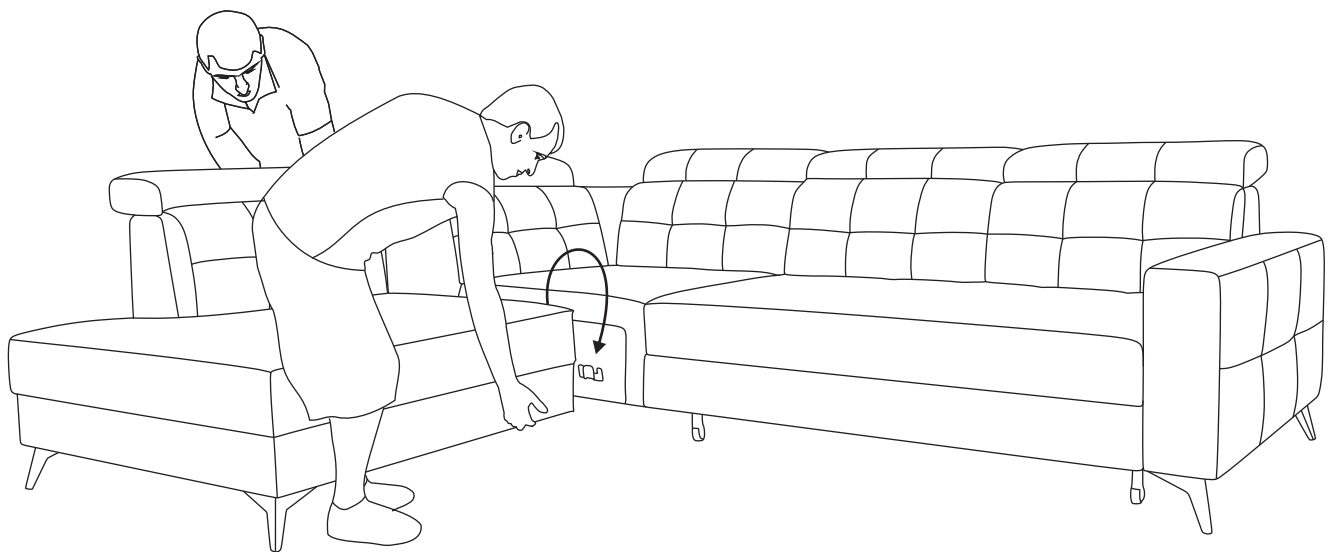

5/7

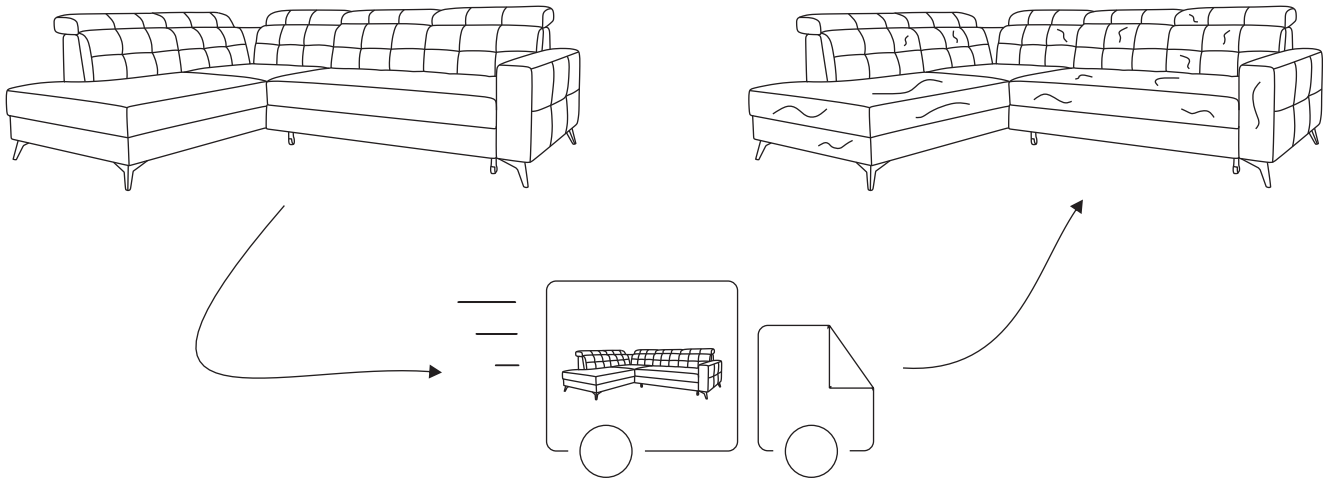

6/7

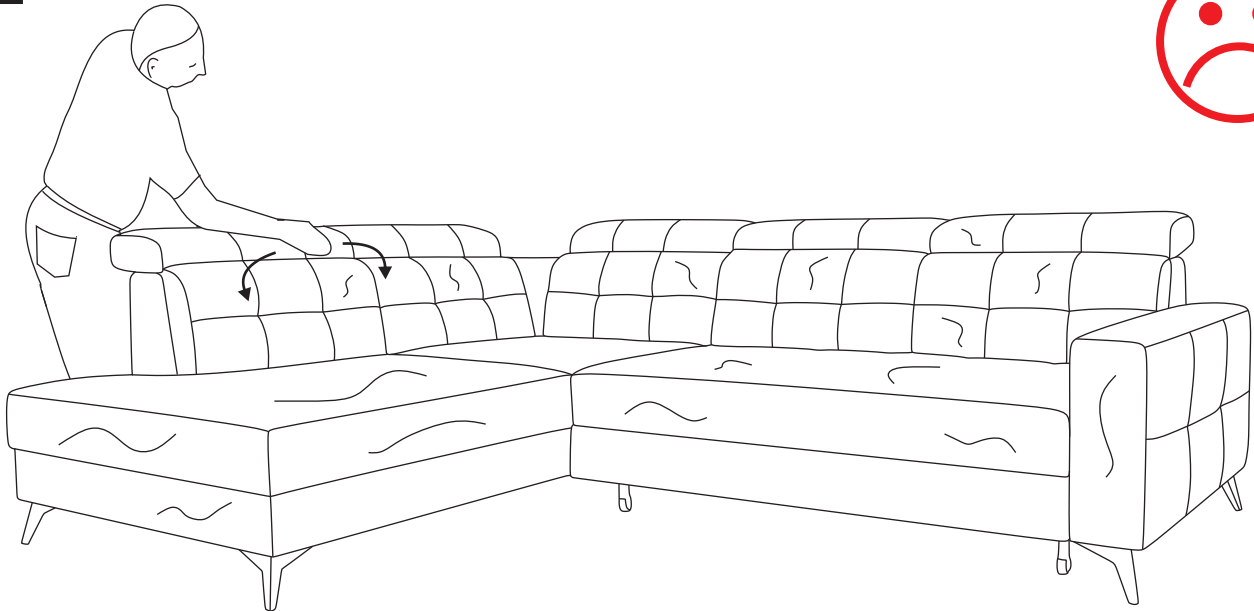

7/7

