

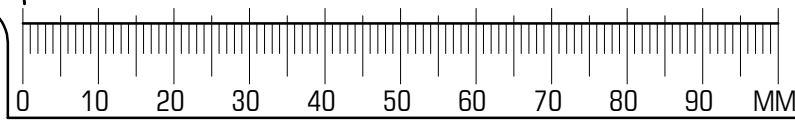

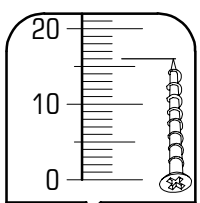

ID EE	ID			
18853	②	1560*264*16	1x	1/2
18854	③	1560*350*16	1x	1/2
18855	④	762*86*16	2x	1/2
18856	⑤	680*330*16	1x	1/2
18857	⑥	680*330*16	1x	1/2
18858	⑦	680*330*16	1x	1/2
18859	⑧	680*330*16	1x	1/2
18860	⑨	1560*350*16	1x	1/2
18861	⑩	706*386*3	2x	2/2
18862	⑪	706*390*3	2x	2/2
18863	⑫	365*300*16	2x	2/2
18864	⑬	386*674*16	2x	2/2
18865	⑭	386*368*16	2x	2/2
18866	⑮	776*150*16	2x	2/2
18819	⑯	300*100*16	2x	2/2
18867	⑰	704*100*16	2x	2/2
18822	⑱	300*100*16	2x	2/2
18868	⑲	306*732*3	2x	1/2

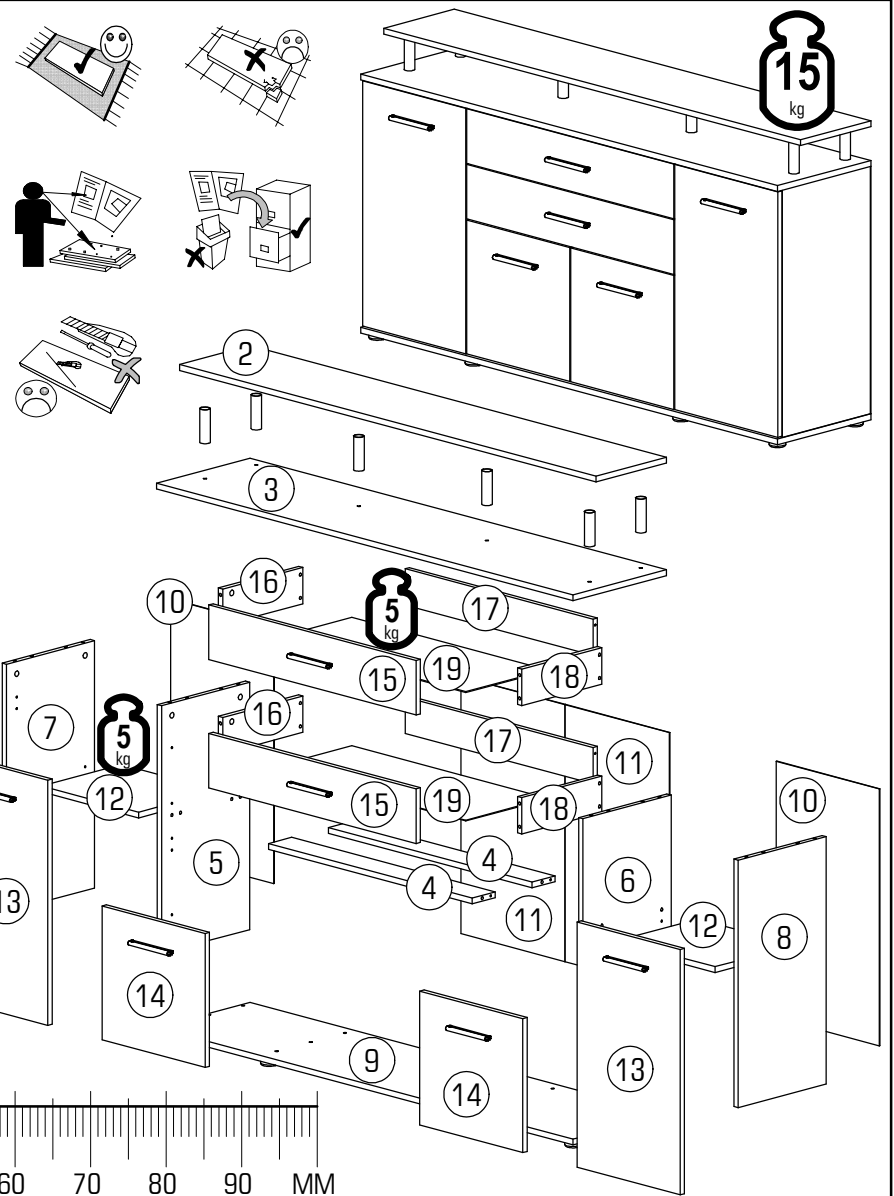
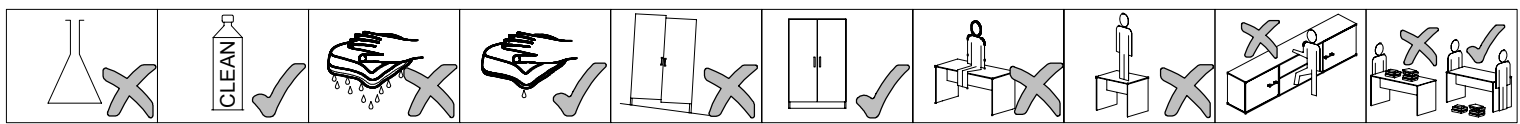
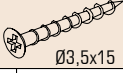

A 50x	B 2x	C 8x	D 32x	E 14x	F 24x	G 12x	H 6x	I 8x	J 2x
L 12x	M 2x	N 8x	P1 16x	P2 16x	Q 16x	R1 4x	R2 4x	S 6x	T 8x
U1 2x	U2 2x	V1 6x	V3 6x	W1 4x	W2 4x	X1 12x	X2 12x	Y 4x	

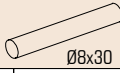

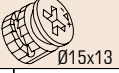
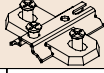
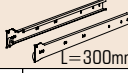
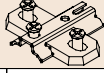

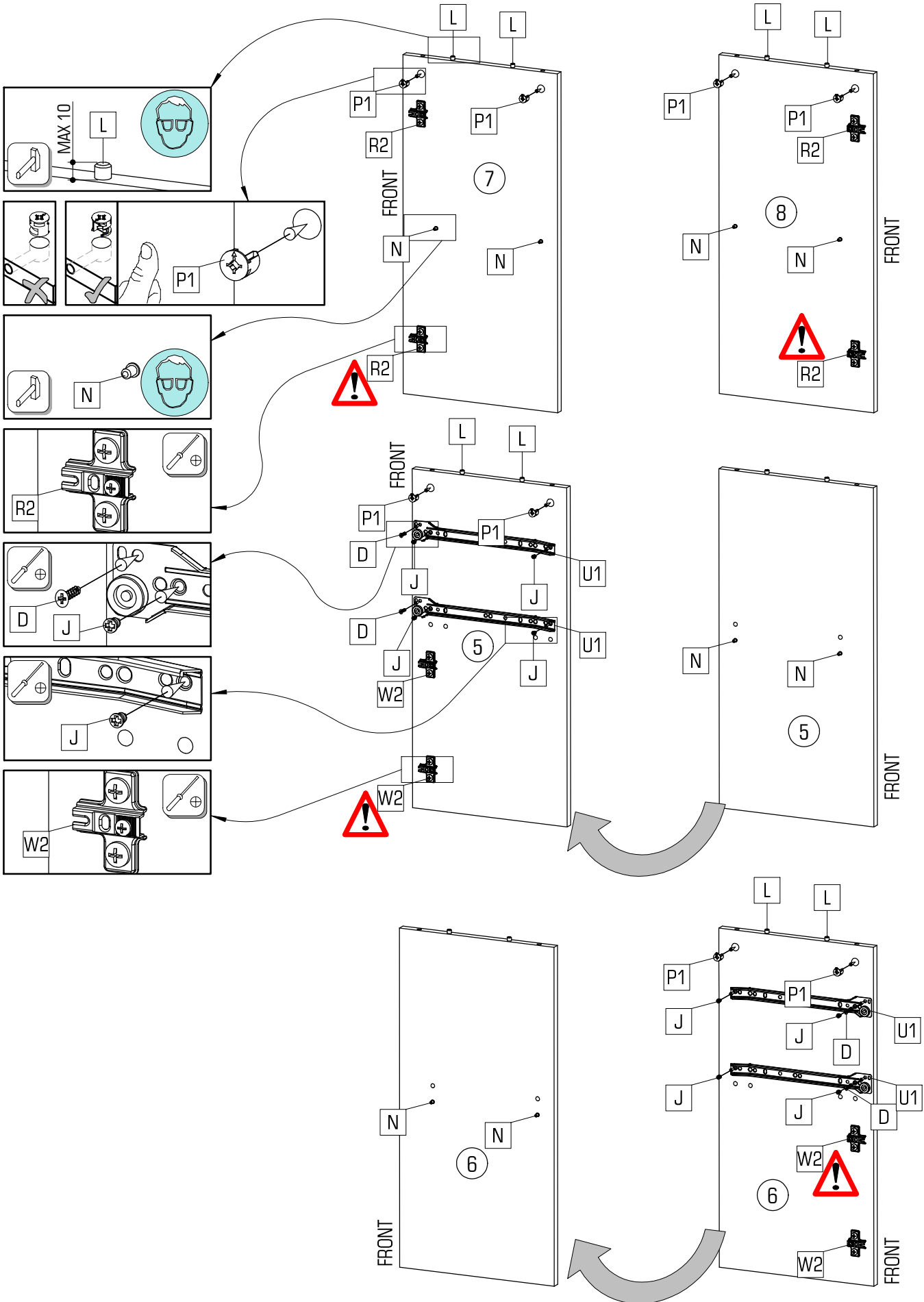
							
D	J	L	N	P1	R2	U1	W2
4x	8x	8x	8x	8x	4x	2x	4x

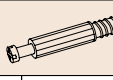

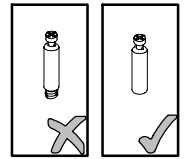
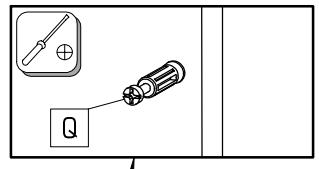
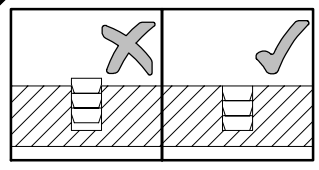
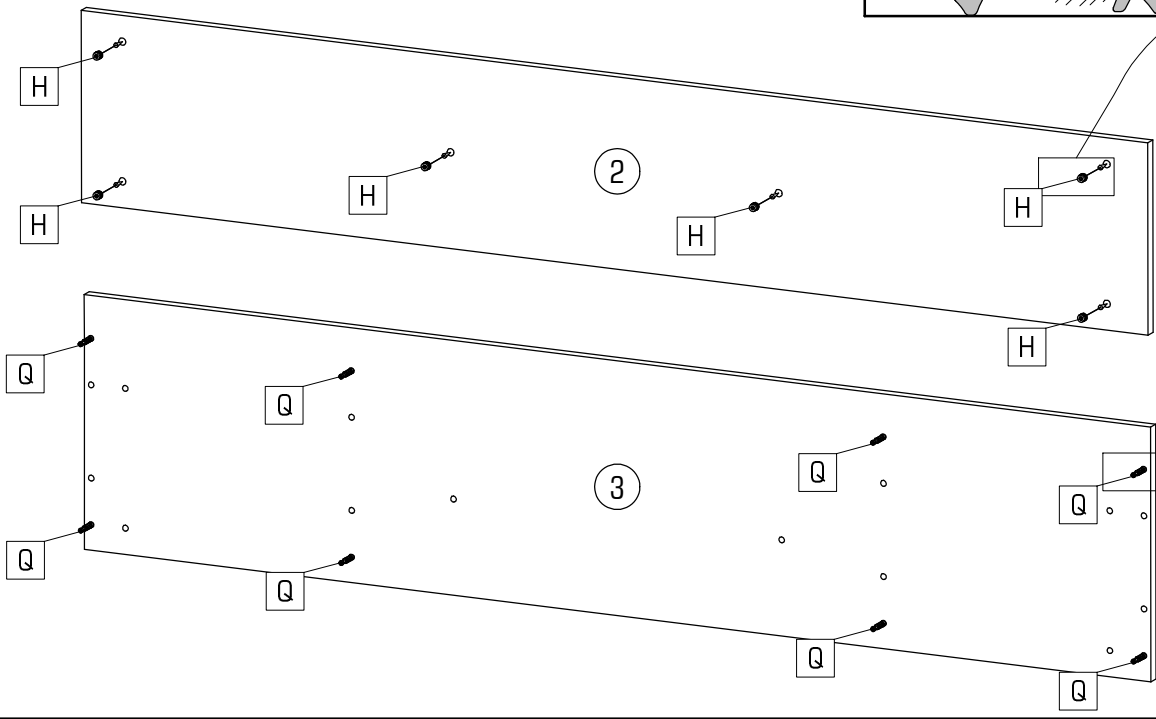
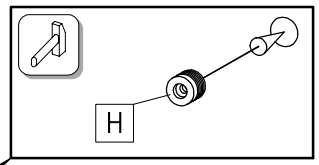
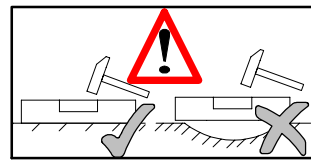

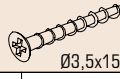
	
H 6x	Q 8x

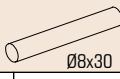
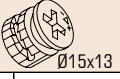
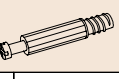
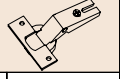
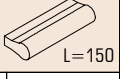
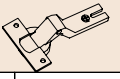

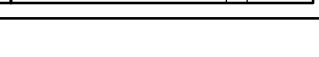
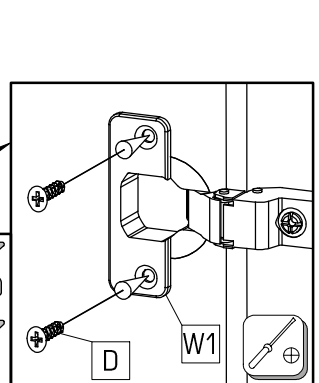
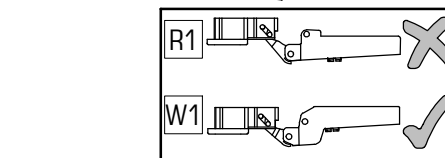
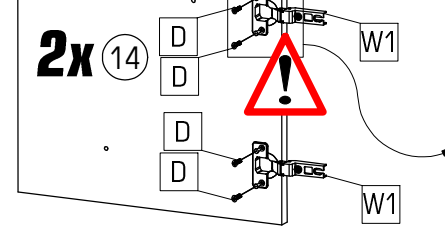
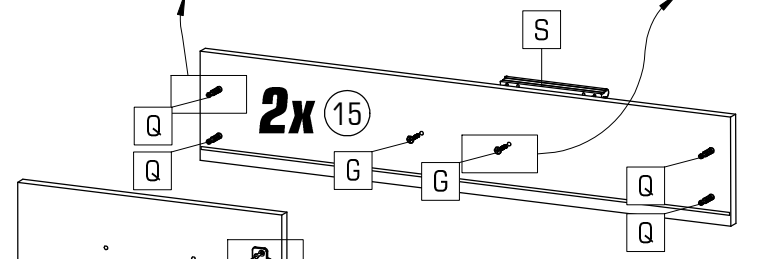
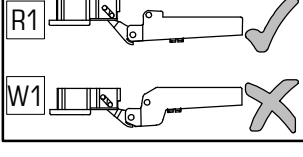
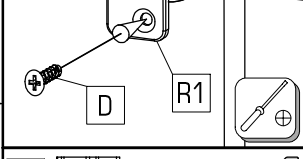
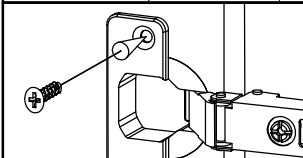
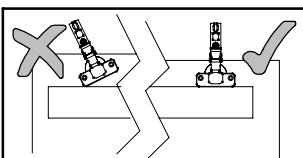
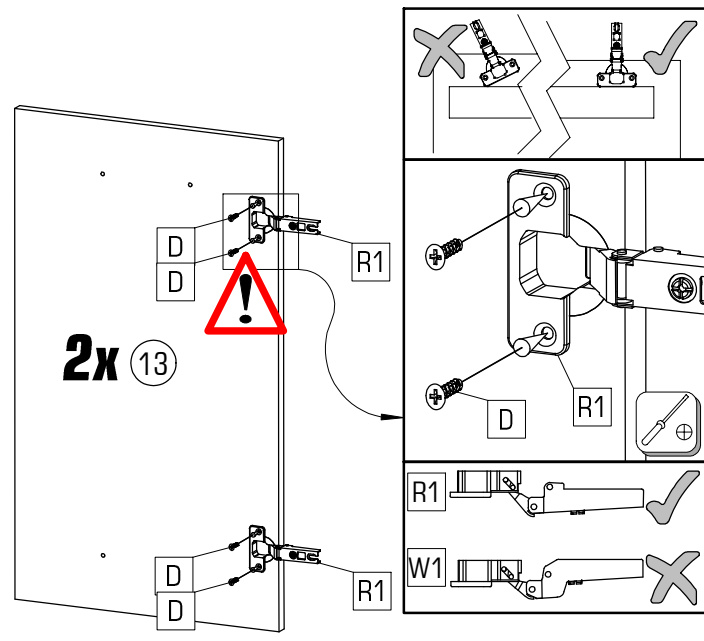
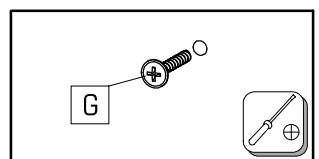
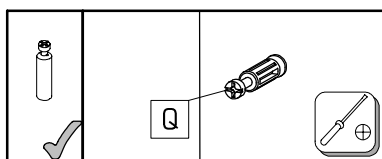
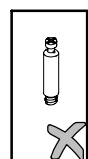
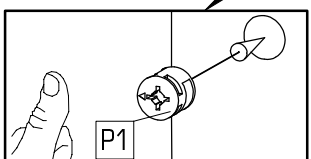
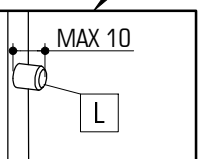
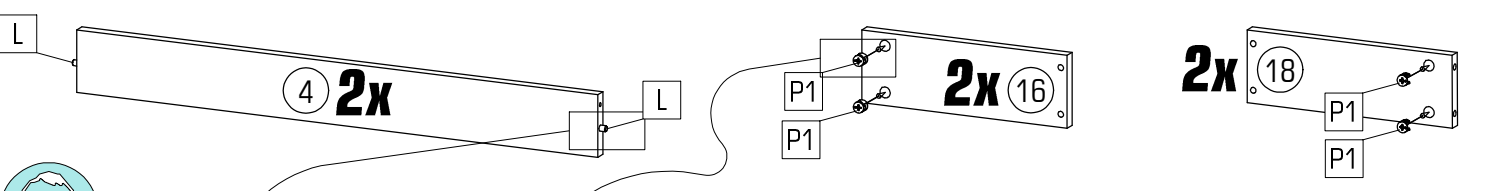
							
D 16x	G 4x	L 4x	P1 8x	Q 8x	R1 4x	S 2x	W1 4x

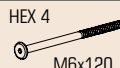

			
Ø3,5x16		L=93	HEX 4 M6x120
E 4x	M 2x	V1 6x	V3 6x

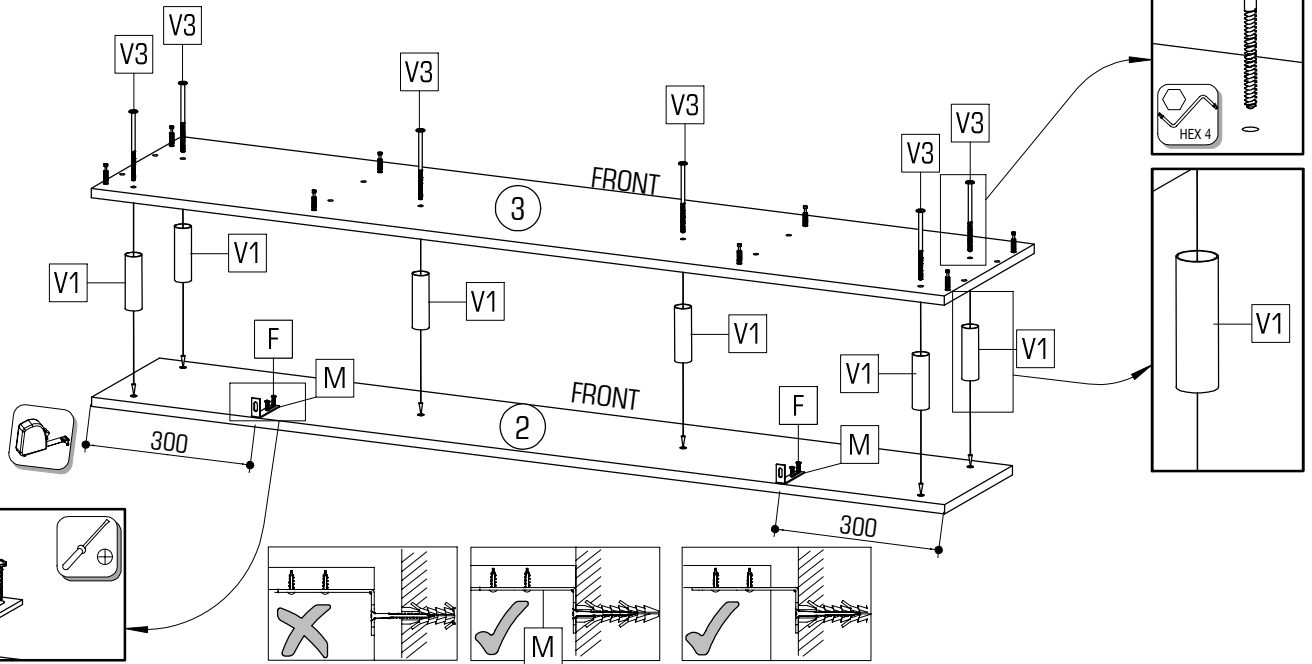

Ø7x50
F 4x

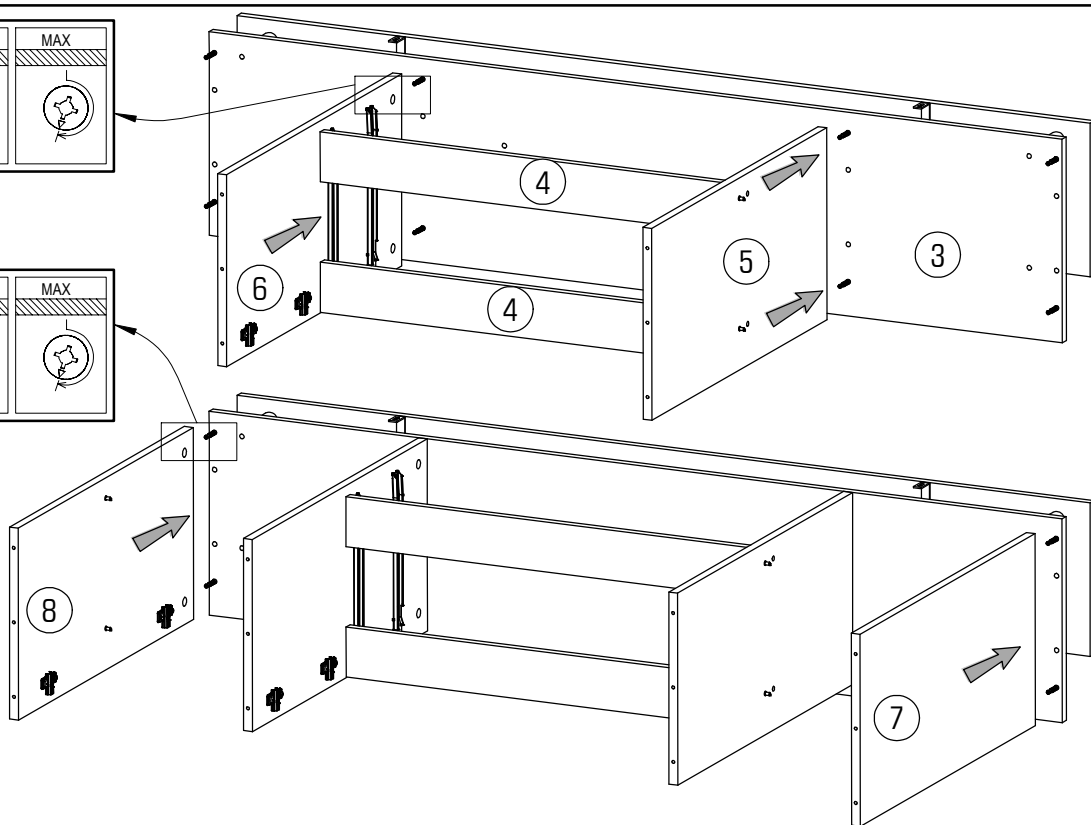
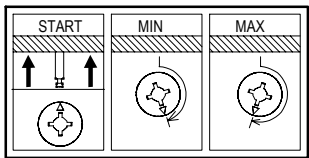
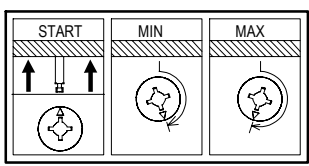
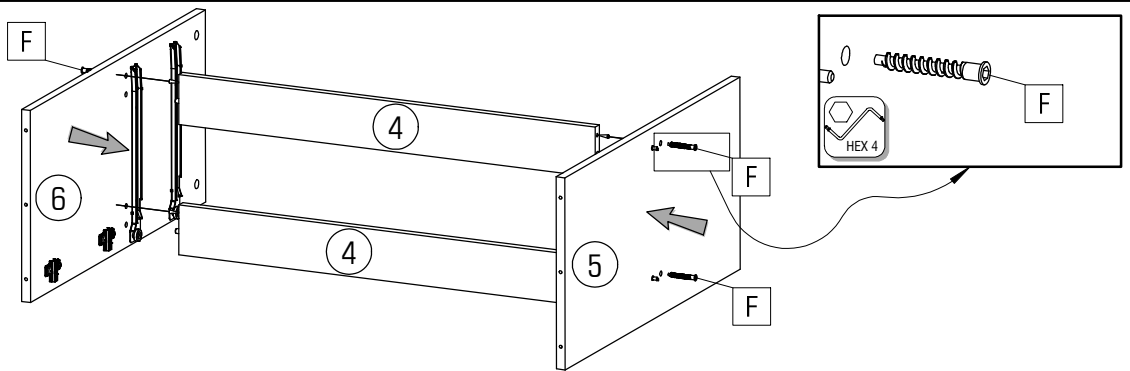

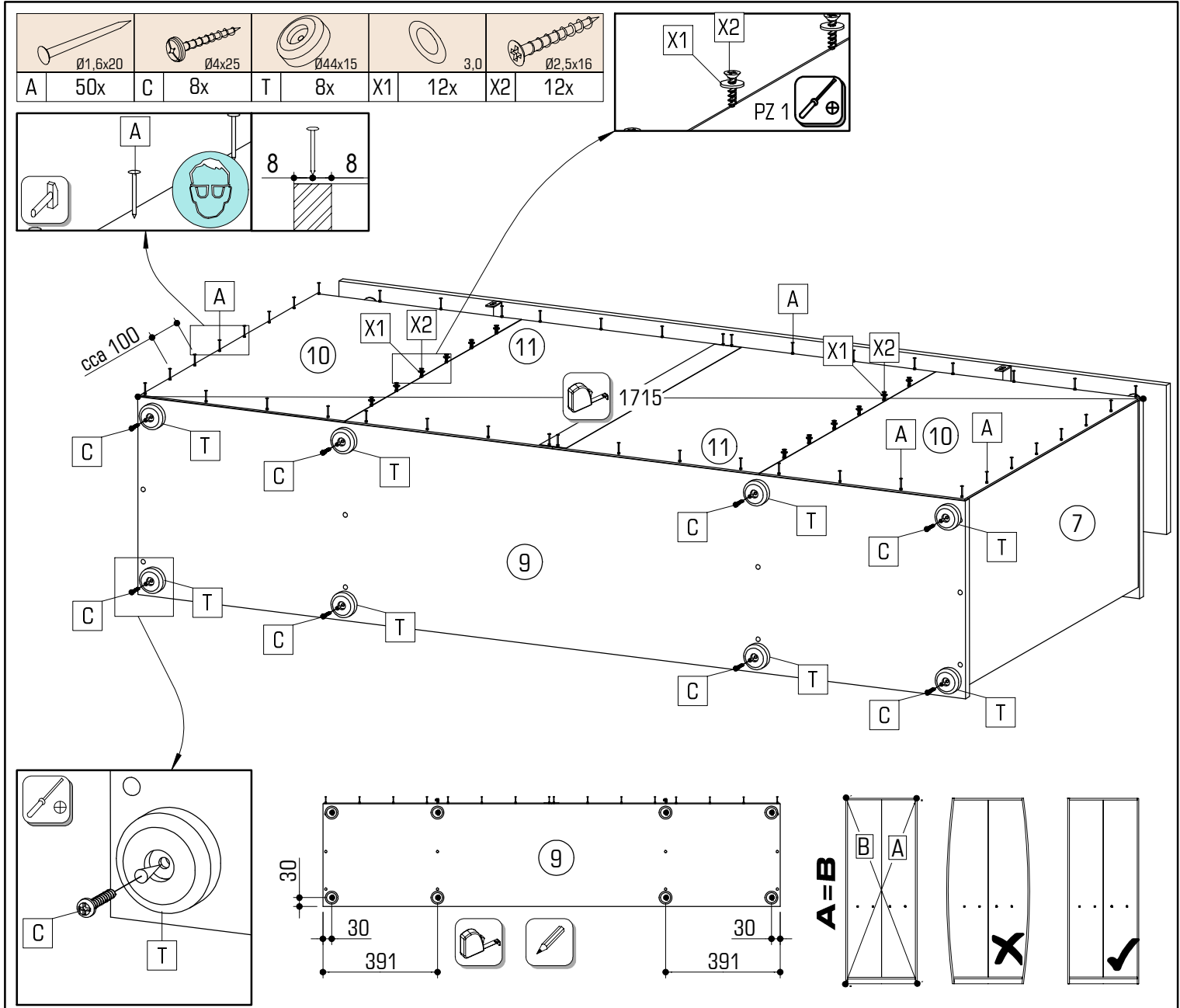
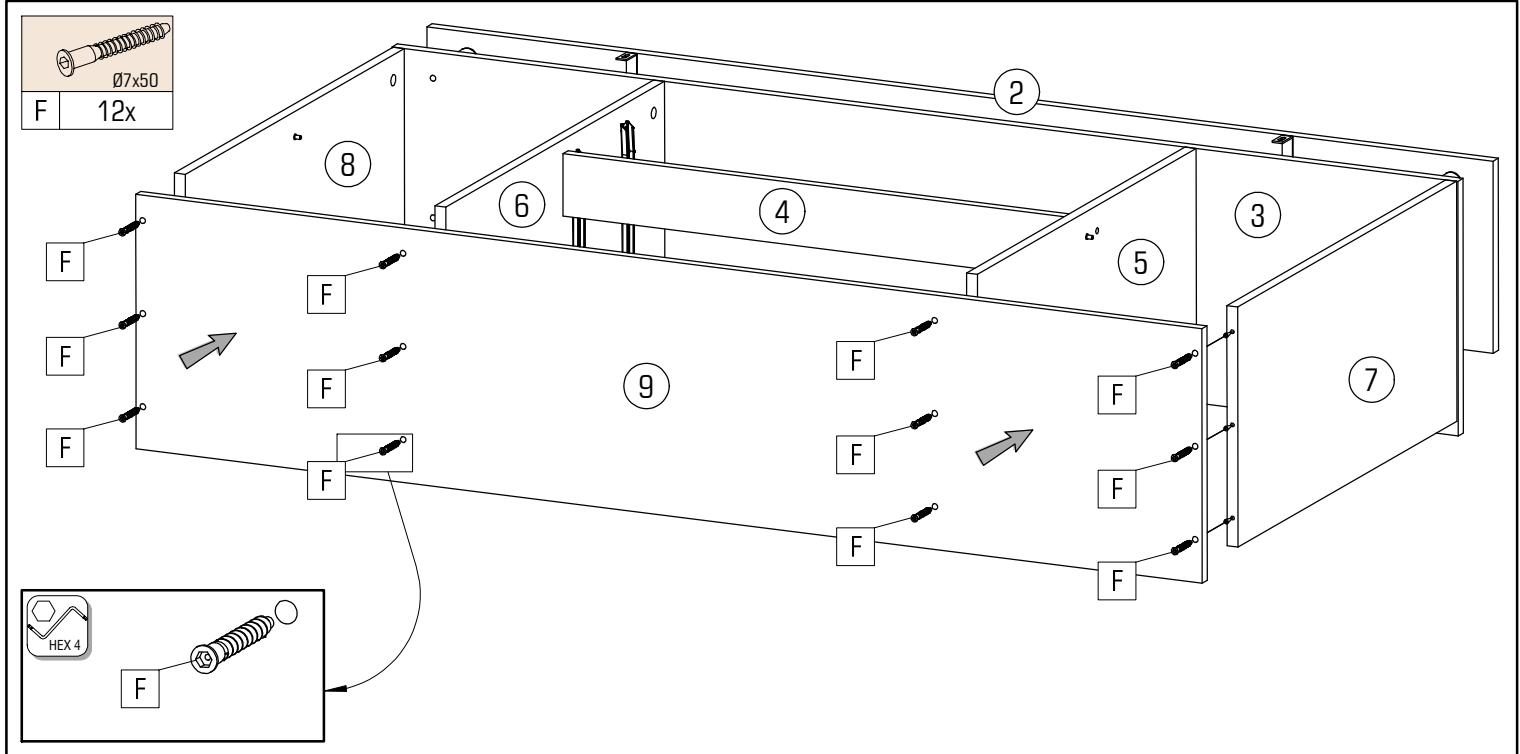



Upozornenie! Pevnosť steny sa musí pred montážou bezpodmienečne skontrolovať. Hmoždinky, ktoré sú v balení, používajte jedine pre pevné murivo ako je betón alebo tehla. Hmoždinky sa nesmú používať v prípade ľahkého stavebného muriva, dutinová tehla, sádrokartónové dosky alebo iných konštrukcií rámu. U týchto murív je nutné použiť špeciálne hmoždinky! Tieto je možné dostať v predajniach so stavebným materiálom (stavebniny). Pri nedodržíaní pokynov nepreberajú výrobcovia/predajci a dodávatelia zodpovednosť za vzniknuté škody.

Upozornění! Před montáží je nutné zkontrolovat stav stěny. Příložené hmoždinky jsou určeny pouze k použití pro pevné zdivo jako beton/cihly. Hmoždinky do zdi se nesmí používat u dutinová cihla, zdiva jako pórovitý stavební kámen, sádrokartónová deska nebo jiný měkký materiál. U těchto zdív jsou nutné použít speciální hmoždinky! Jsou k dostání v prodejních se stavebním materiálem. Při nedodržení těchto pokynů výrobce/prodejce a dovozce neručí za způsobené škody.

Pañnja! Prije montaže obvezno provjerite svojstvo zida. Priložene univerzalne tiplje namijenjene su isključivo za masivne zidove od betona/opeke. Tiplje za masivne zidove ne smiju se koristiti za zidove kao npr šupljina opeka laka sastavni elementi, gips-kartonske ploče ili drugi modularni načini gradnje. Za te zidove potrebne su eventualno specijalne tiplje! Iste su dostupne u trgovinama građevinskim materijalom. U slučaju nepridržavanja prethodno navedenih napomena, proizvođač/trgovac i uvoznik ne preuzimaju odgovornost!

Achtung! Die Wandbeschaffenheit ist vor der Montage unbedingt zu prüfen. Die beigelegten Universaldübel sind ausschließlich nur zur Verwendung für festes Mauerwerk wie Beton/Ziegel. Die Mauerdübel dürfen nicht bei Mauerwerk wie Hohlraumziegel, Leichtbausteinen, Gipskartonplatte oder anderer Rahmenbauweise verwendet werden. Bei diesen Mauerwerken sind gegebenenfalls Spezialdübel zu verwenden! Diese sind in einem Fachgeschäft (Baumarkt) erhältlich. Bei Nichteinhaltung wird seitens Produzenten/Händler und Importeur keine Haftung übernommen.

Vigyázat! Szerelés előtt a falfelületet feltétlenül vizsgálja meg. A mellékelt univerzális tiplik kizárólag stabil falazathoz használható mint például beton/tégla. A fali tiplik nem használható könnyű építőkövekhez, üreg tégla, gipszkarton lapokhoz vagy más fűvázás építményekhez. Ezekhez a falfelületekhez csak speciális tiplik használhatóak, melyek szaküzletekben (barkácsruházakban) beszerezhetőek. Fentiek figyelmen kívül hagyása esetén a gyártó/kereskedő vagy forgalmazó nem vállal felelősséget.

Uwaga! Ścianę należy sprawdzić przed montażem. Dołączone uniwersalne kołki rozporowe są odpowiednie tylko do stosowania w mocnych murach, takich jak beton lub cegła. Nie robć za pomocą kołków rozporowych murowanych, takich jak pustak, lekka kostka, powierzchnie takie jak płyty gipsowo-kartonowe lub inne systemy ram. Jeśli dotyczy, muszą to być określone kołki rozporowe być użytym! Są one dostępne w specjalistycznym sklepie (sklepie ze sprzętem) niezgodność, producent / sprzedawca lub importer nie ponoszą odpowiedzialności.

Prudență! Zidul trebuie examinat înainte de asamblare prizele de perete sunt adecvate numai pentru utilizarea în zidărie feră, cum ar fi betonul bloc sau cărămida. Nu folosiți zidăria zidurilor de perete, cum ar fi cărămida goală, blocul ușor, suprafețe cum ar fi gips-carton sau altă încălcare sisteme. Dacă este cazul, trebuie folosite anumite prize de perete! Acestea sunt disponibile la un magazin specializat (magazin de hardware). În caz de nerespectare, producătorul / vânzătorul cu amănuntul sau importatorul nu își asumă răspunderea.

Увага! Стан стіни необхідно перевірити перед установкою. Укладені універсальні дюбелі призначені лише для використання з фіксованими Кладка, як бетон / цегла. Анкери для стін не повинні використовуватися для кладки Порожни цегли, легкі будівельні блоки, гіпсокартон або інша каркасна конструкція бути використаними. З цією кладкою можуть застосовуватися спеціальні дюбелі використання! Вони доступні в спеціалізованому магазині (магазині апаратних засобів) Виробник / дилер та імпортер не несе відповідальності.

Ø5,0x70	Ø10	
B	2x	K
		2x
P2		8x

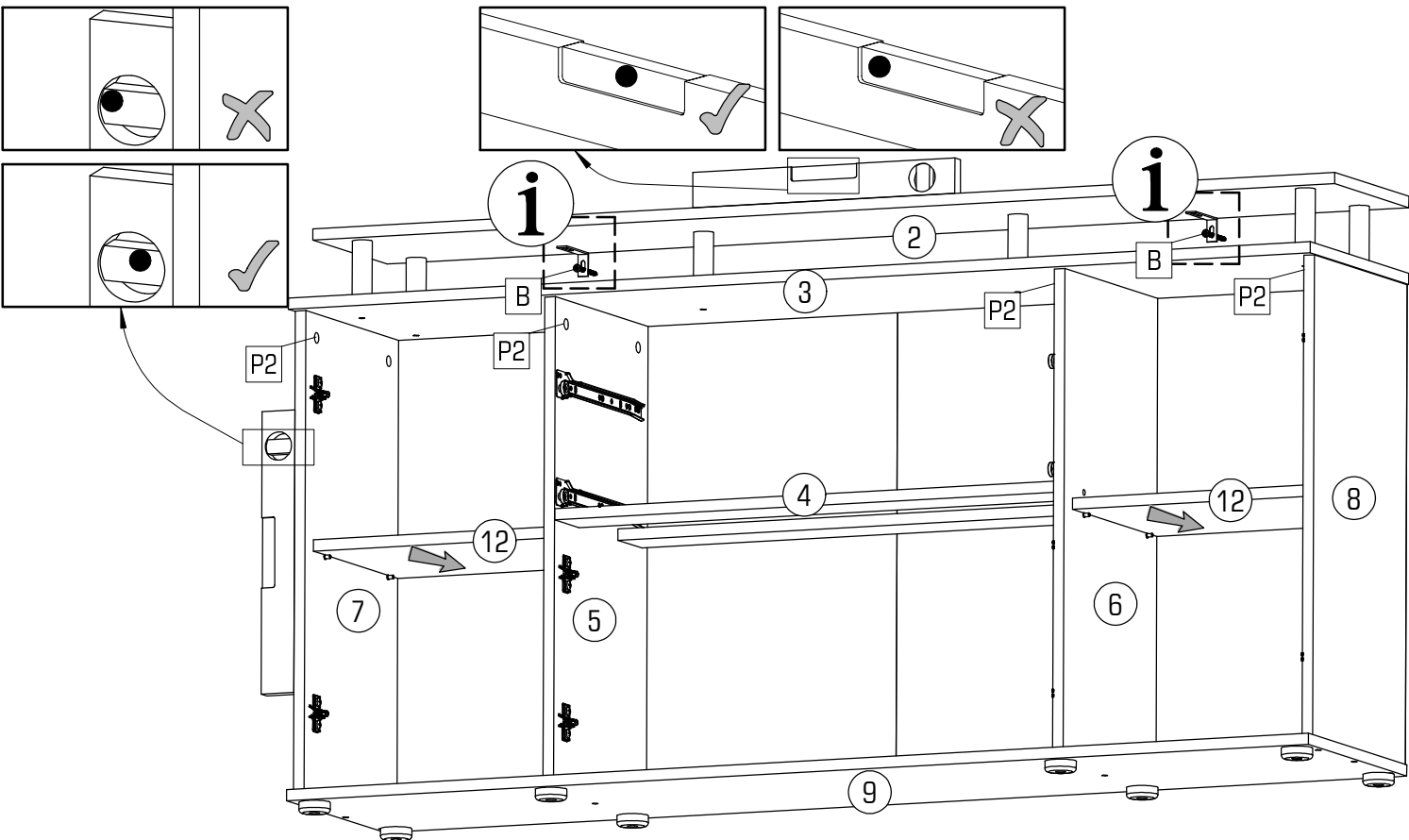
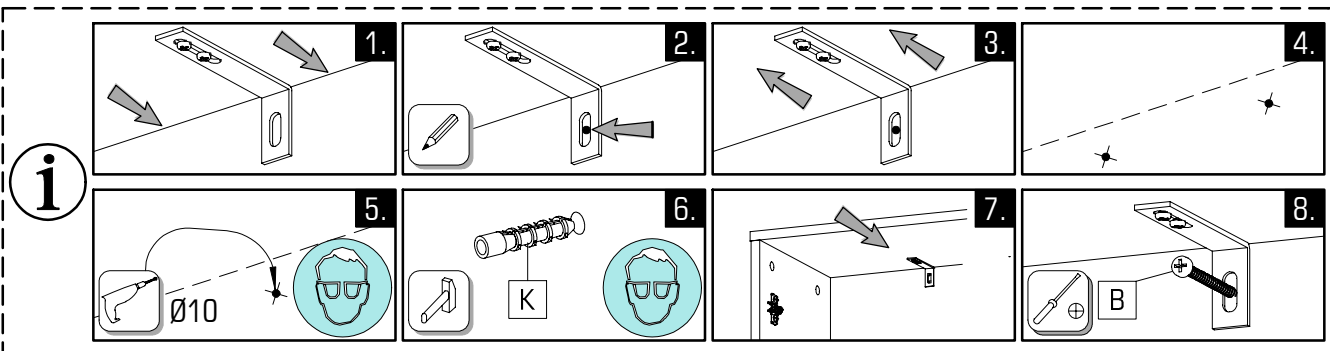
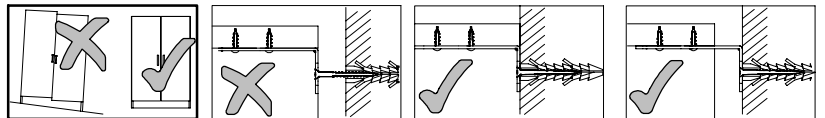

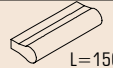

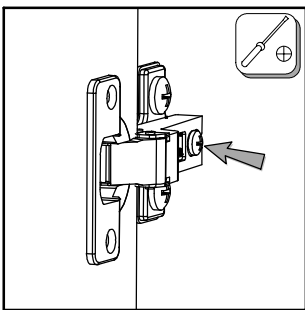
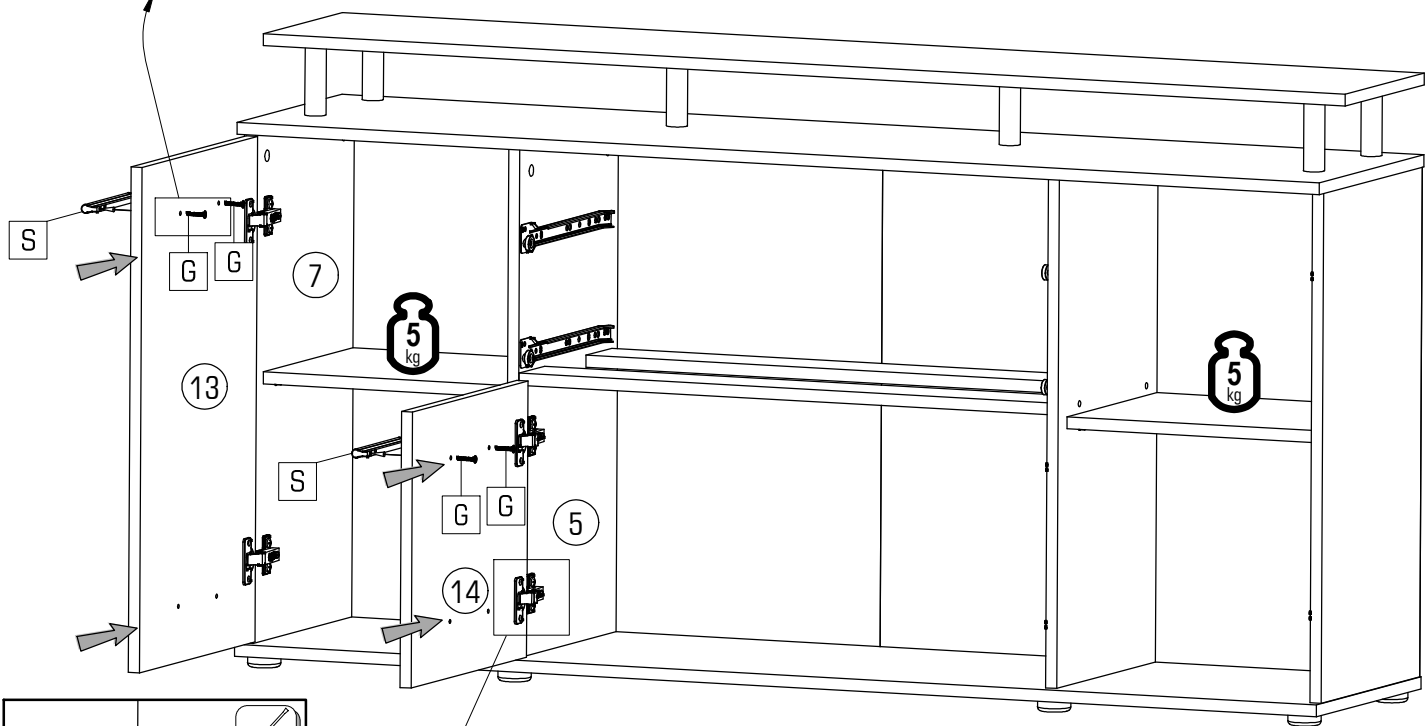
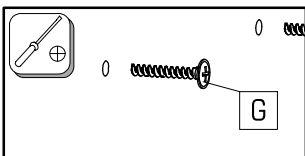
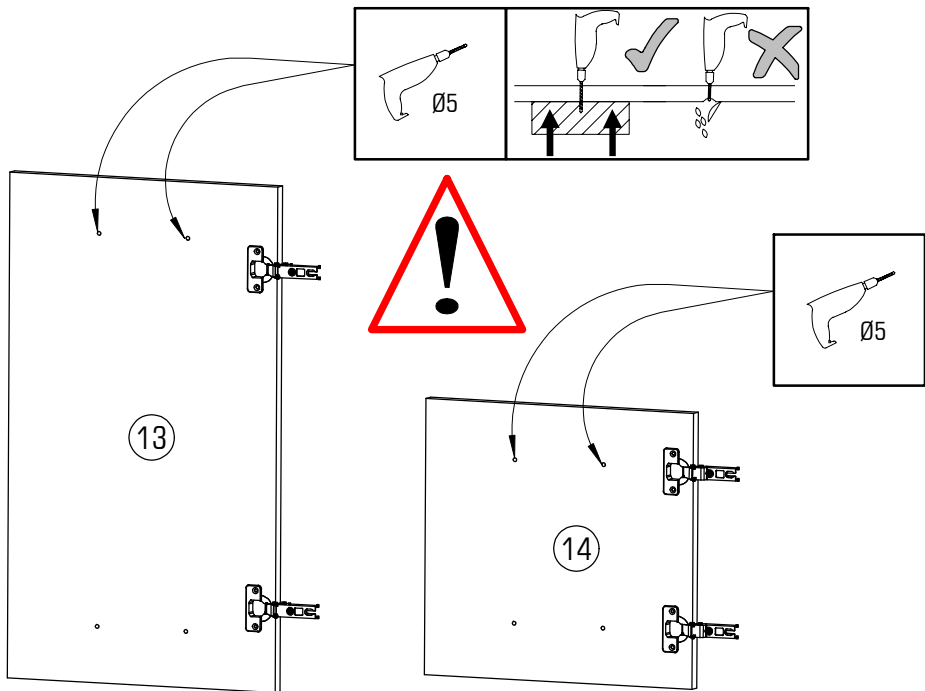
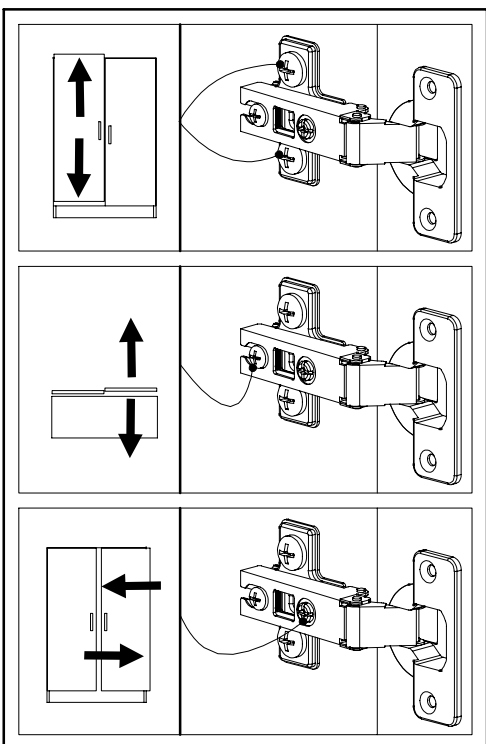

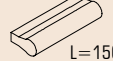

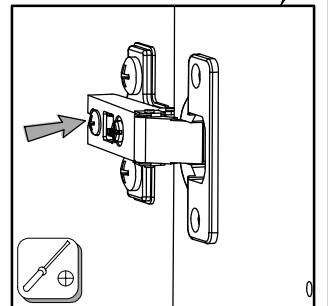
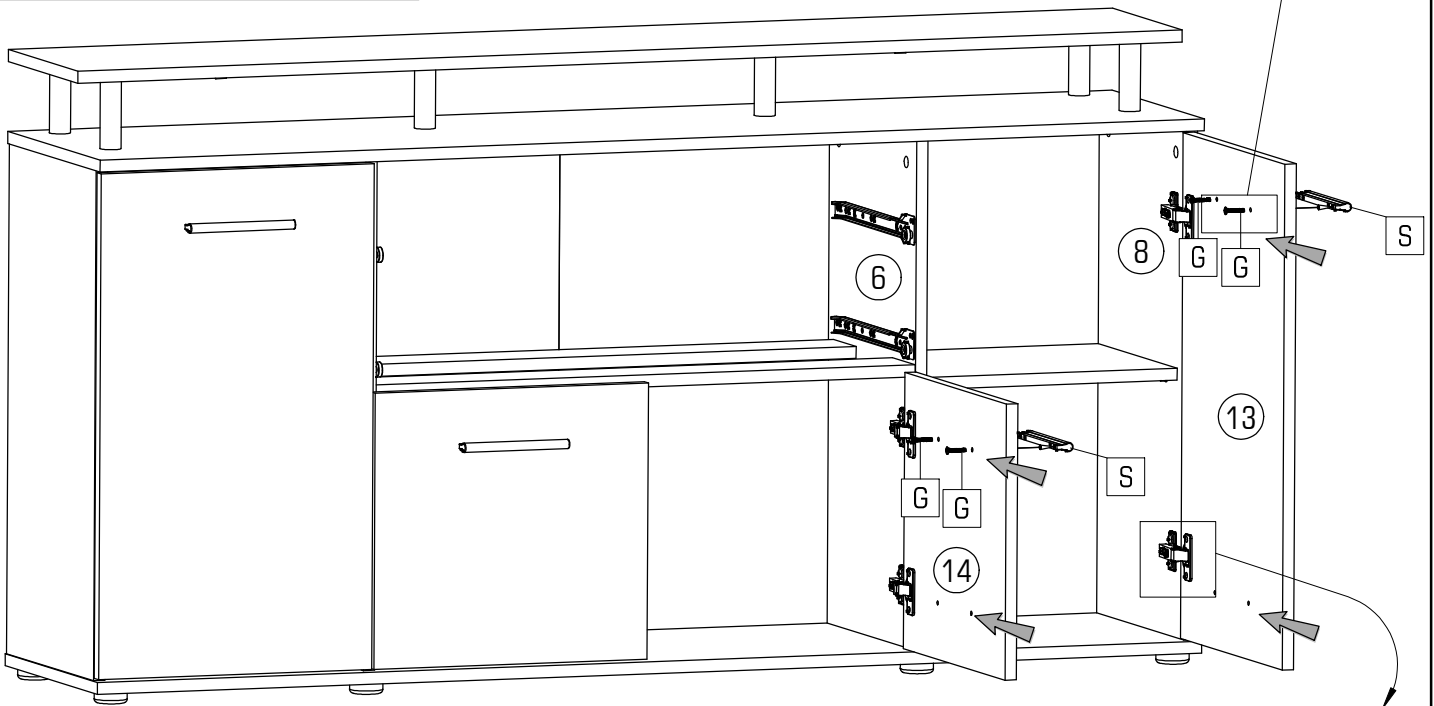
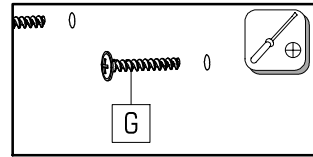
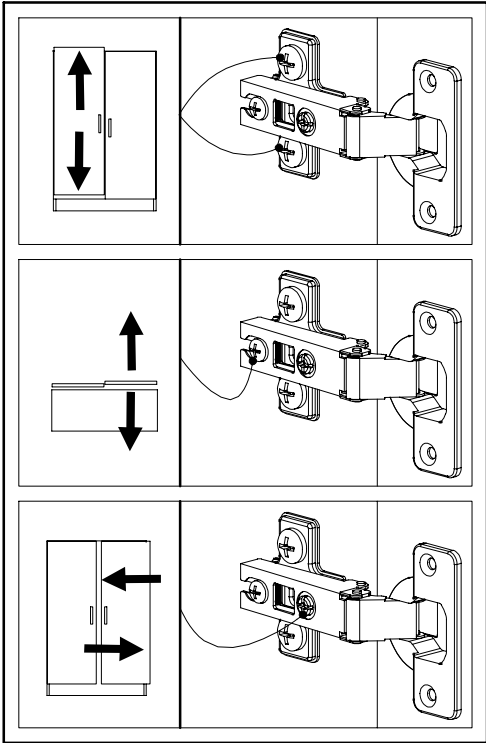
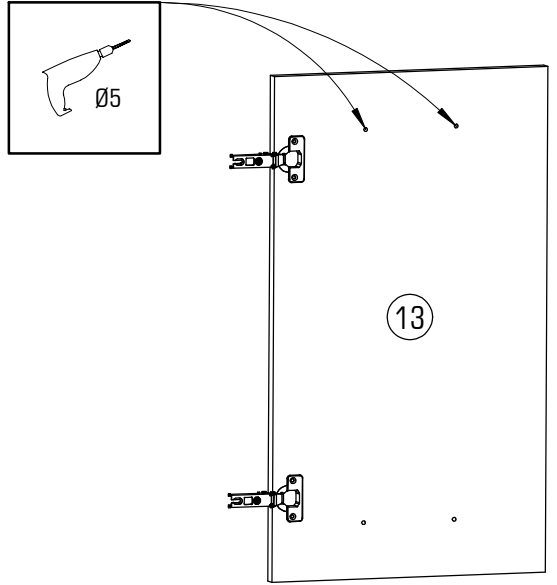
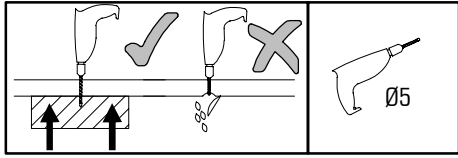
	
Ø4x25	L=150
G 4x	S 2x

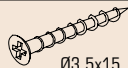

	$\varnothing 4 \times 25$		L=150
G	4x	S	2x



					
Ø3,5x15	Ø3,5x16	Ø7x50		L=300mm	
D 12x	E 10x	F 8x	P2 8x	U2 2x	Y 4x

