

980339

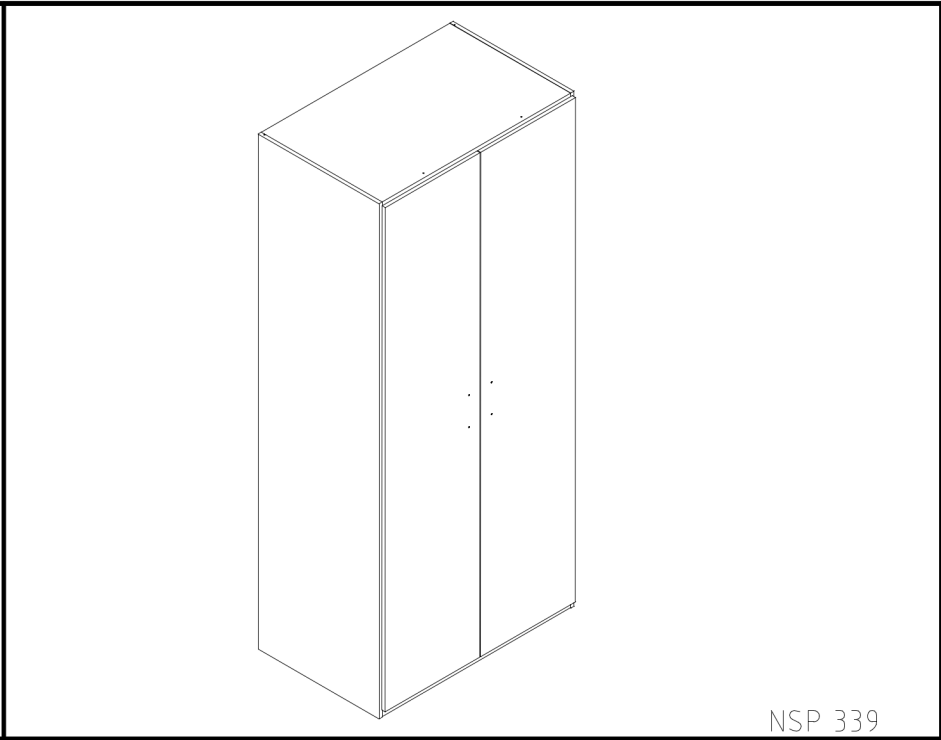

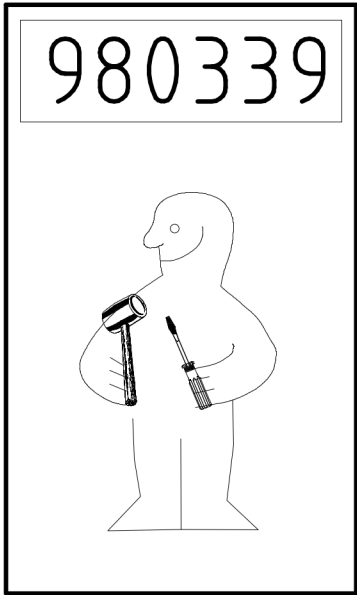

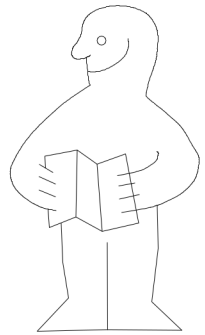
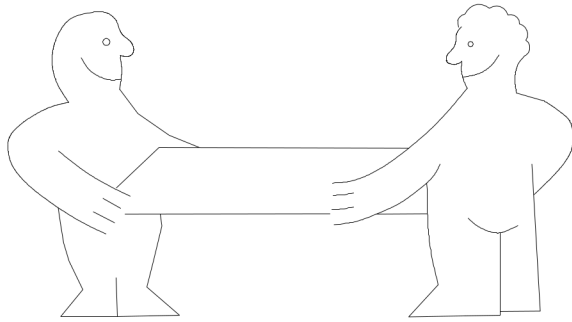
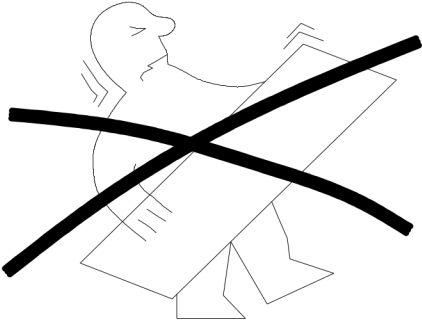

NSP 339

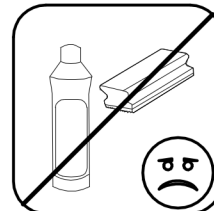
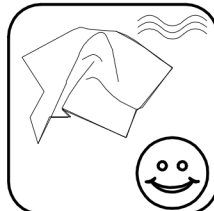
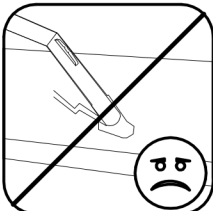
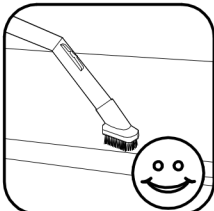
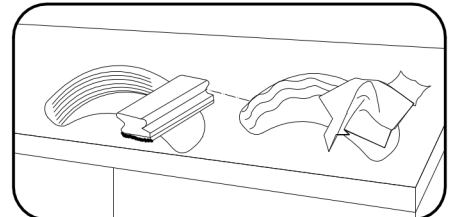
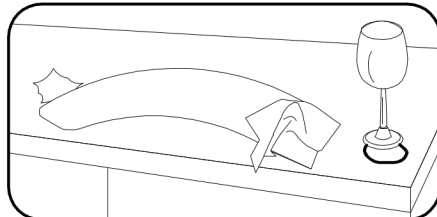
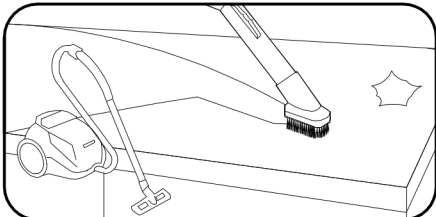
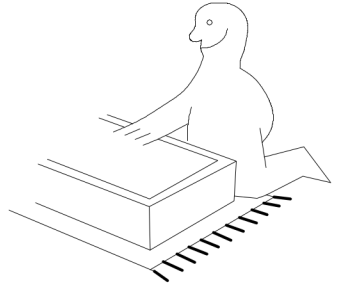
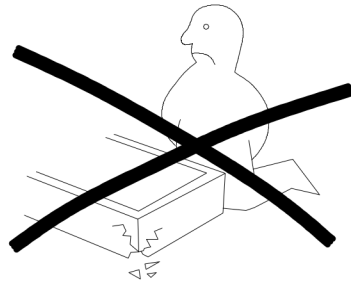
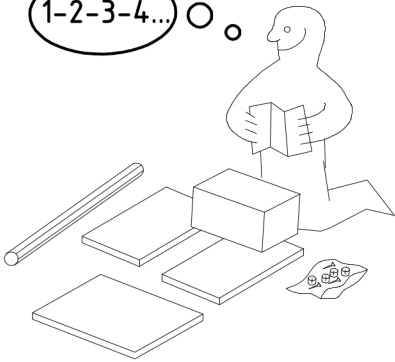

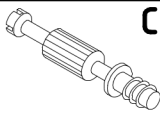
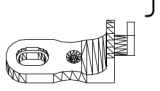
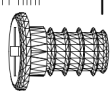



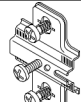

1-2-3-4... ○ ○

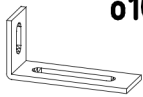

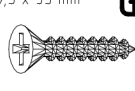
 111 102	<b>A</b> 8x
 111 103	<b>C</b> 8x
 111 174 M6 x 11 mm	<b>J1</b> 3x
 121 181	<b>T6</b> 2x

 111 610	<b>L7</b> 4x
 117 001	<b>K1</b> 2x
 112 268	<b>M</b> 6x
 112 267	<b>N</b> 6x

 111 052	<b>o10</b> 1x
 870mm 112 402	<b>K20</b> 1x
 3,5 x 15 mm 121 370	<b>G1</b> 4x
 3,5 x 35 mm 121 375	<b>G14</b> 4x

 4 X 13mm 121 122	<b>SP13</b> 1x
 4 X 15mm 121 120	<b>SP15</b> 1x
 4 X 27mm 122620	<b>SP27</b> 4x

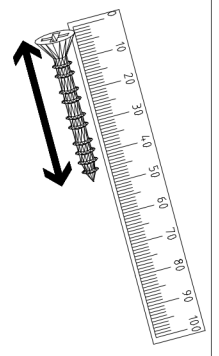
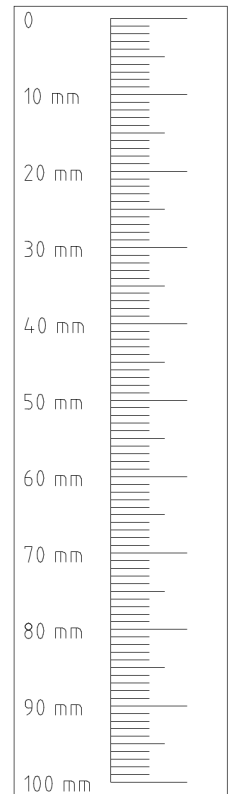
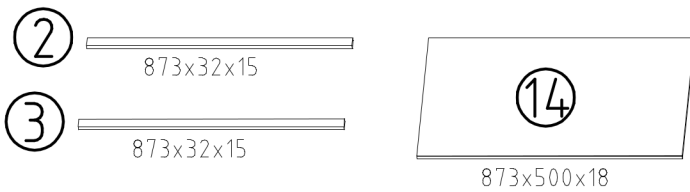
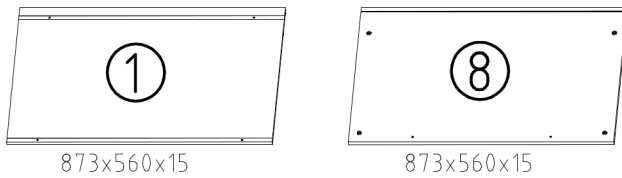
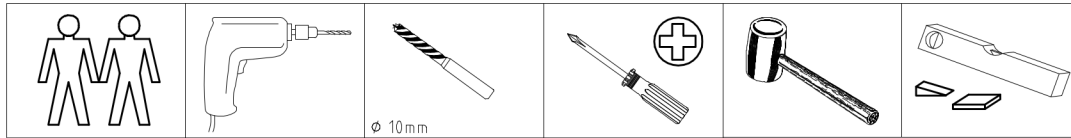

1

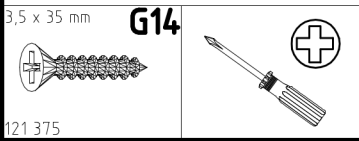
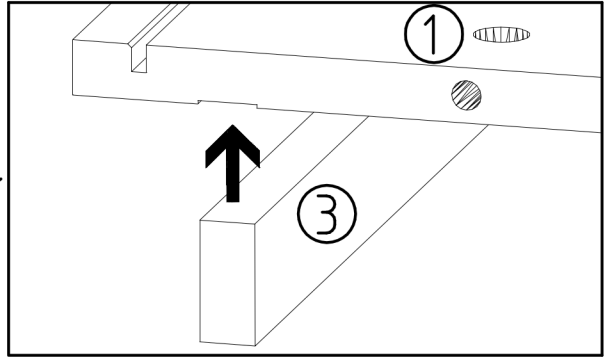
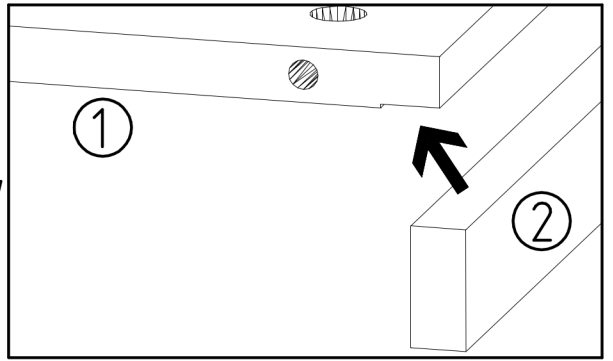
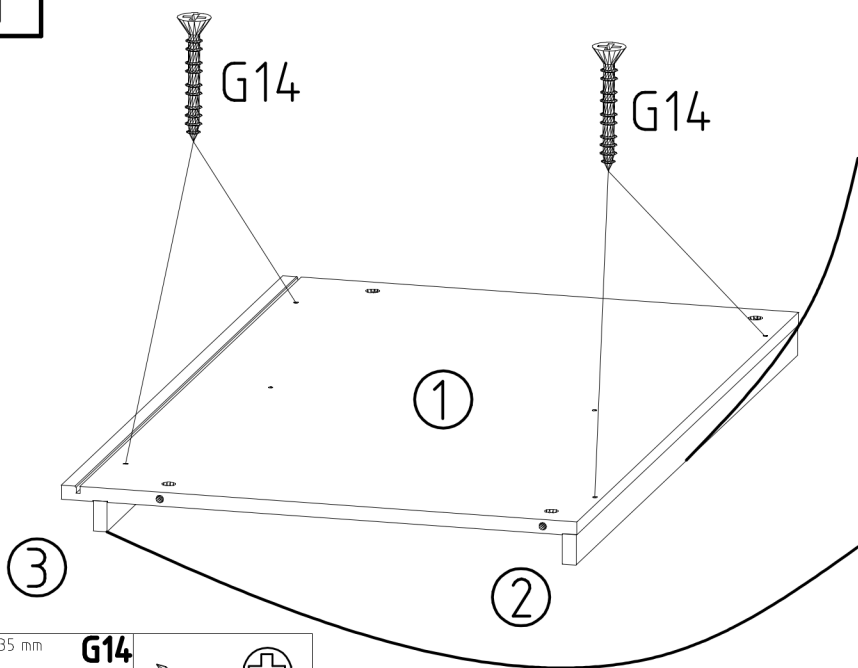

2

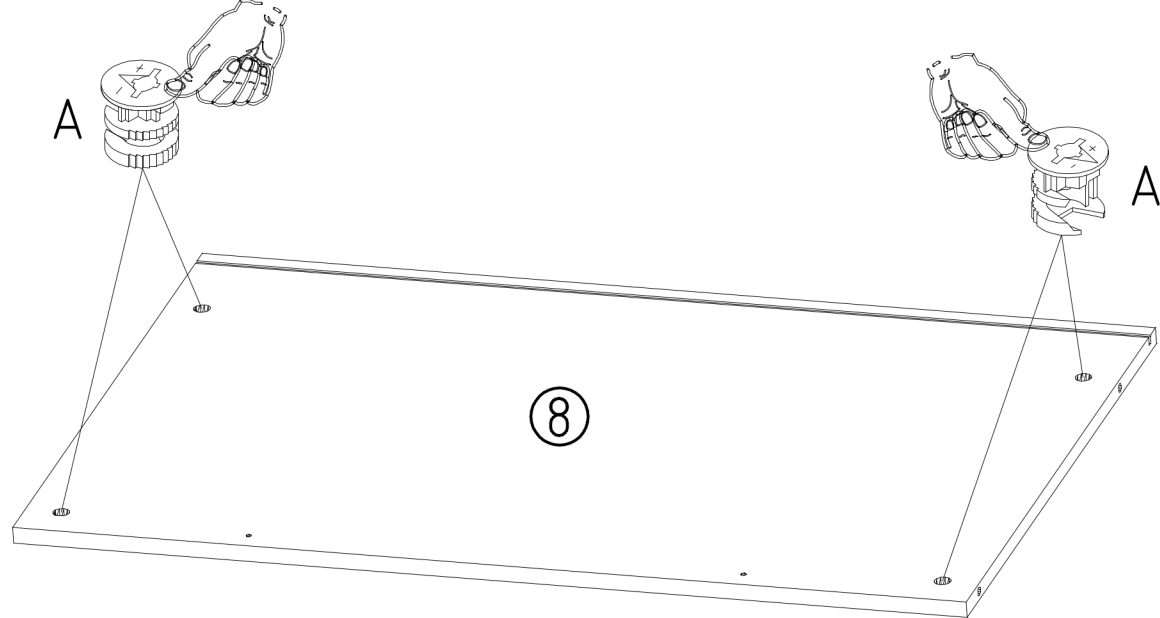
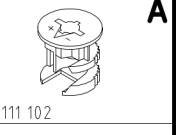
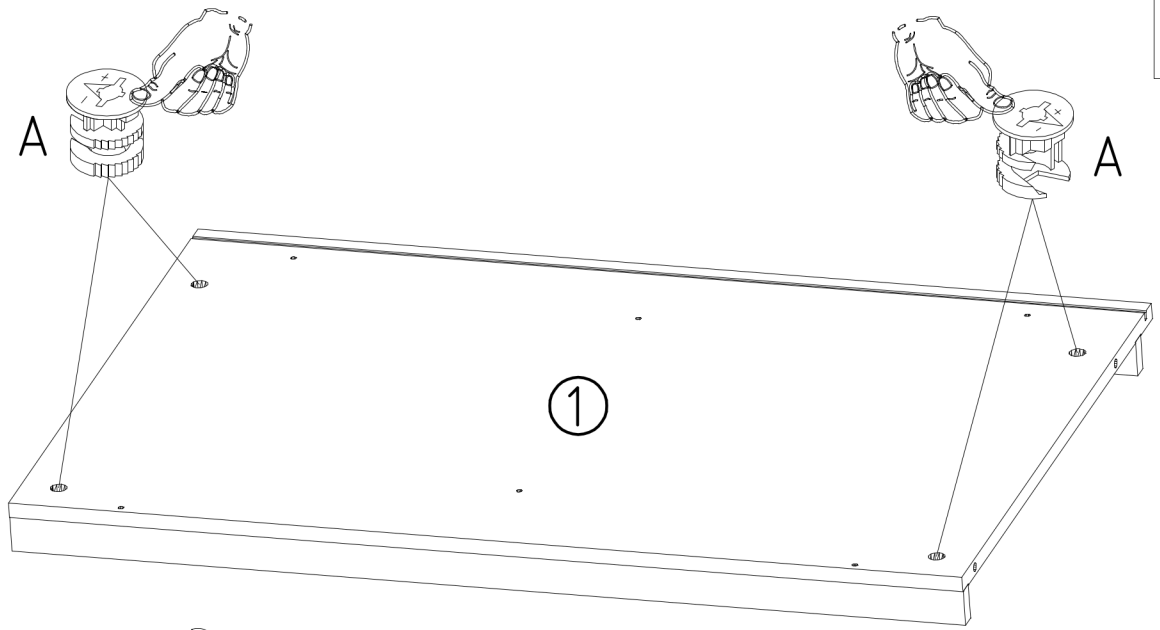

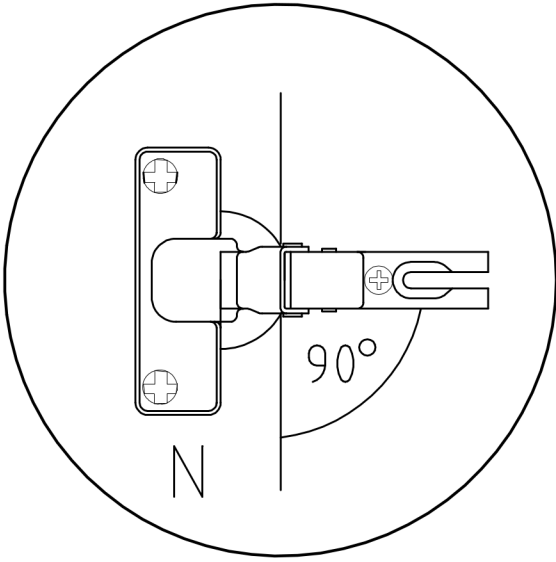
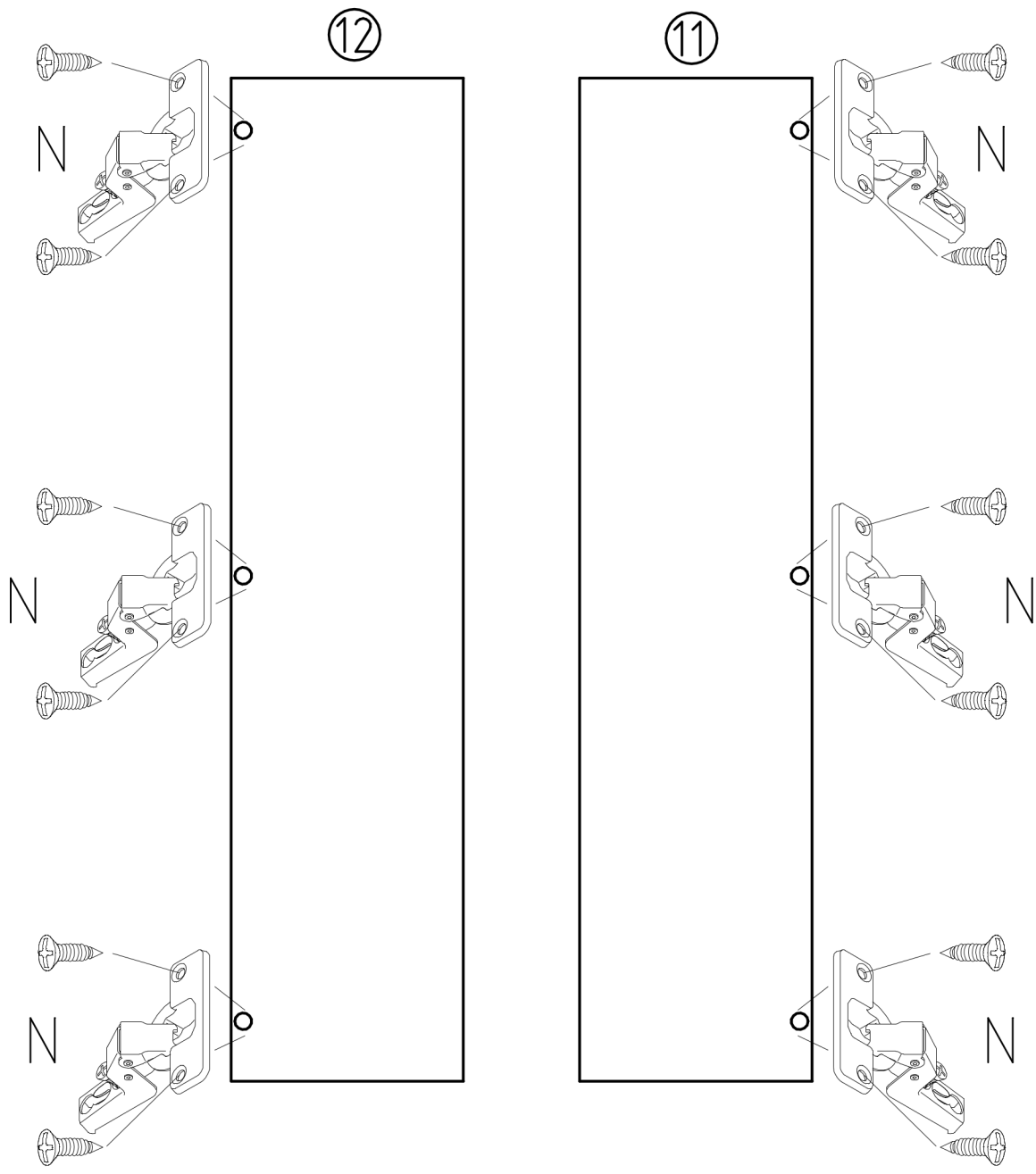
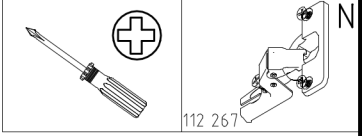

4

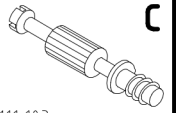
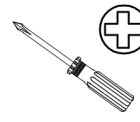

111 103

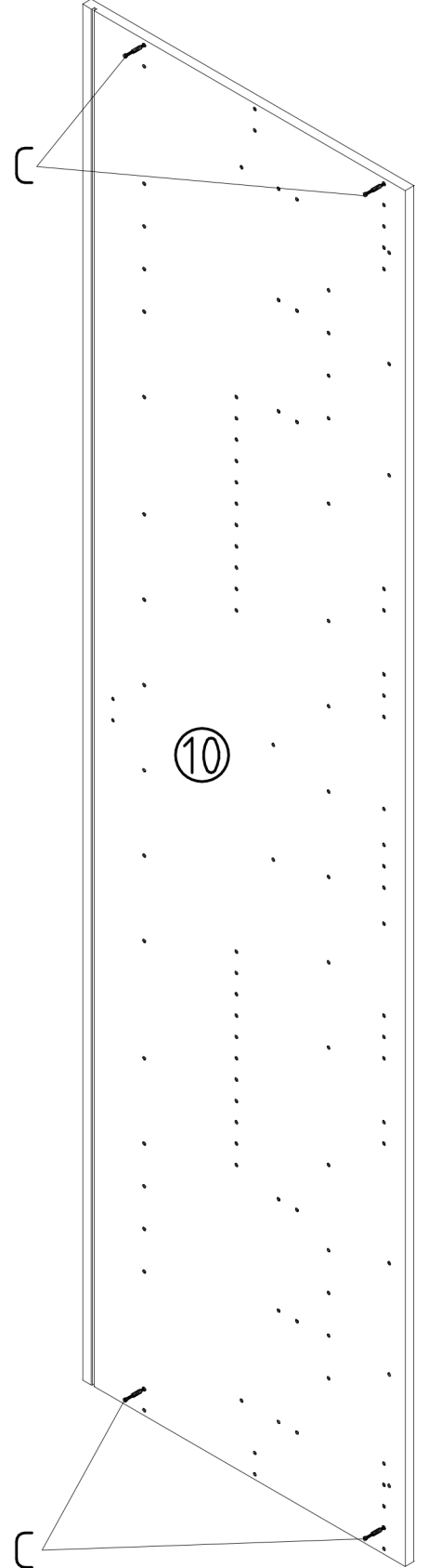
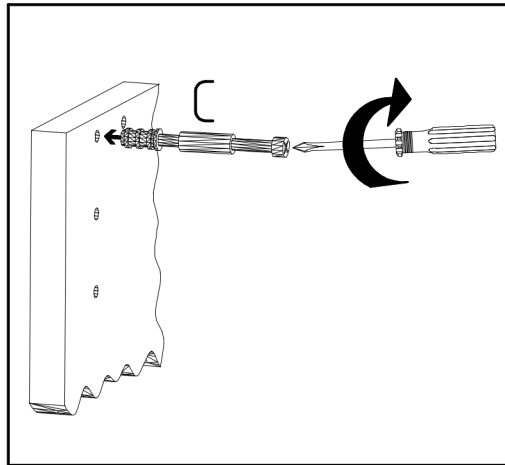
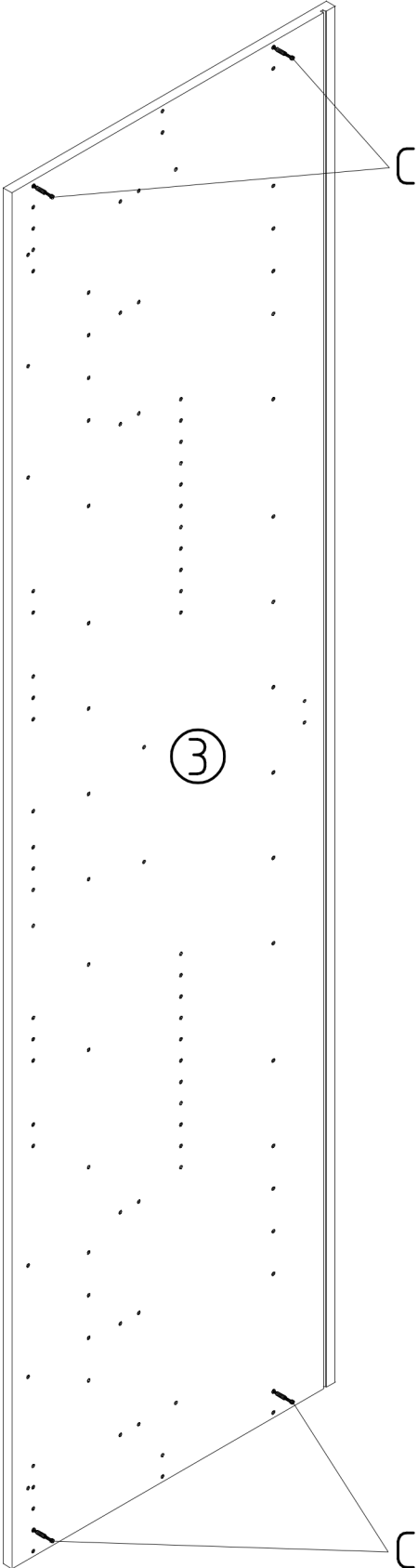

5

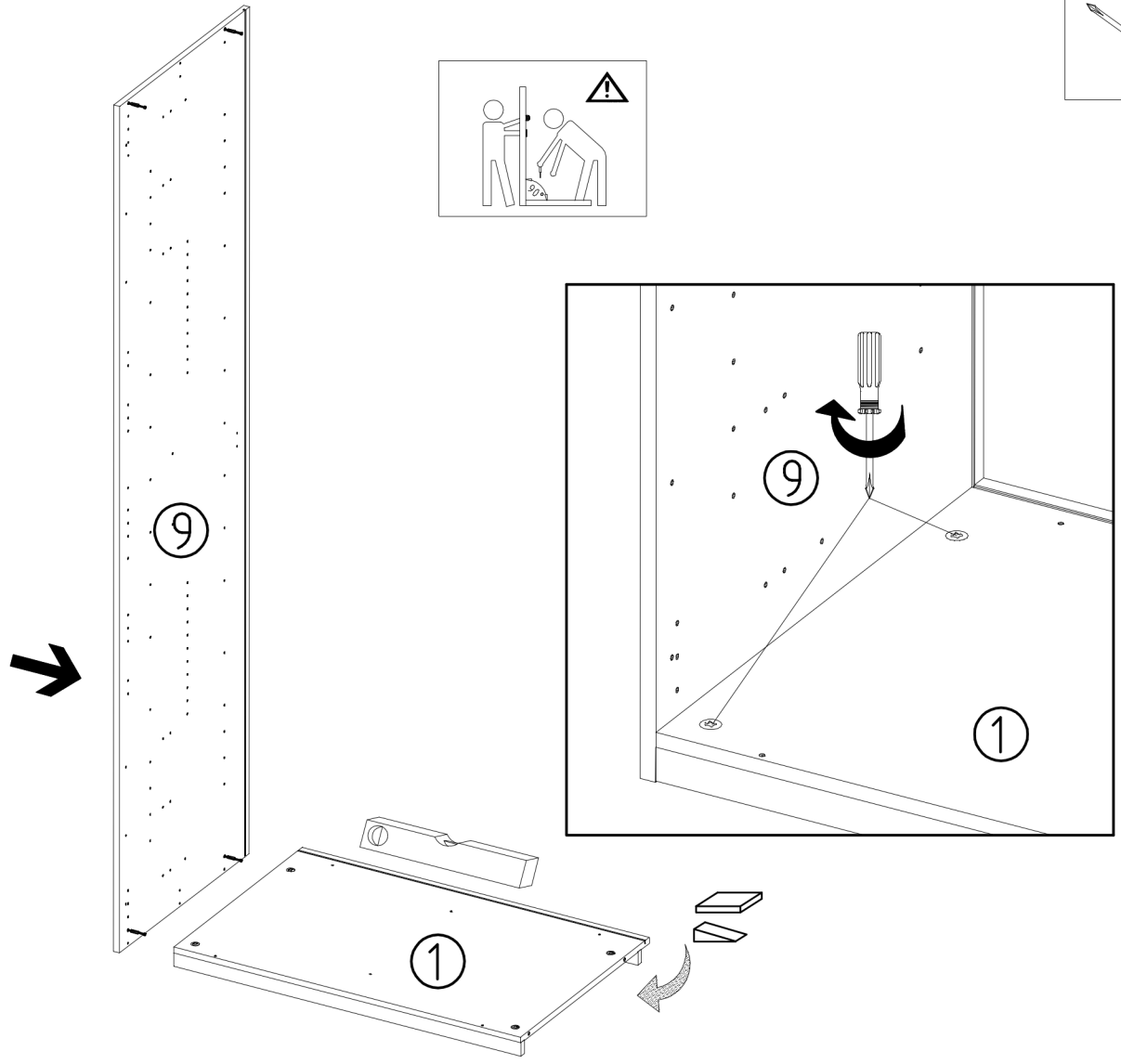
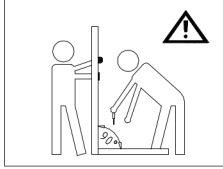
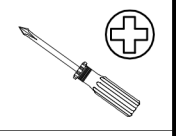

6

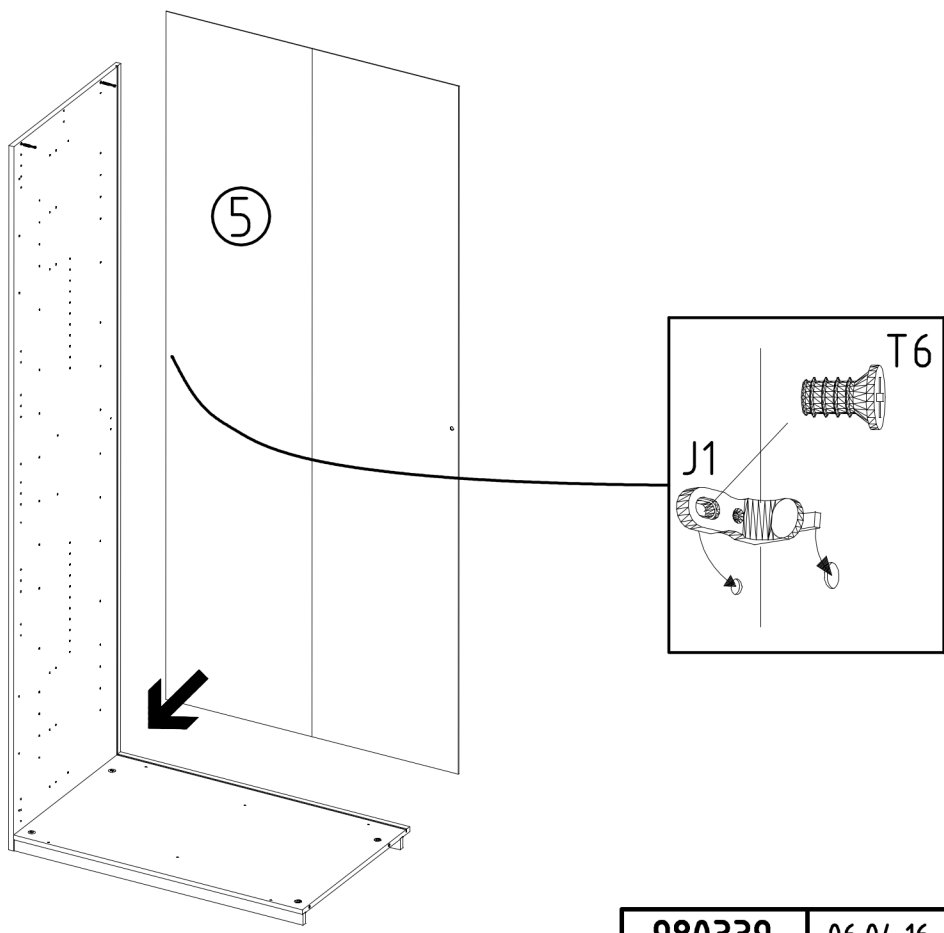
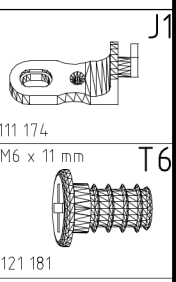
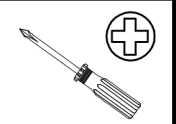

7

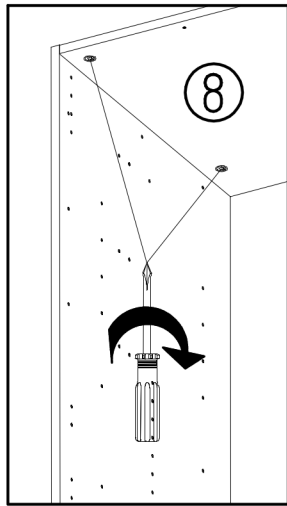
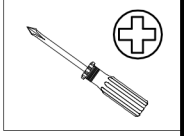
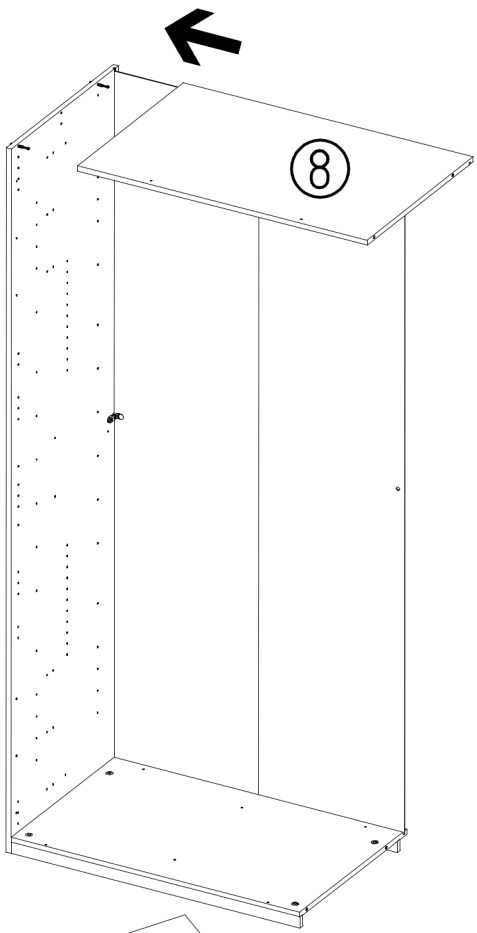

8 A

8 B

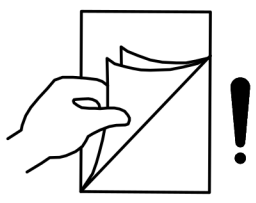
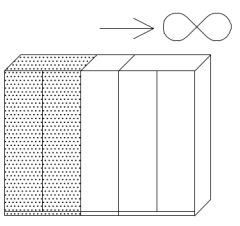

980350

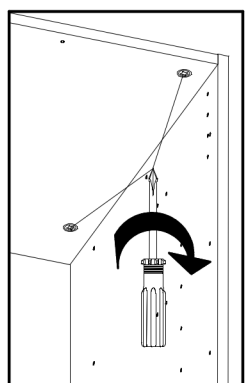
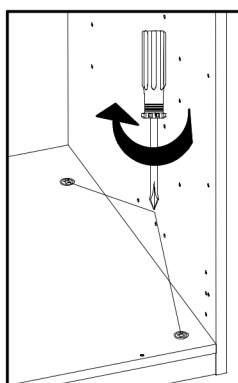
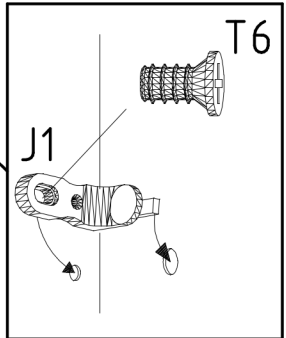
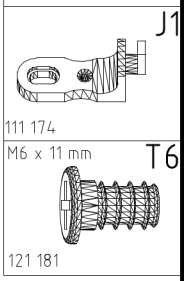
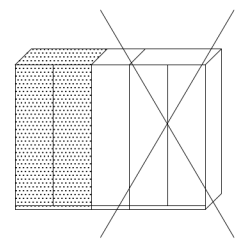
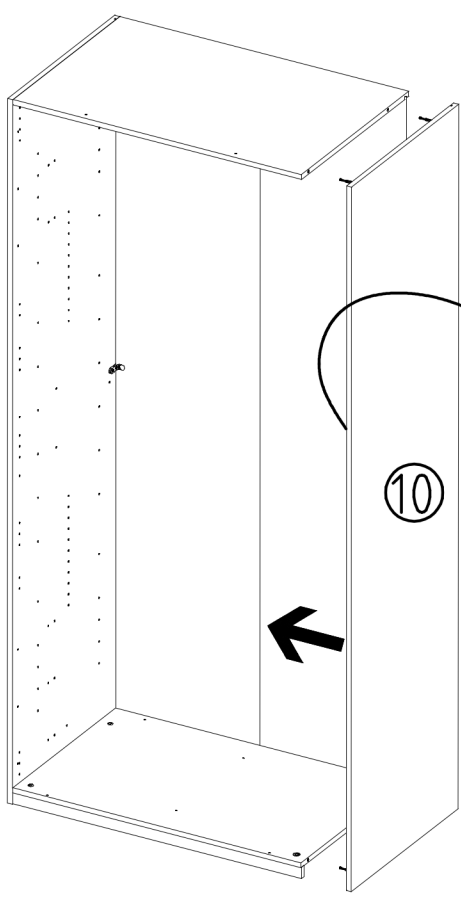

9

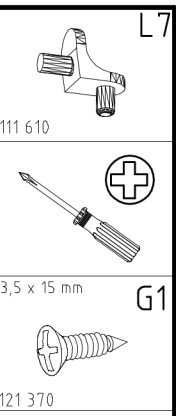
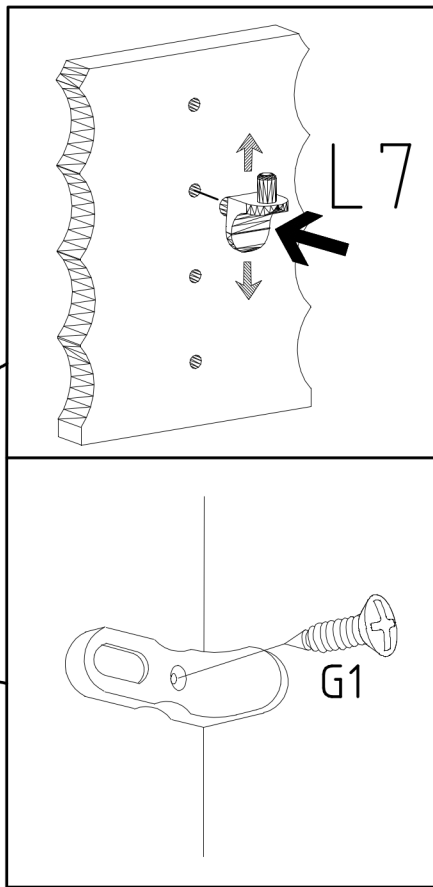
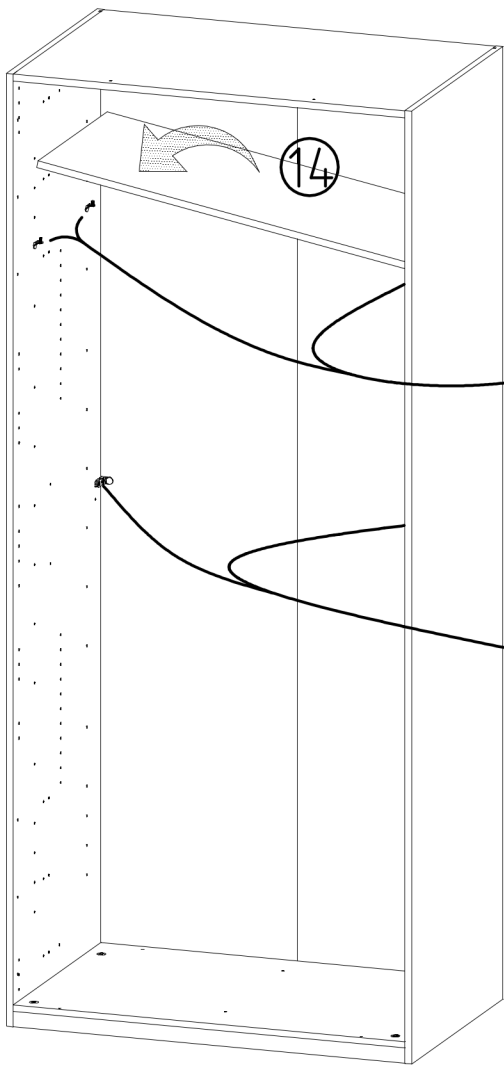

10

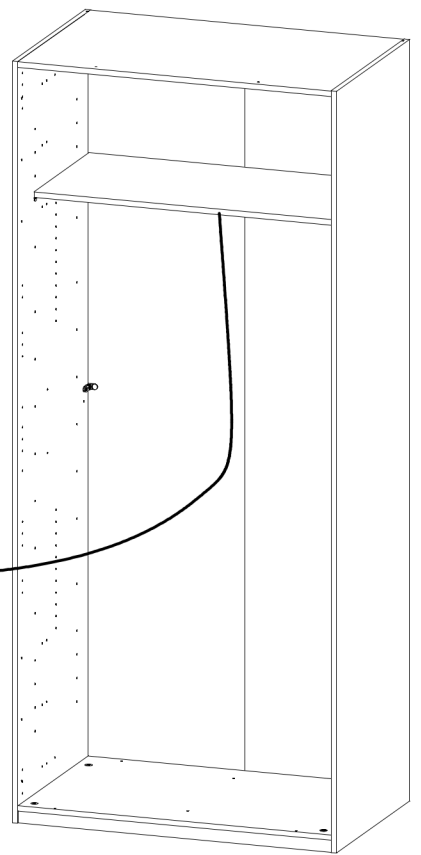
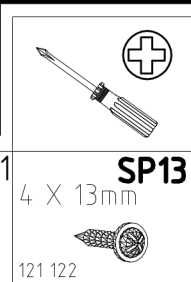
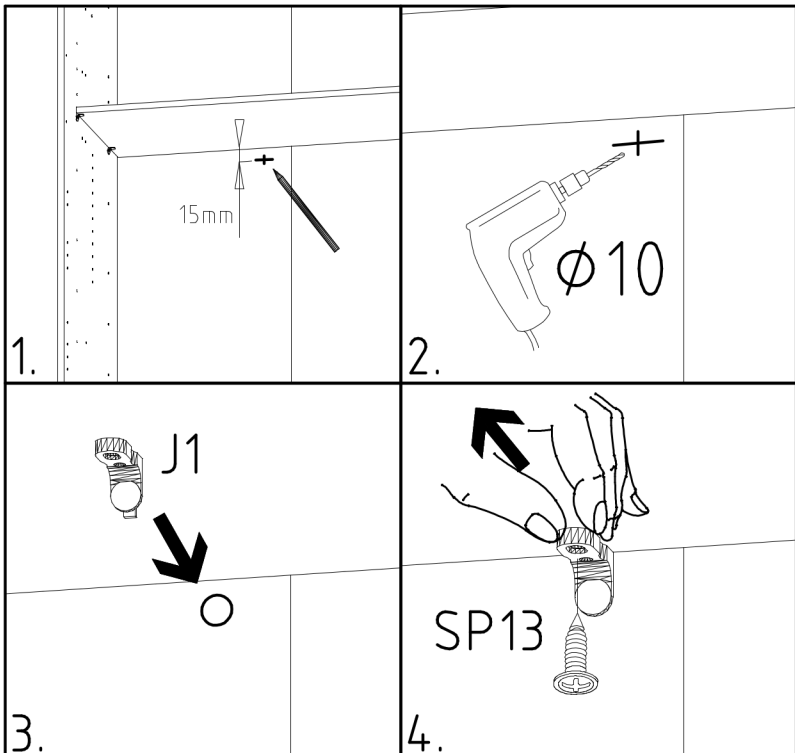
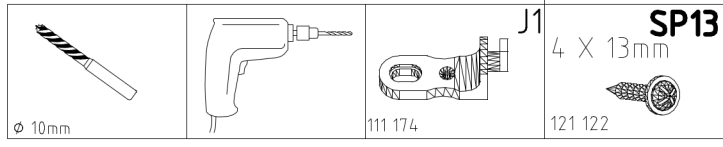



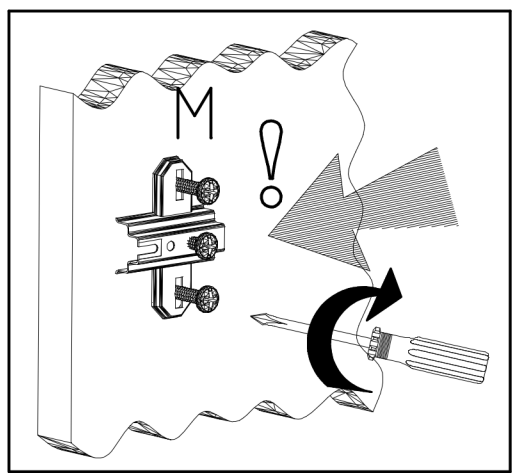
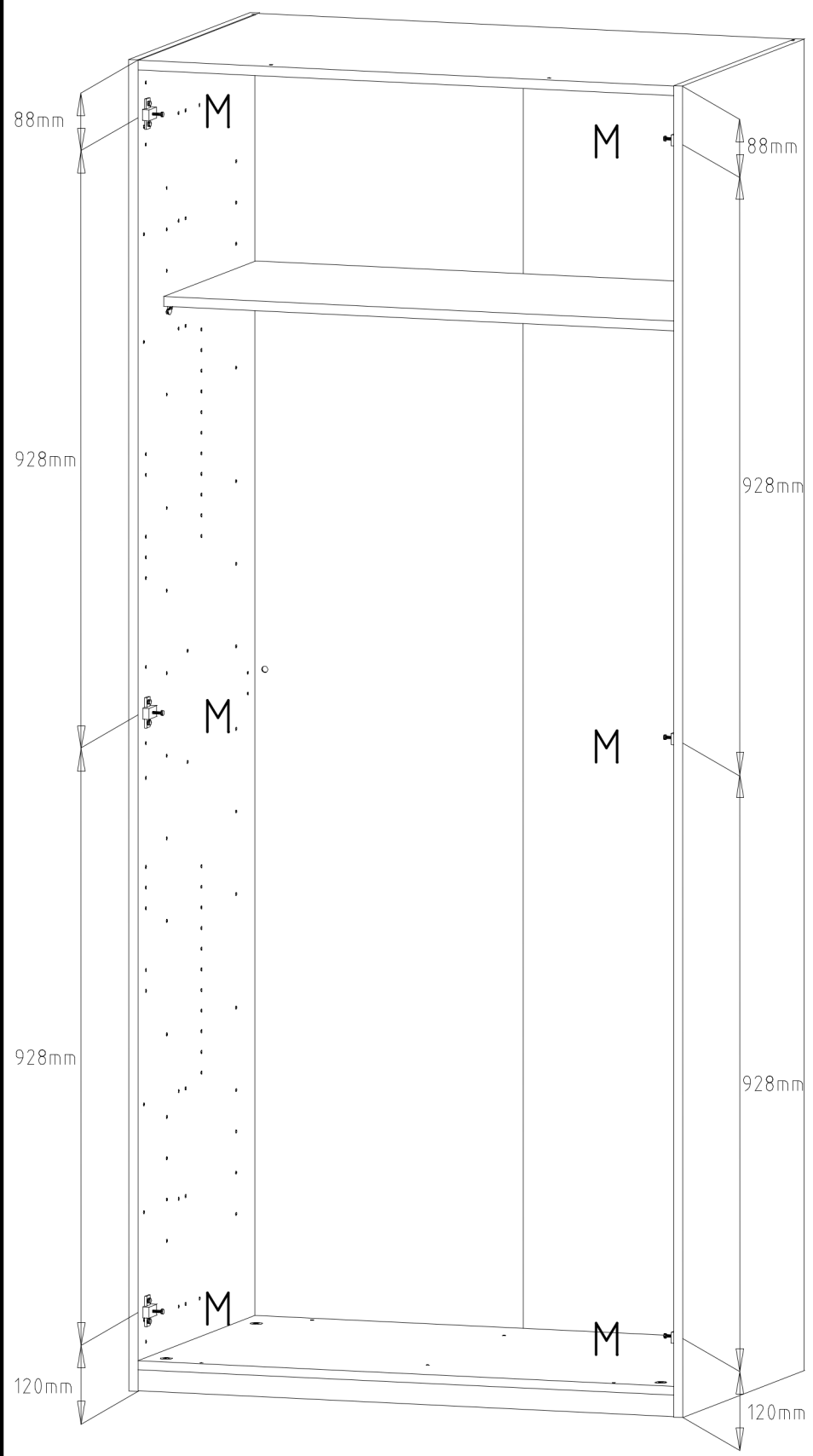
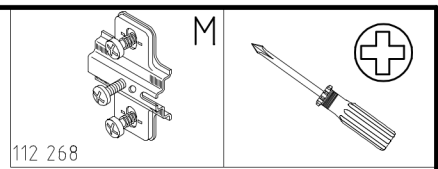

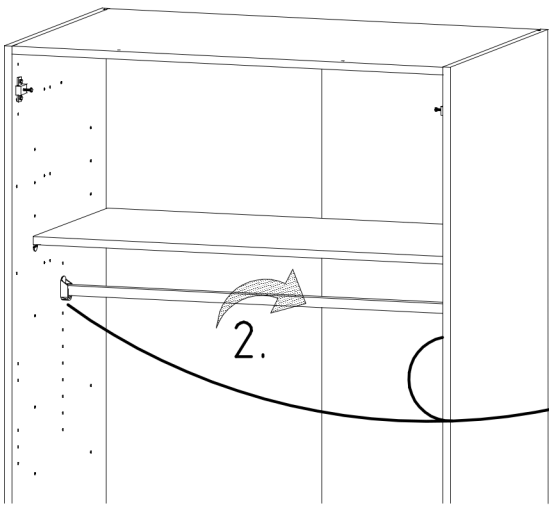

12

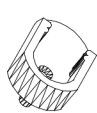
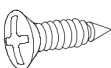

 K1 3,5 x 15 mm 117 001	 G1 121 370	 K20 870mm 112 402
--	---	---

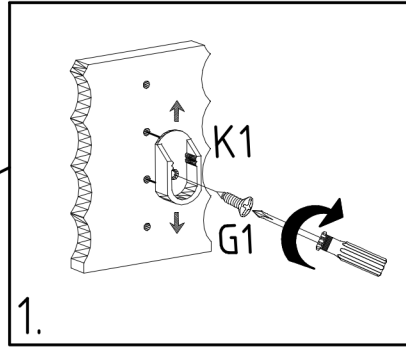

13

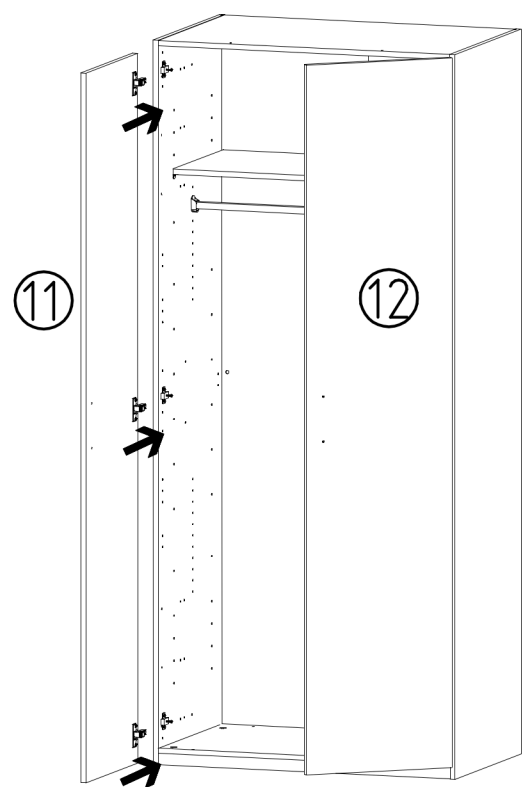
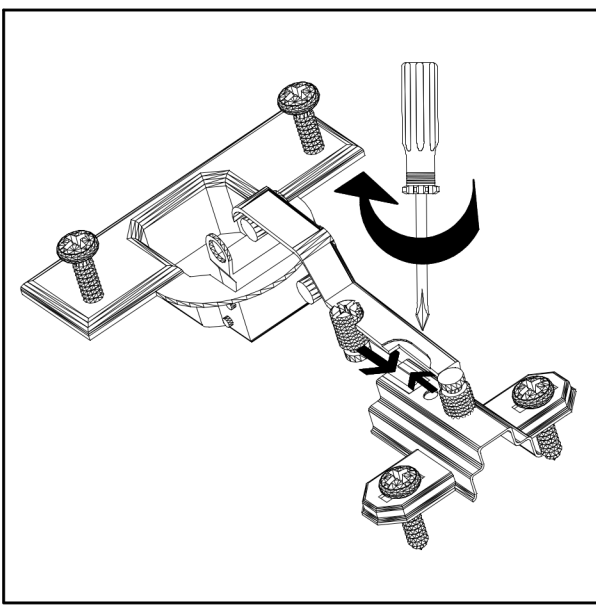
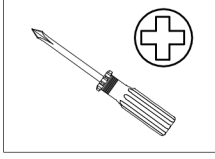

14

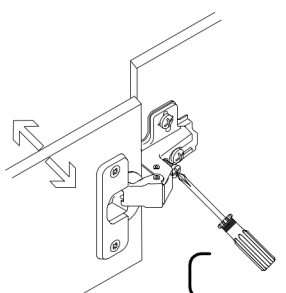
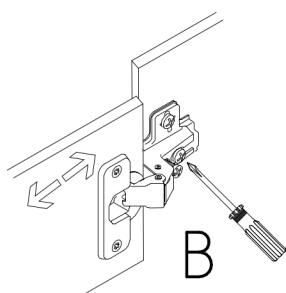
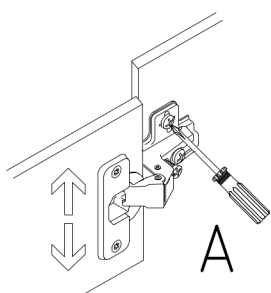
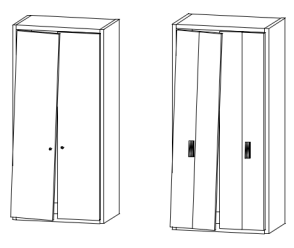
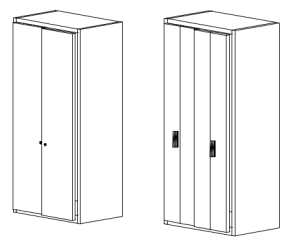
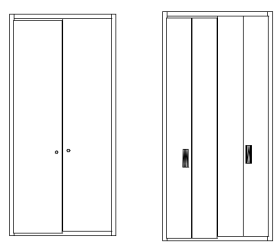
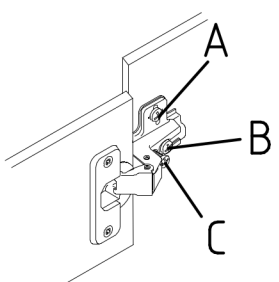
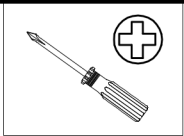

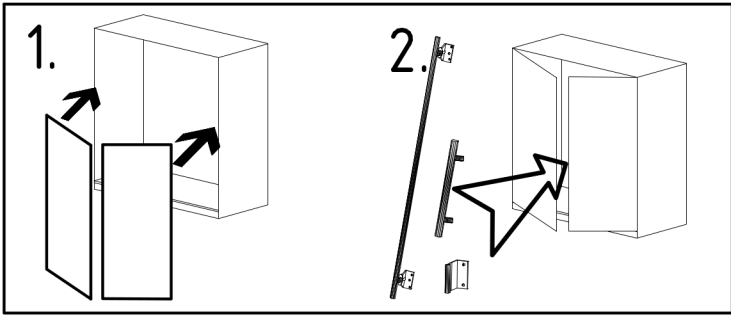

3,5 x 15 mm 121 370 	G1 4,0 x 12 mm 122 625 	
----------------------------	----------------------------------	--

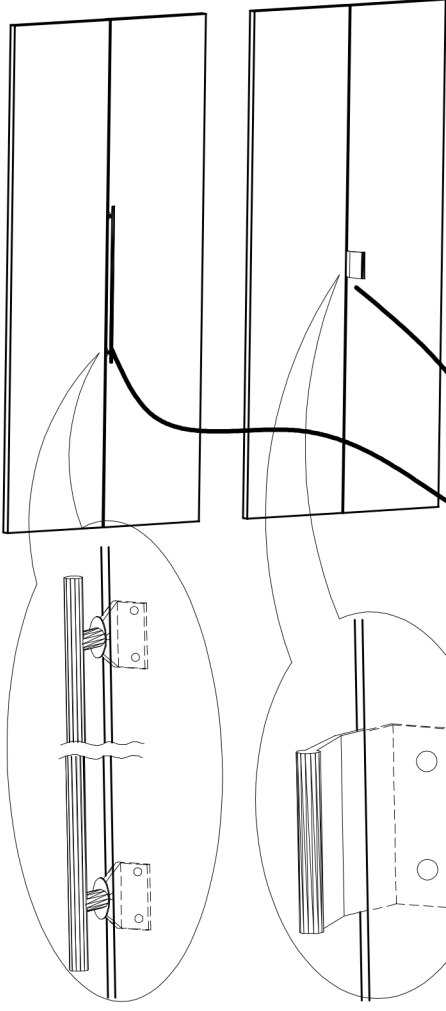

1x

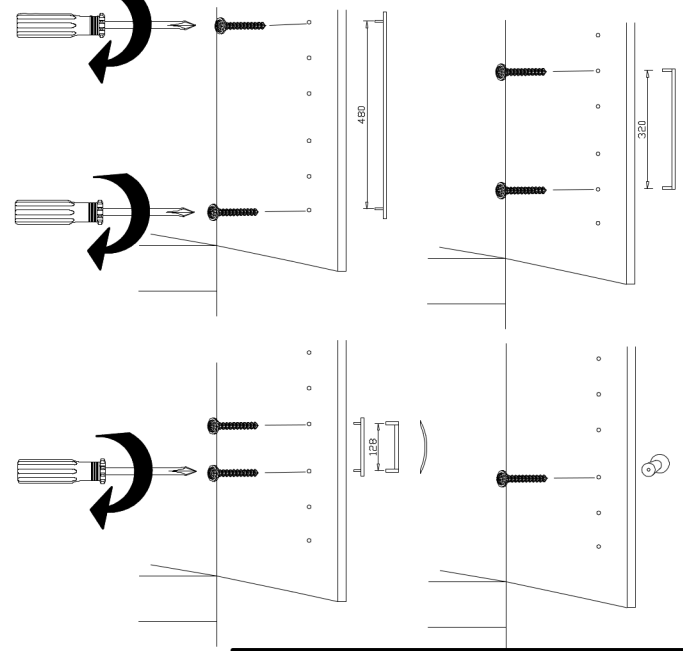
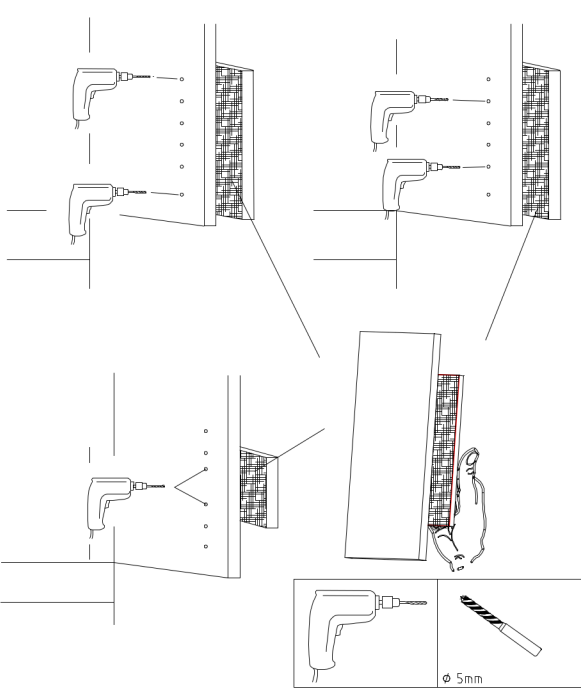
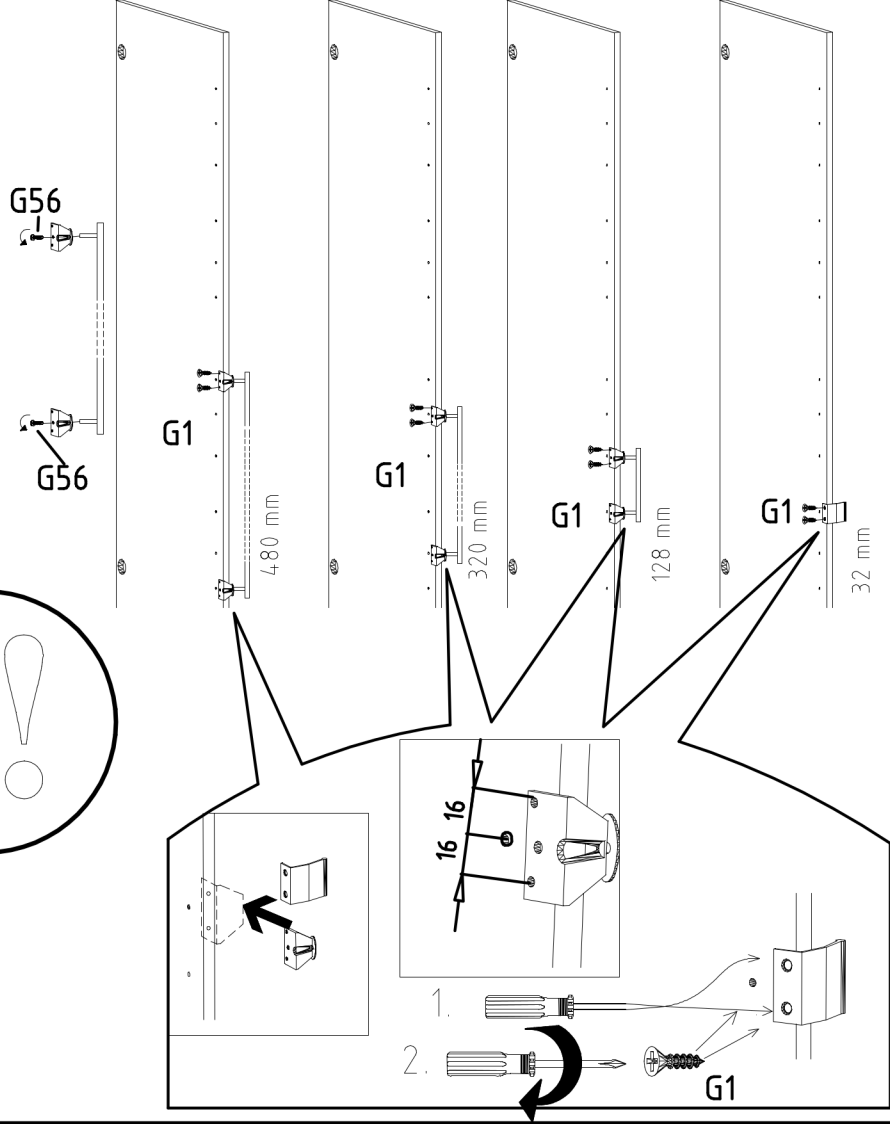

<b>SP27</b> 4 X 27mm 122620 4,0x22 G49 
122 609 

