

980246

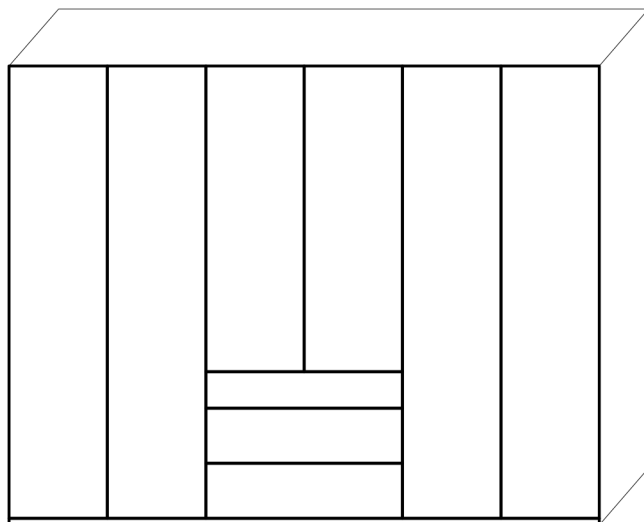

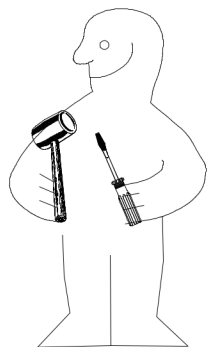

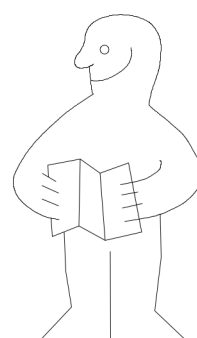

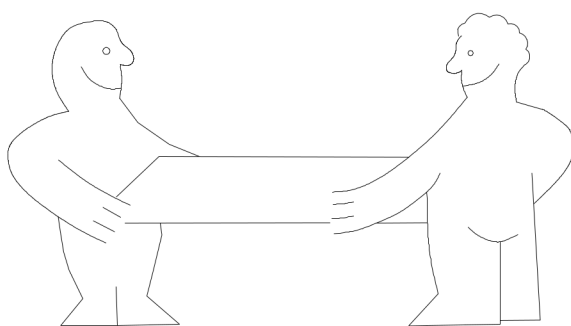
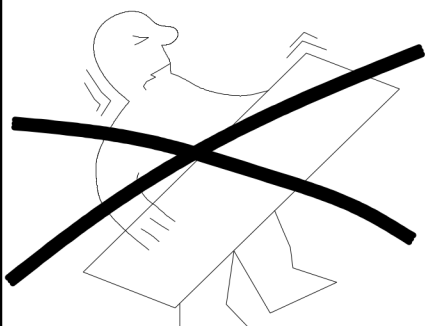

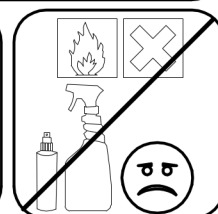
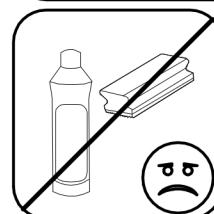
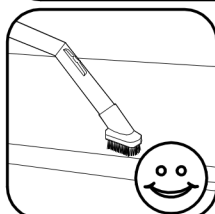
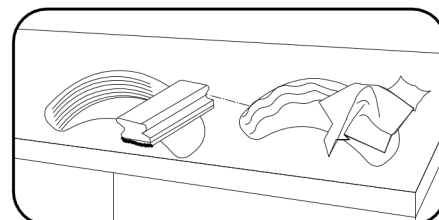
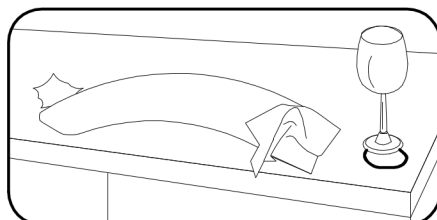
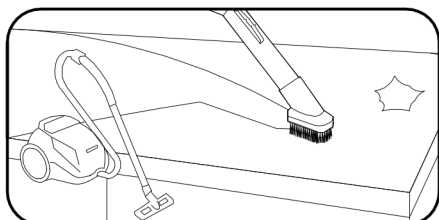
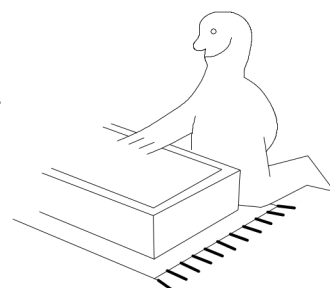
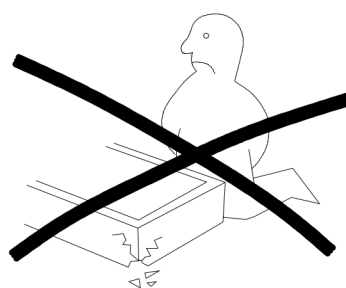
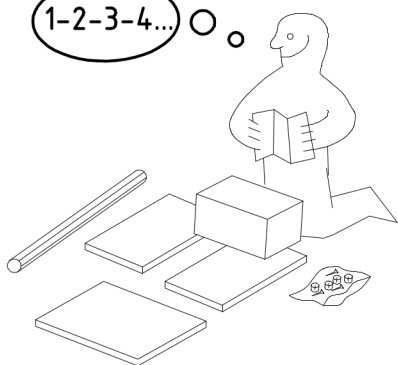
SHS 270

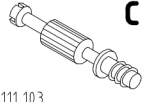
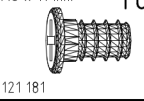
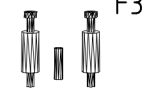

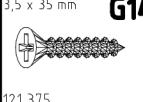

1-2-3-4... ○ ○



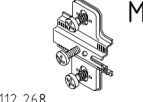
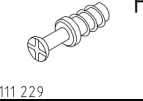
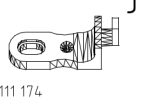

 111 103 M6 x 11 mm	C 12x
 121 181	T6 12x
 111 229	F3 4x
 111 102	A 20x

 121 375 3,5 x 35 mm	G14 12x
 117 001 3,5 x 15 mm	K1 4x
 121 370	G1 16x
 111 610	L7 16x

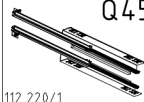
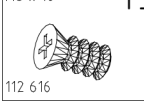
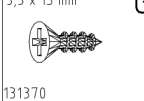
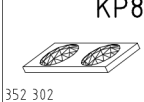
 112 268	M 22x
 111 229	F 4x
 111 174	J1 12x
 111 252	VB23 4x

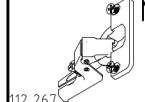
 112 220/1 M6 x 10	Q45 3x
 112 616 3,5 x 15 mm	T3 12x
 131370	G 12x
 352 302	KP8 6x

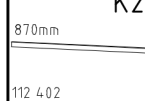
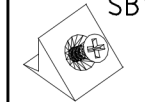
 112 267	N 22x
 xxx xxx	AW1 2x
 870mm	K20 2x
 112 402	SBV 18x

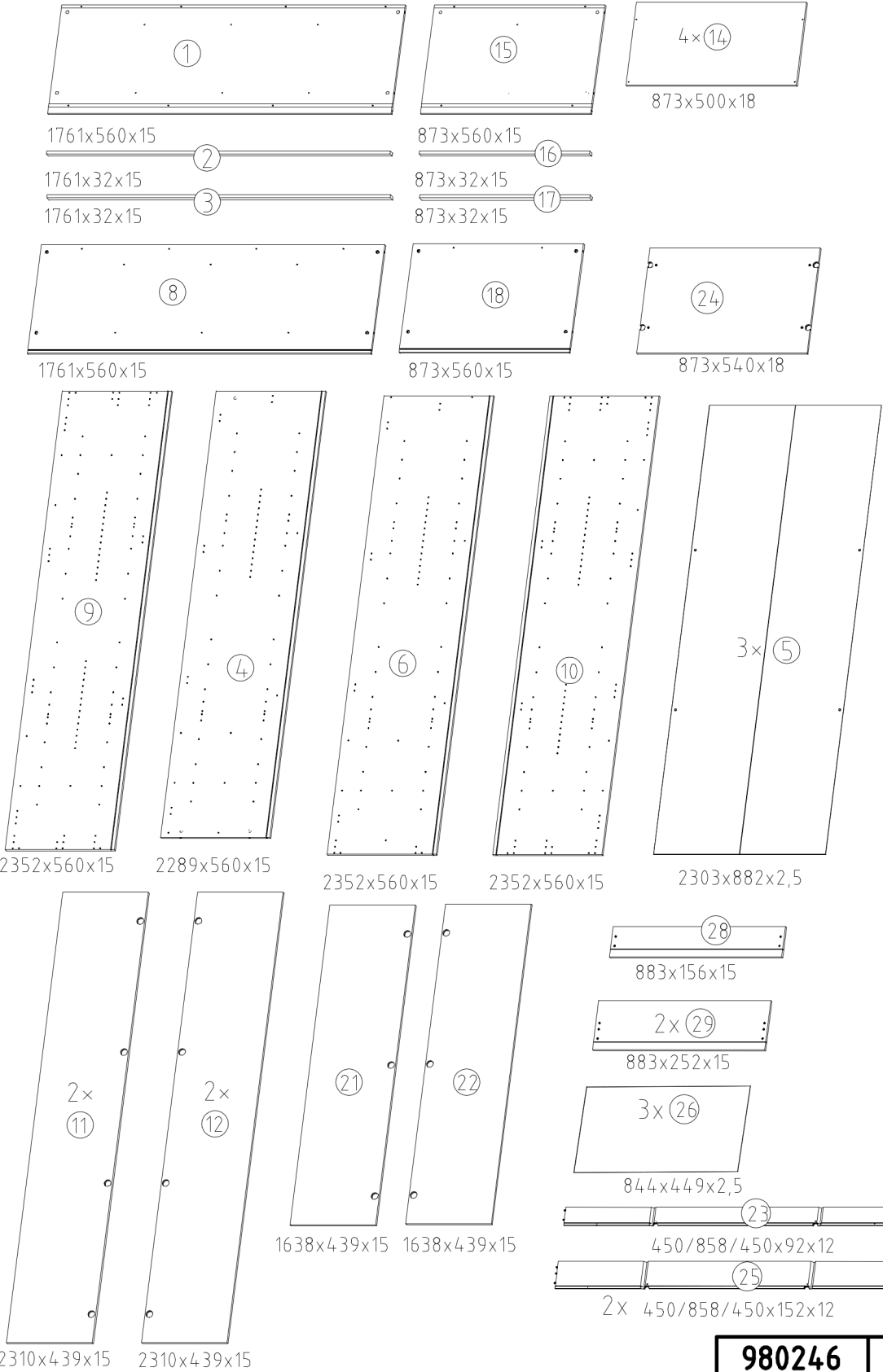

0
10 mm
20 mm
30 mm
40 mm
50 mm
60 mm
70 mm
80 mm
90 mm
100 mm

φ 5mm

1

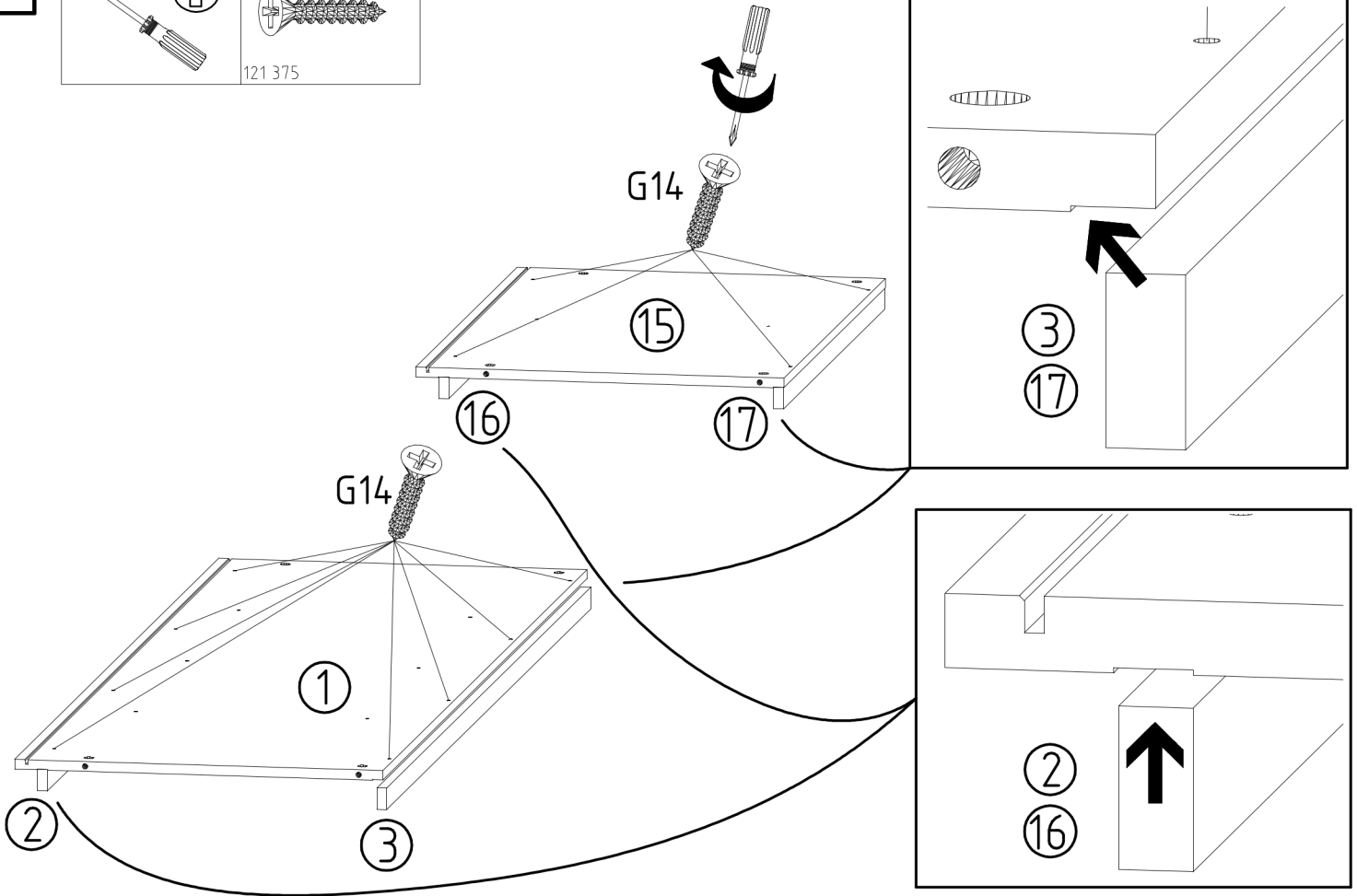
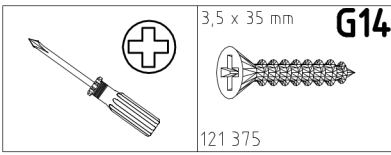



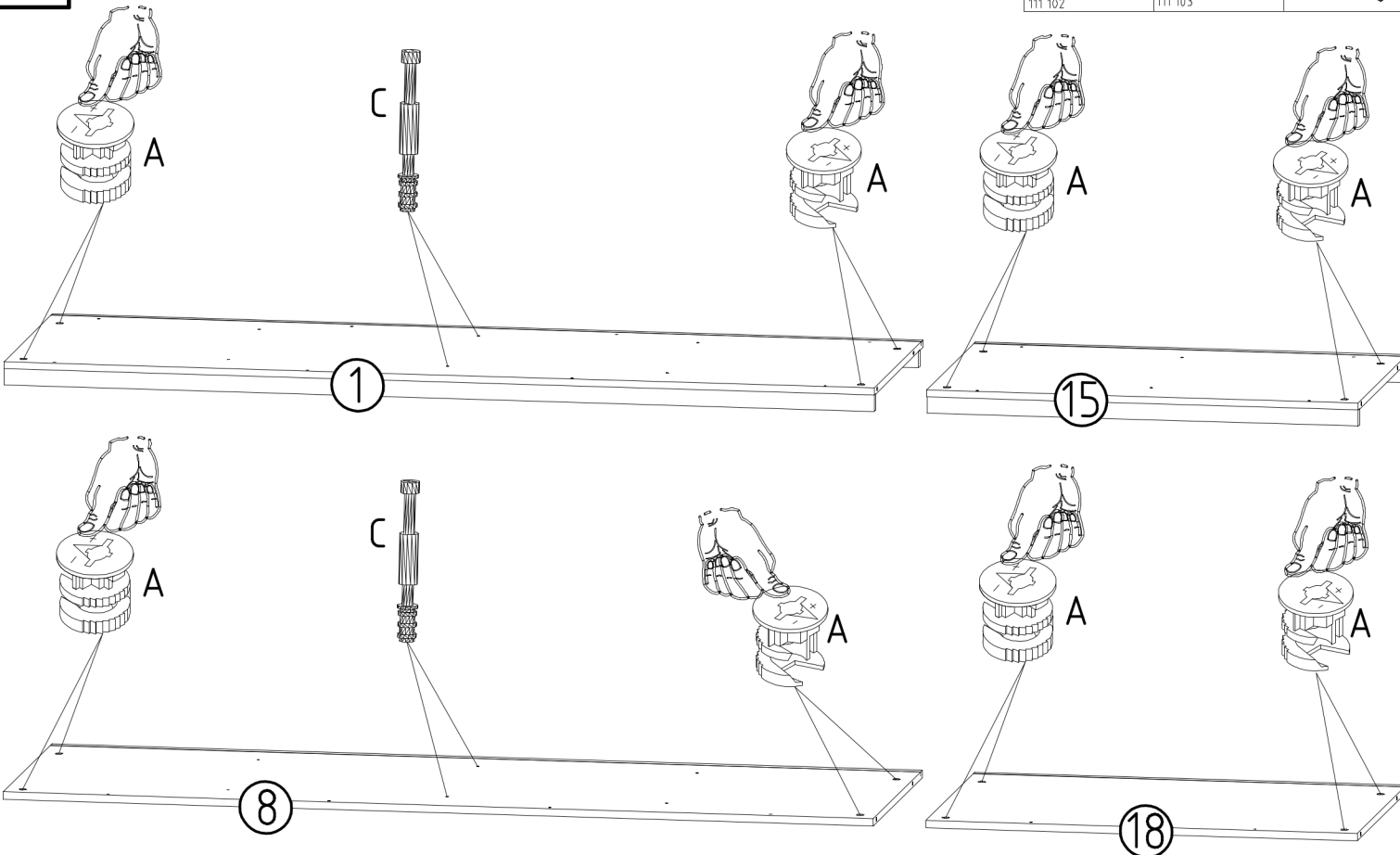
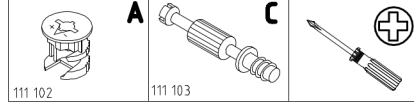



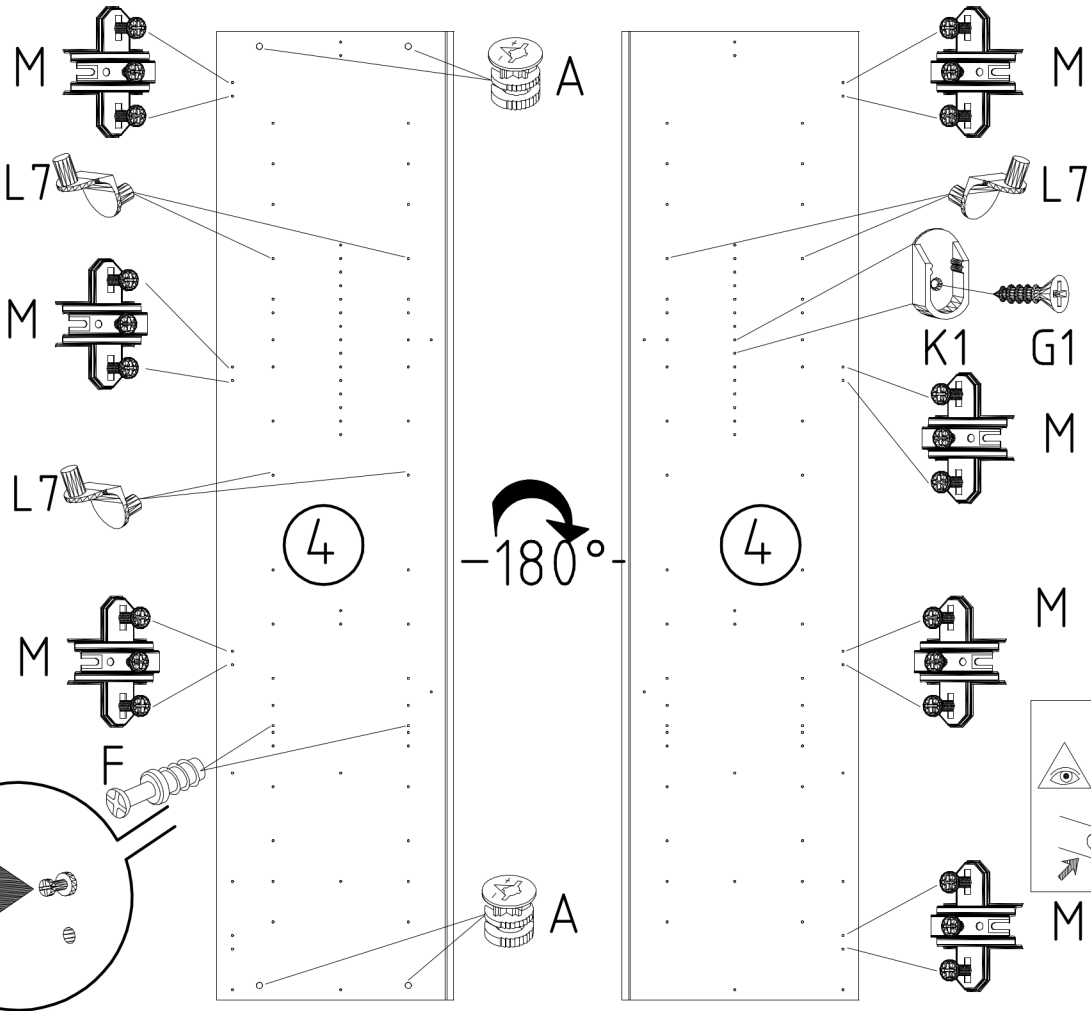

2



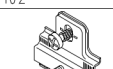



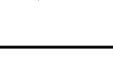
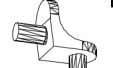

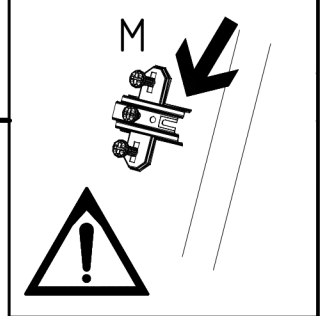
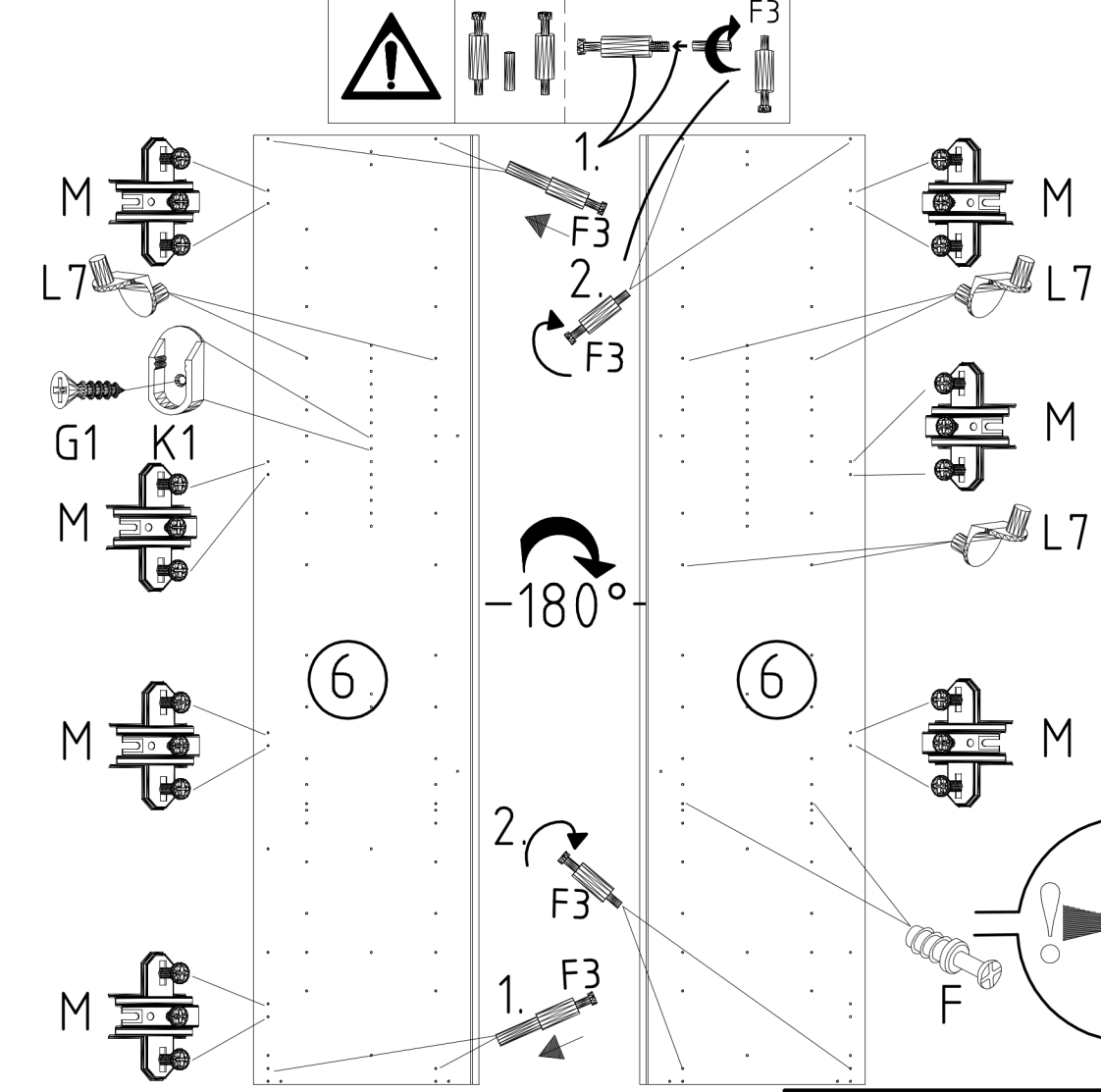

3

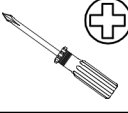

- L7 
- 111 610 
- K1 
- 117 001 3,5 x 15 mm 
- G1 
- 121 370 
- A 
- 111 102 
- M 
- 112 268 
- F 
- 111 229 

4

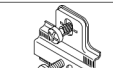
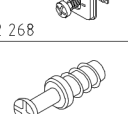

- L7 
- 111 610 
- K1 
- 117 001 3,5 x 15 mm 
- G1 
- 121 370 
- F3 
- M 
- 112 268 
- F
- 111 229

5

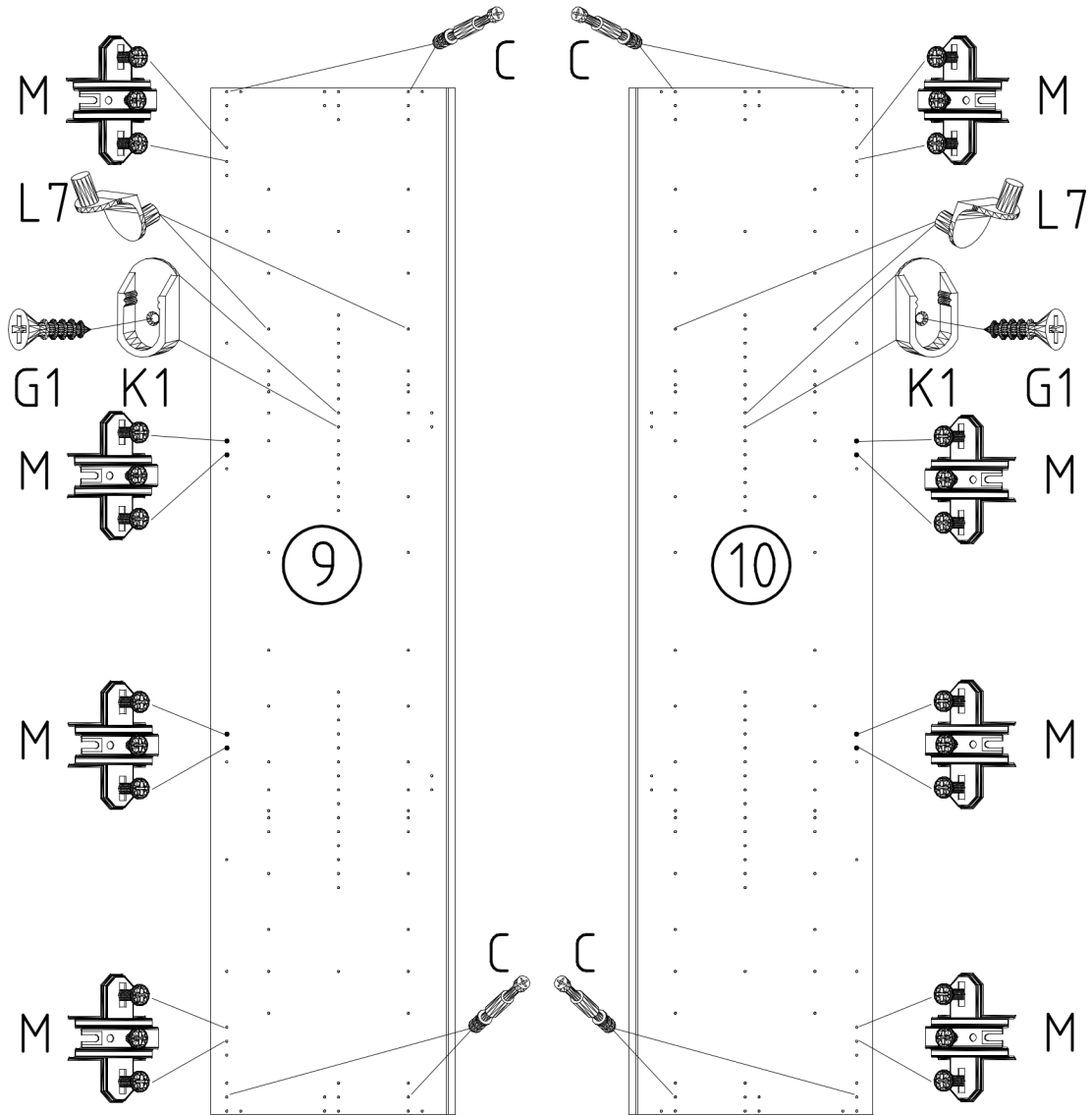

L7
111 610

G1
117 001
3,5 x 15 mm

C
121 370

M
111 103

M
112 268

6

N
112 267

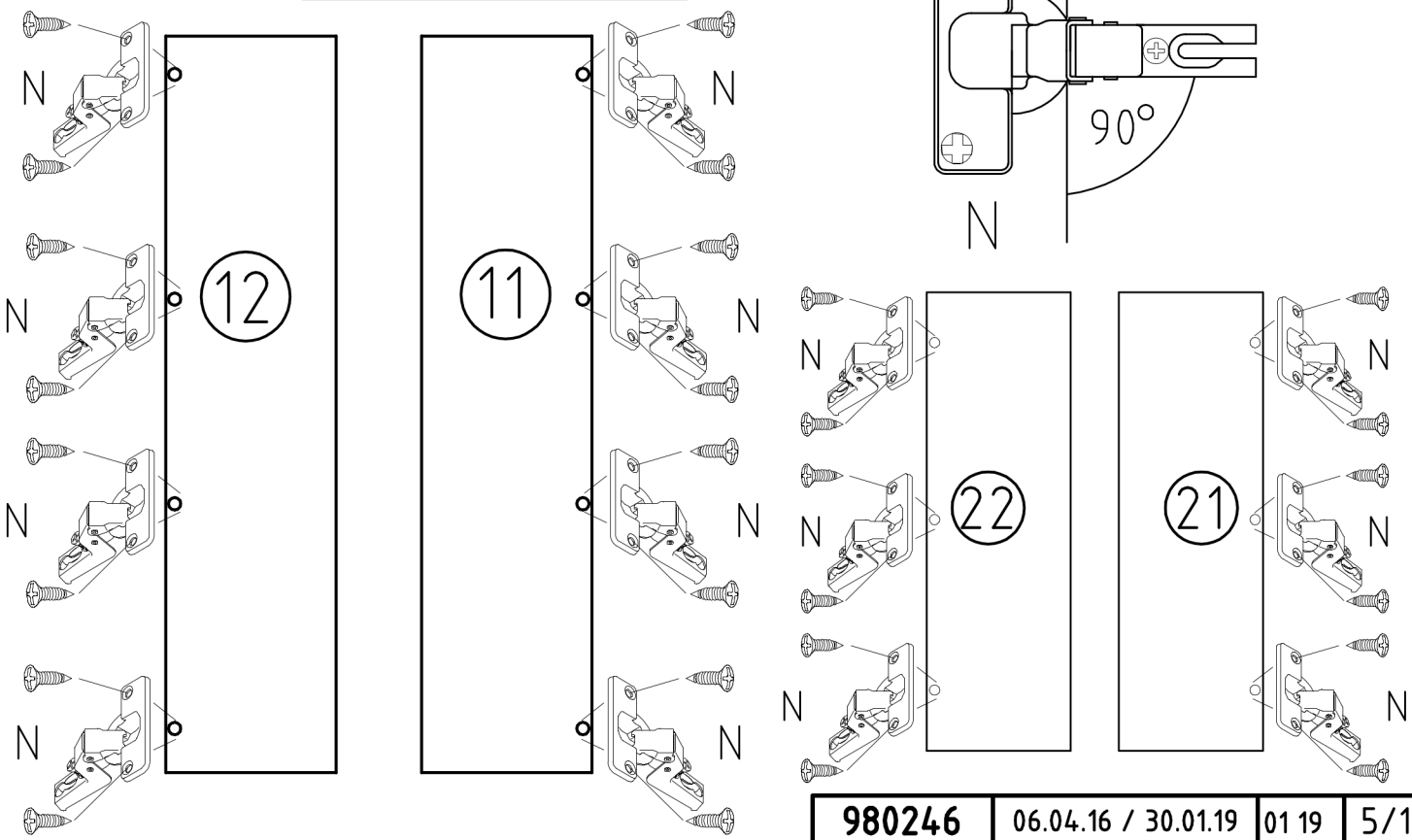

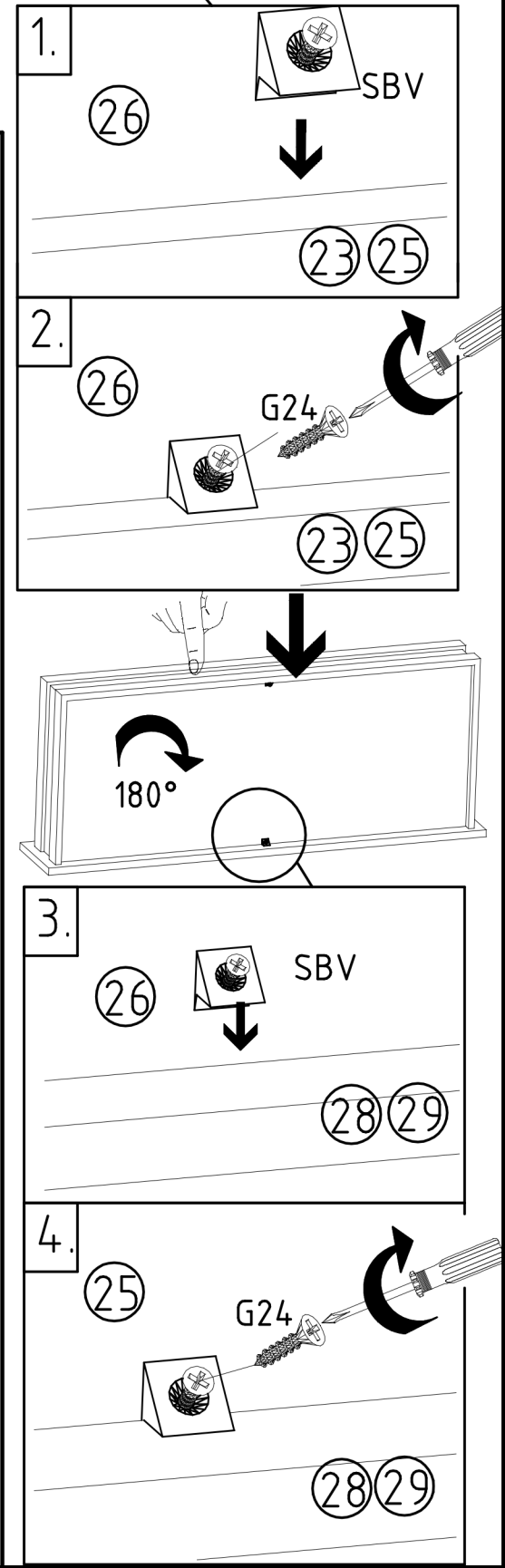
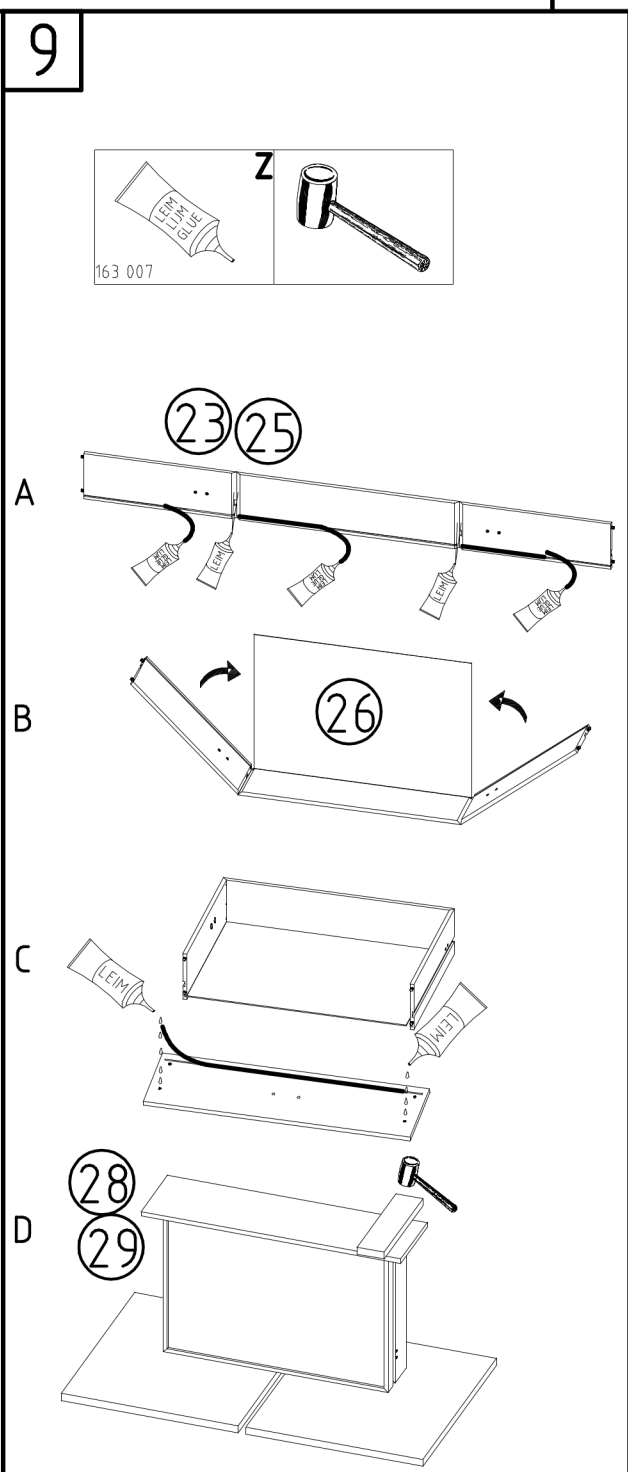
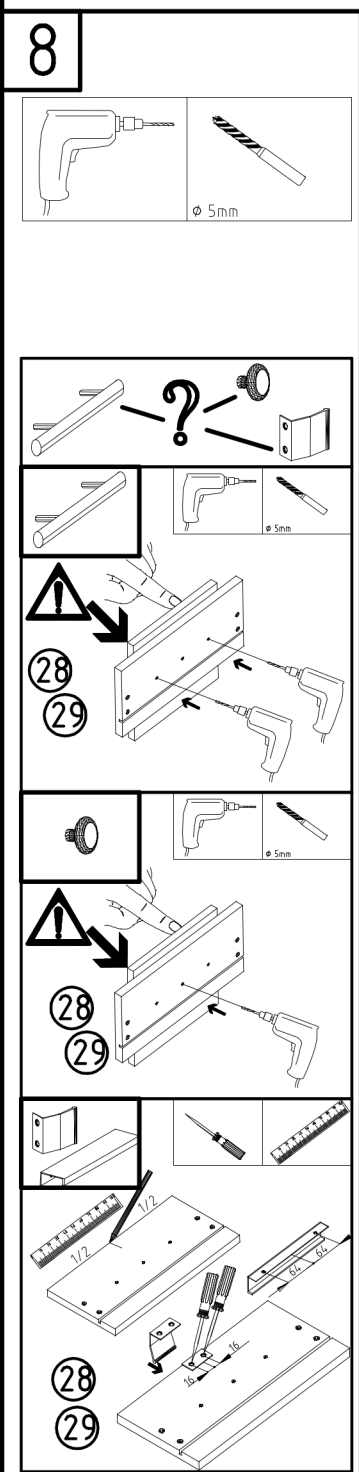
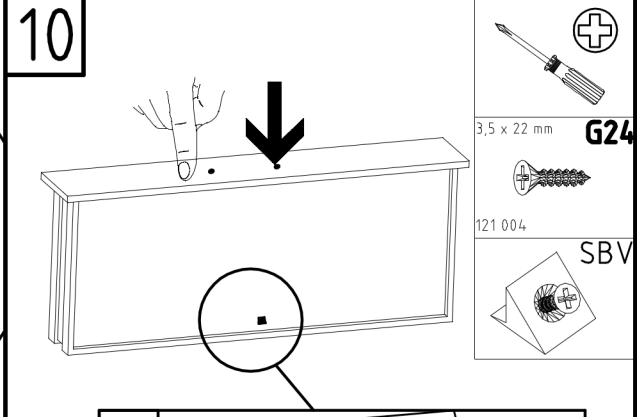
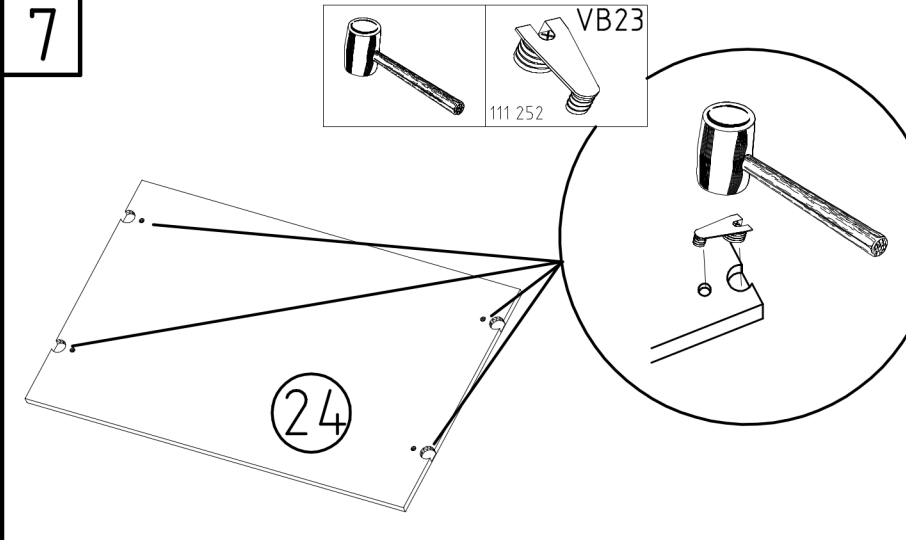

11

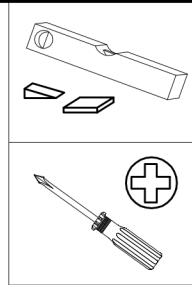
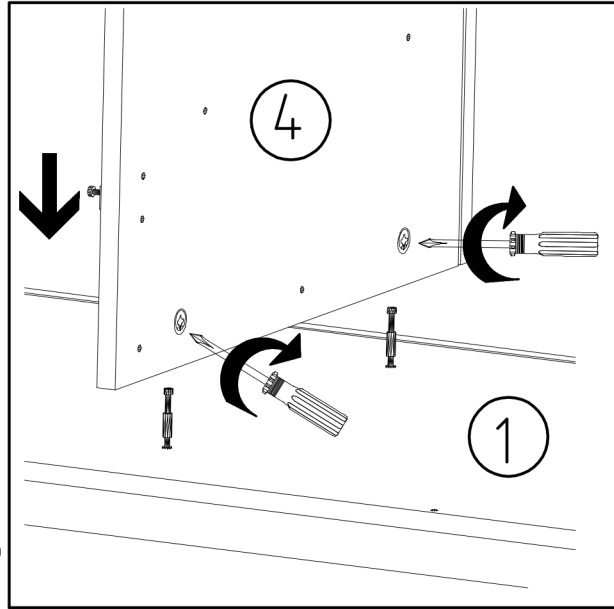
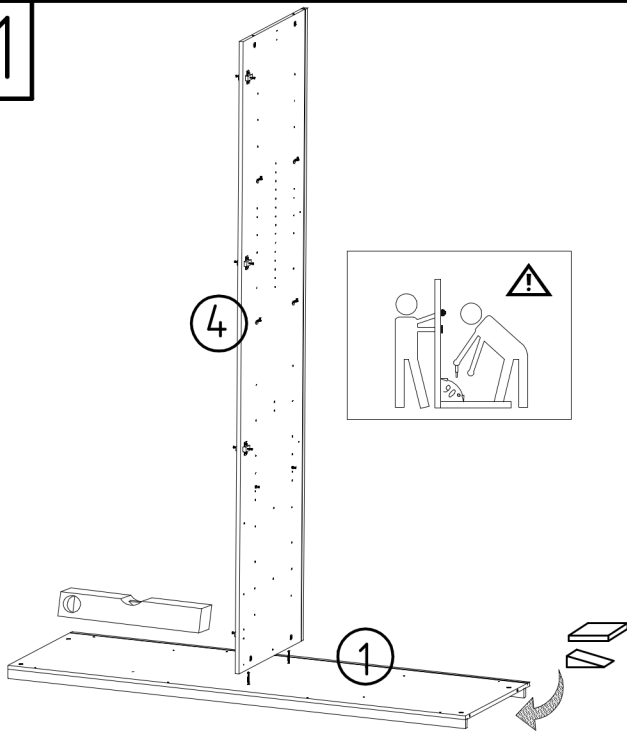

12

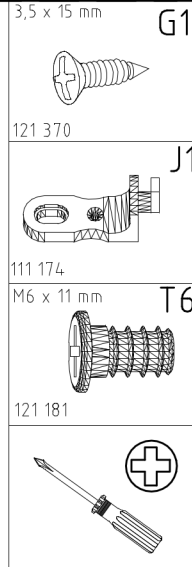
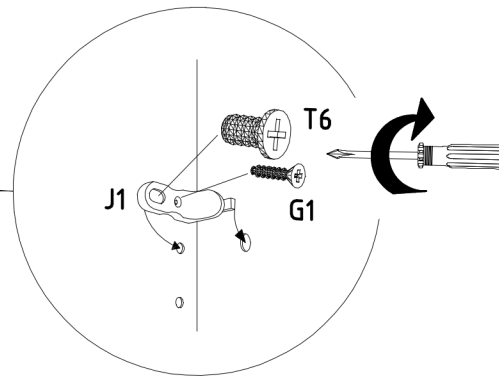
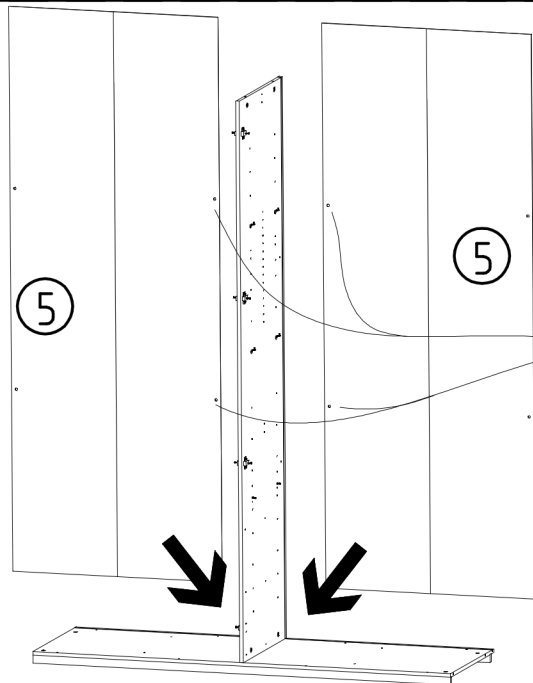

13

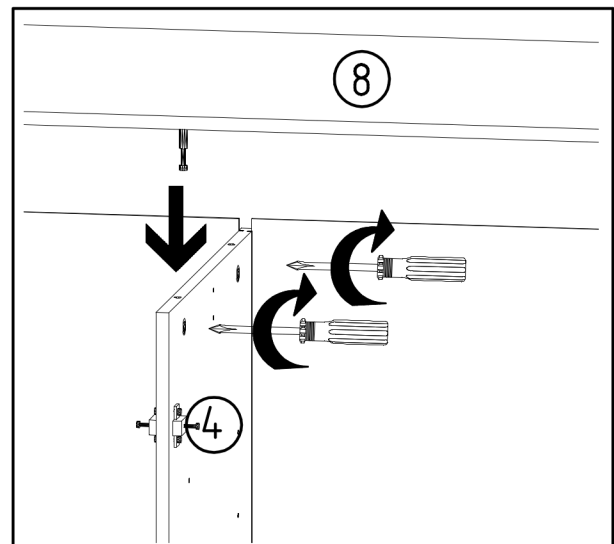
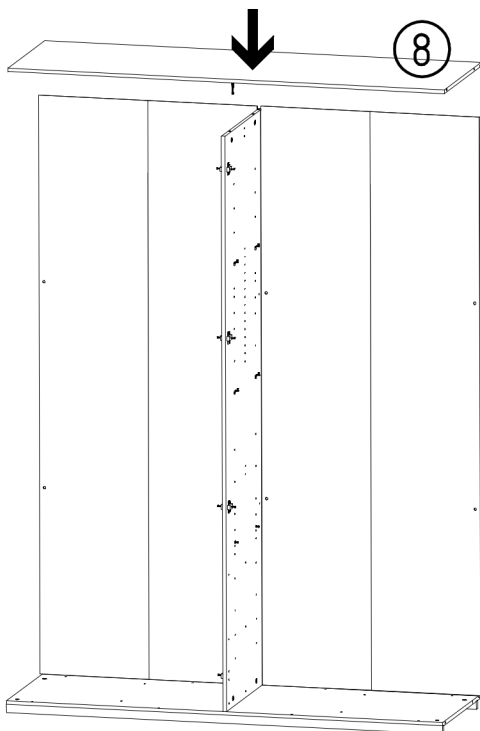



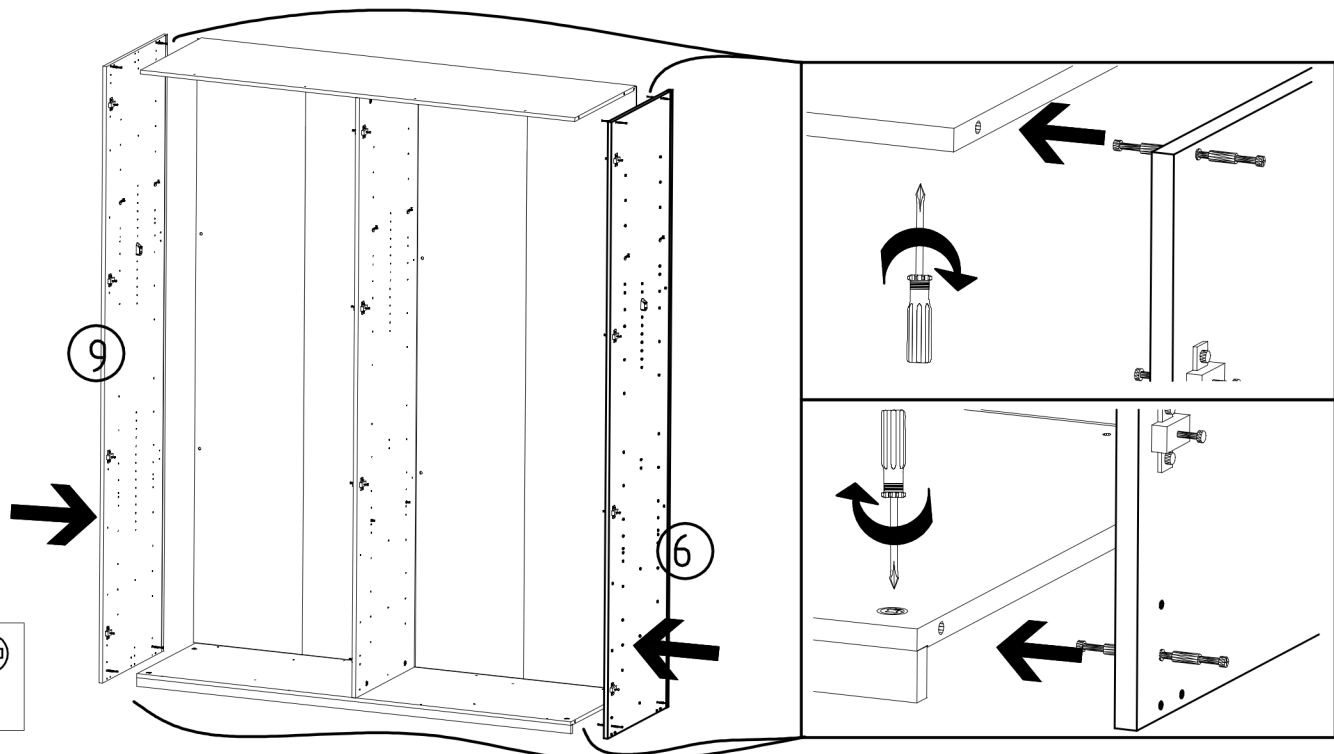

14

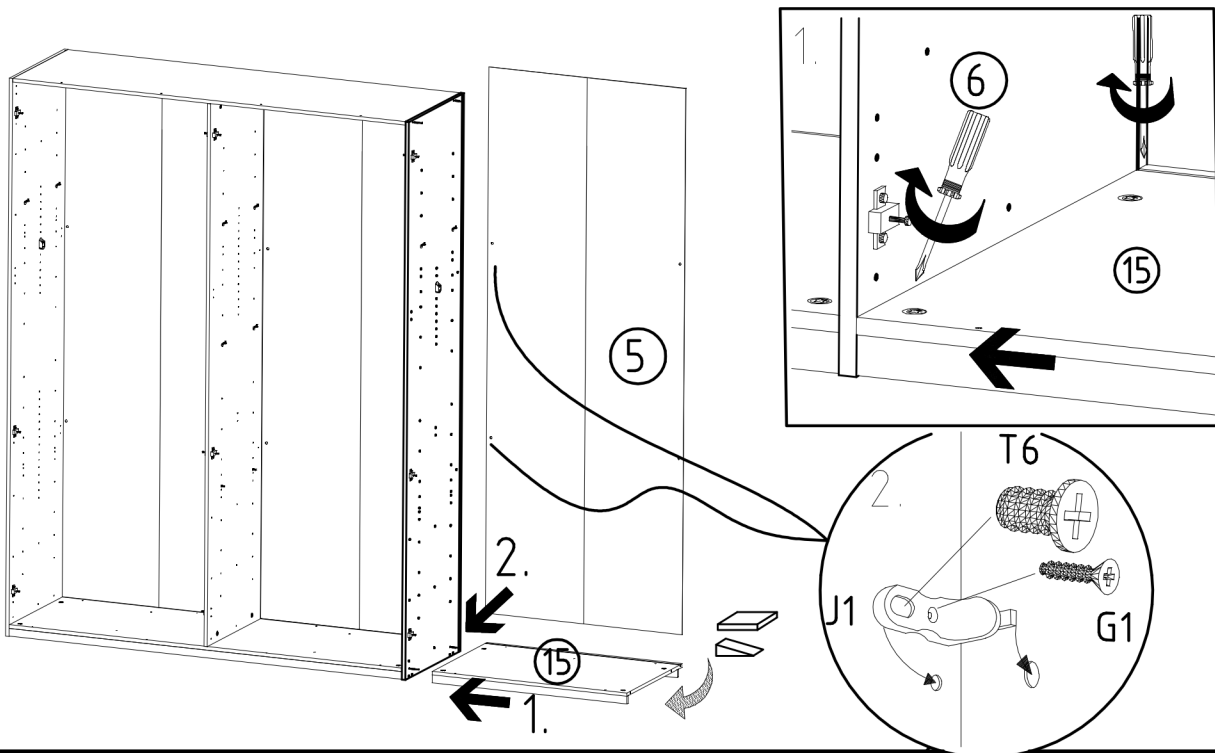

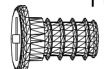

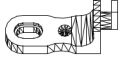

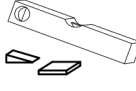
15

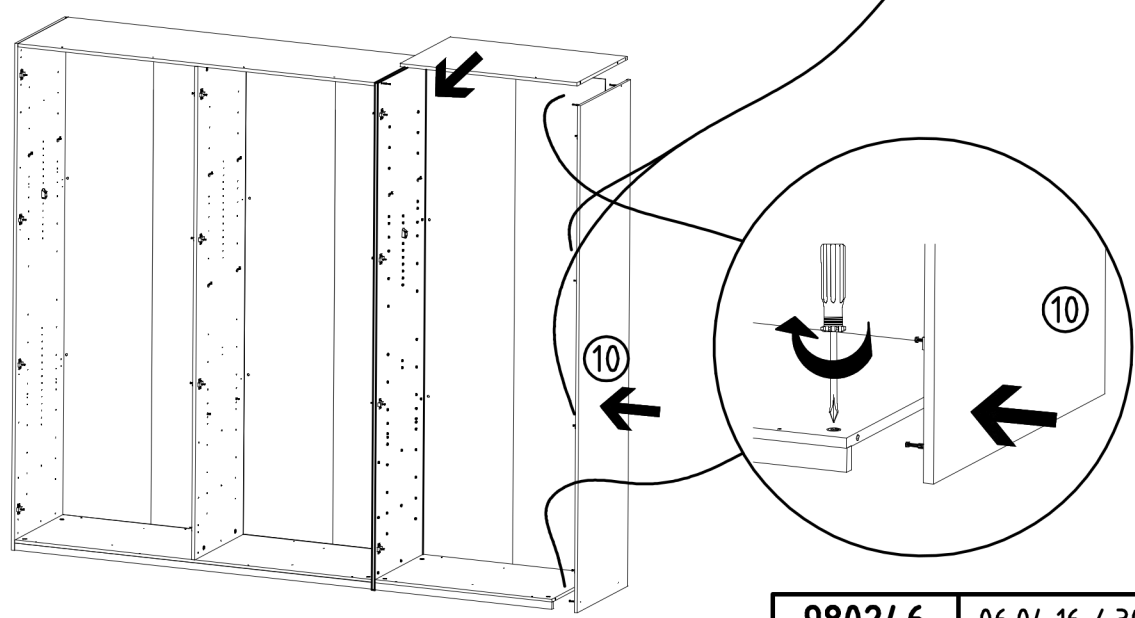

- M6 x 11 mm T6 
- 121 181
- 3,5 x 15 mm G1 
- 121 370
- J1 
- 111 174
- 
- 

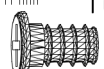
16

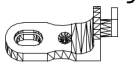

- M6 x 11 mm T6 
- 121 181
- 3,5 x 15 mm G1 
- 121 370
- J1 
- 111 174
- 

17

870mm
K20
112 402



18

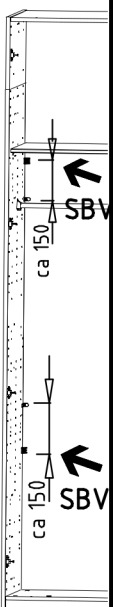
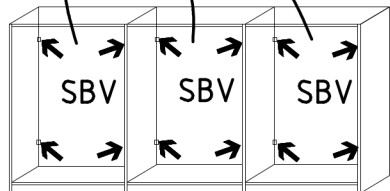
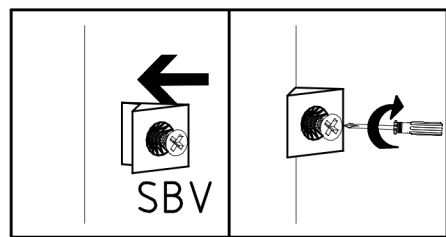
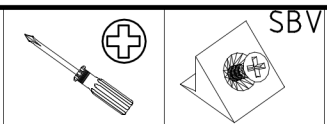

19

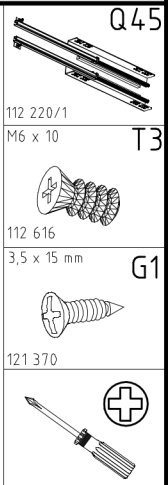
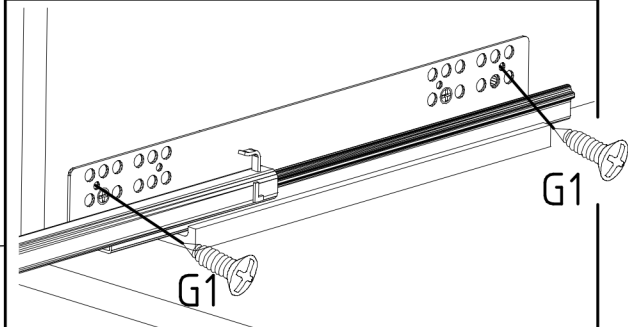
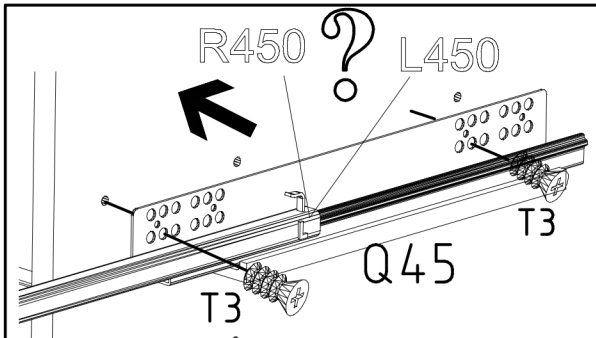
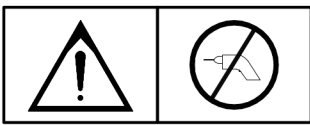
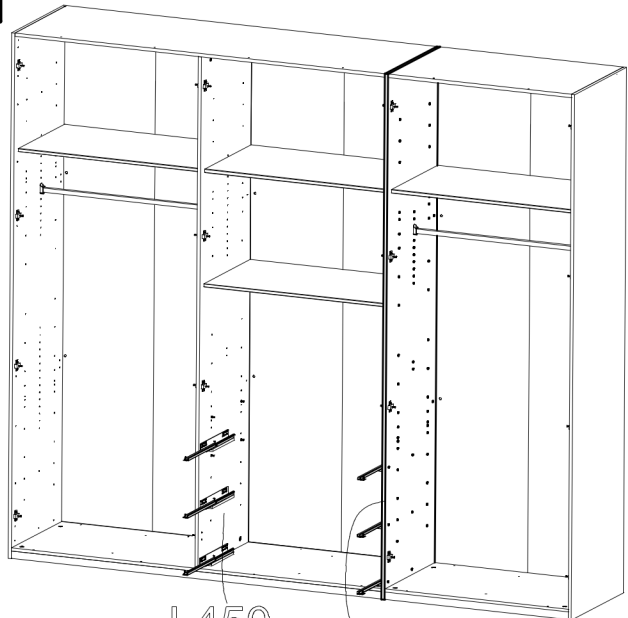

20

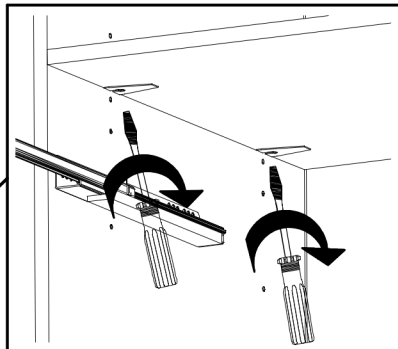
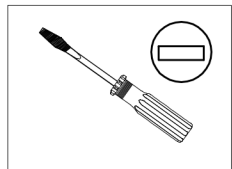
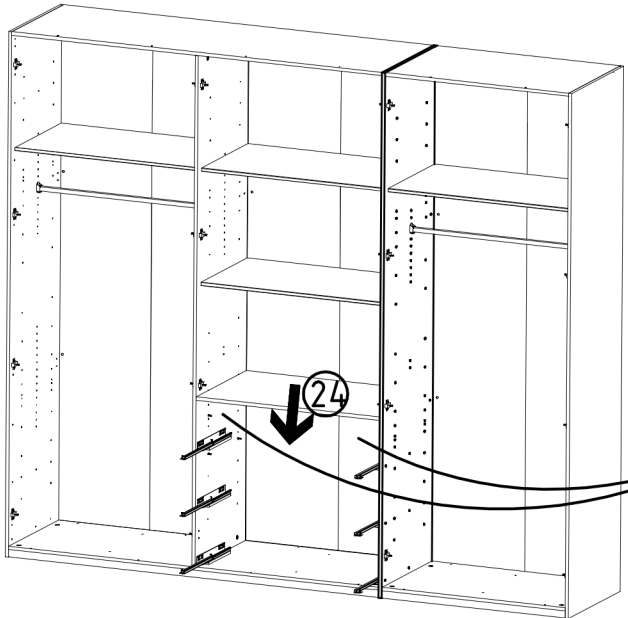

21

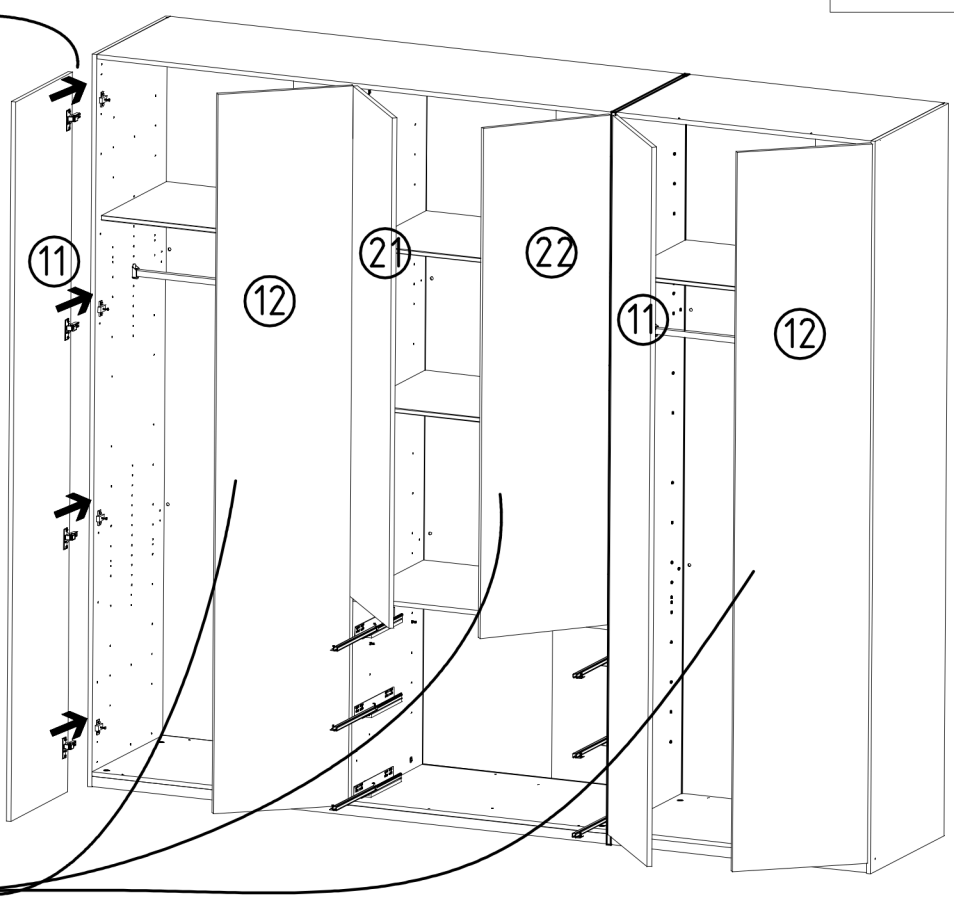
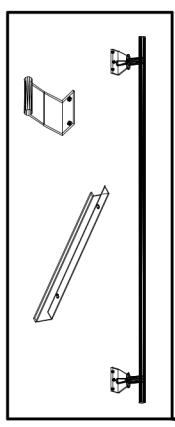
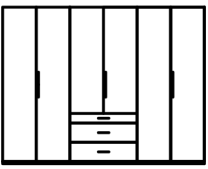
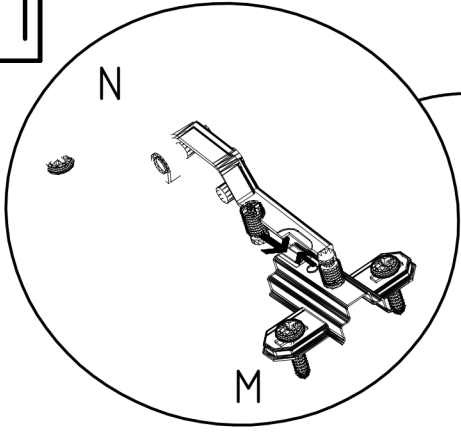
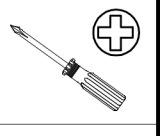

22

3,5 x 15 mm

G

AW1

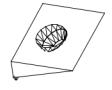
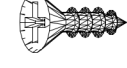

131370

xxx xxx

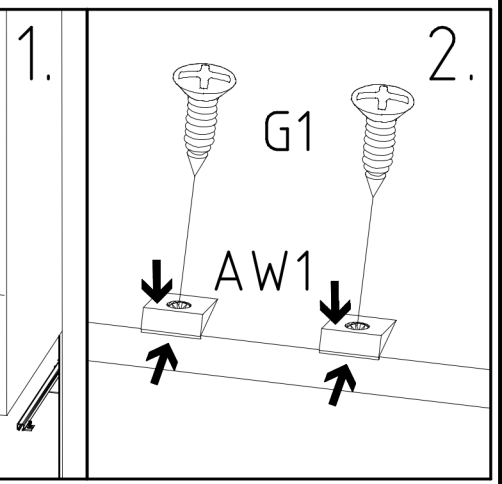
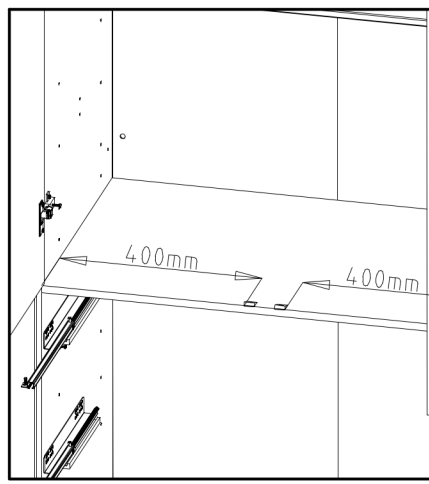
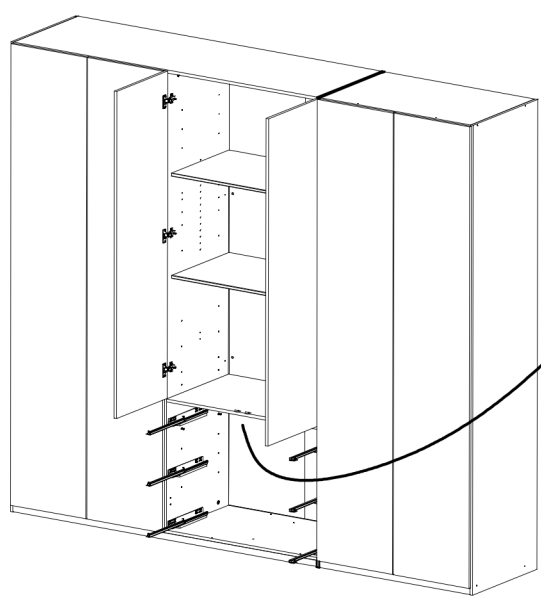

23

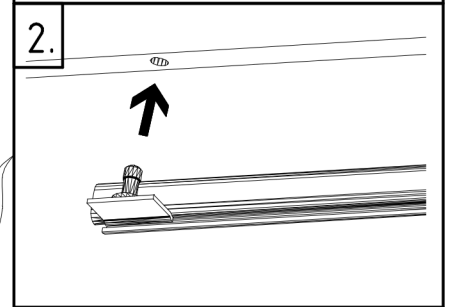
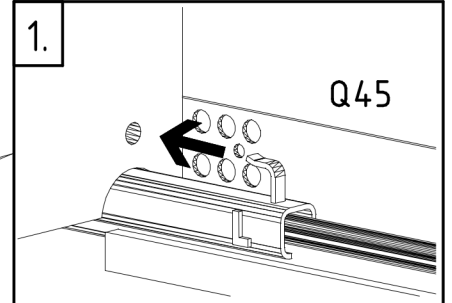
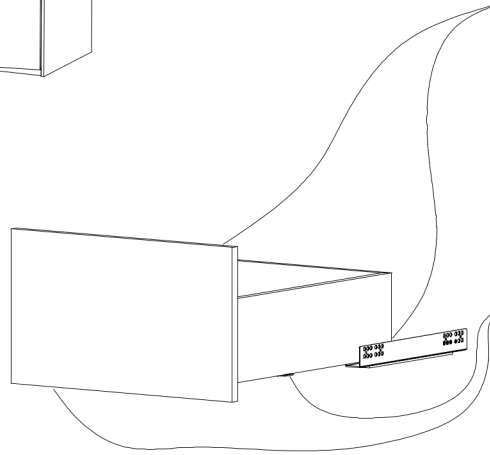
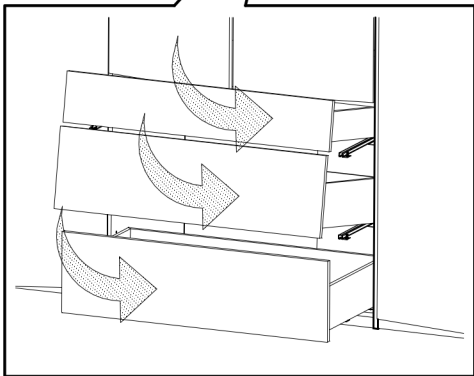
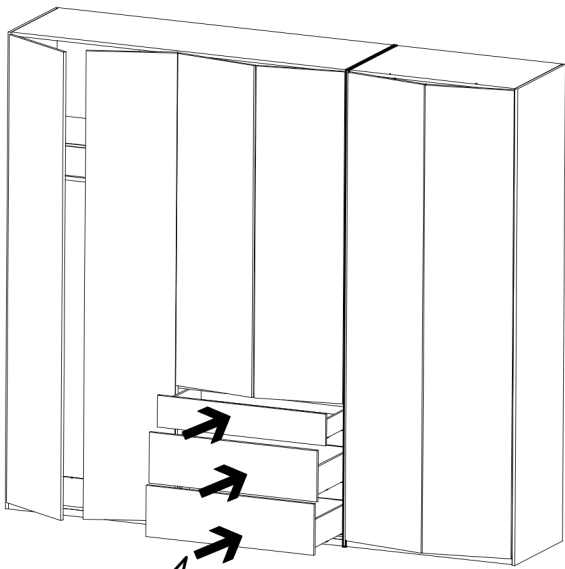

24

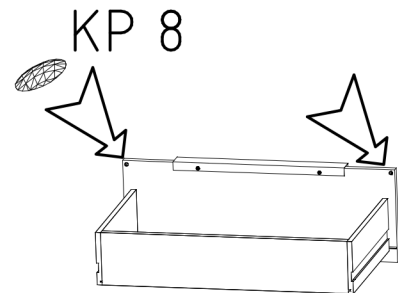
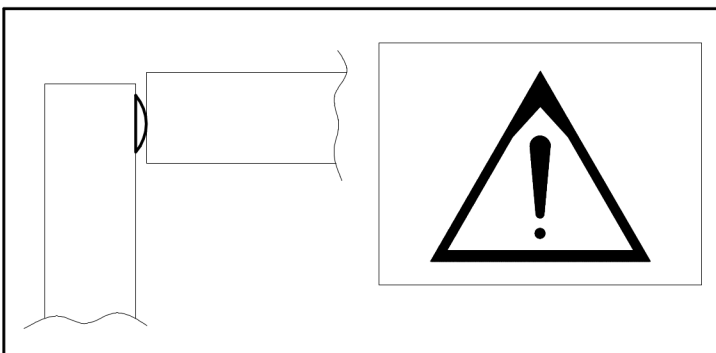
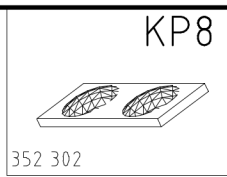
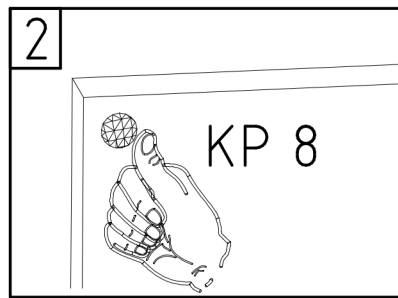
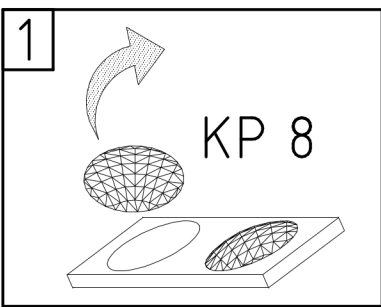

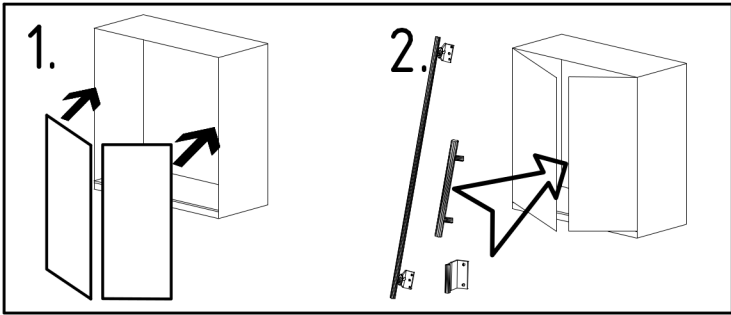

3,5 x 15 mm 121 370	G1	4,0 x 12 mm 122 625	G56
------------------------	----	------------------------	-----

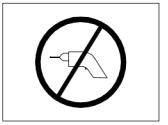
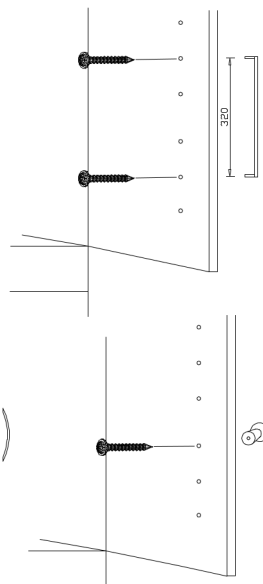
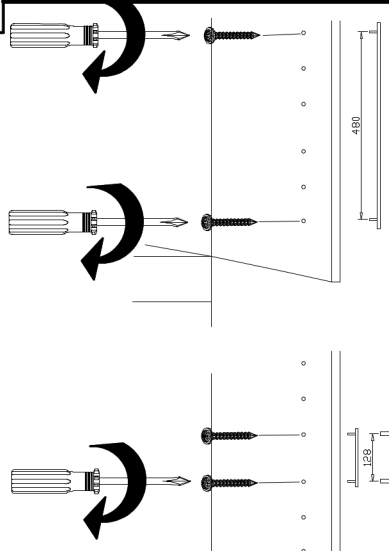
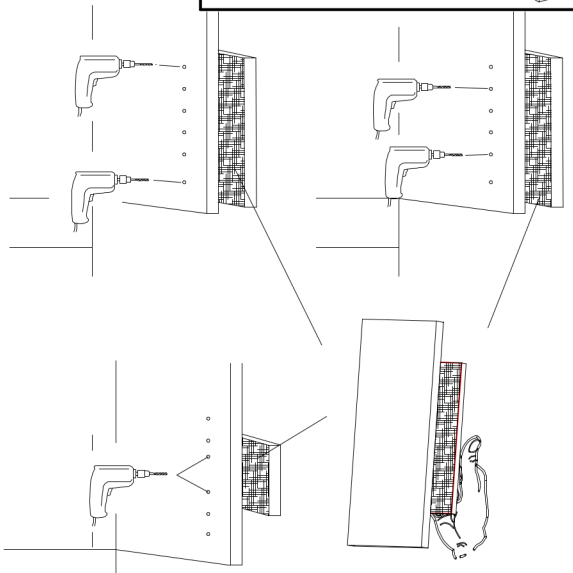
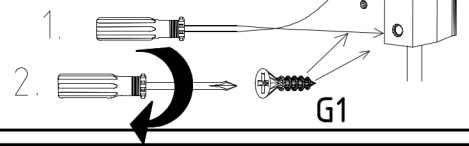
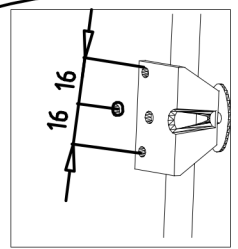
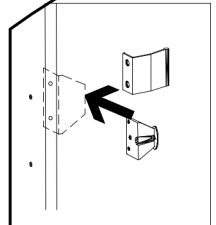
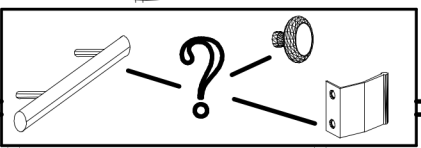
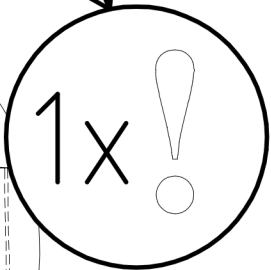
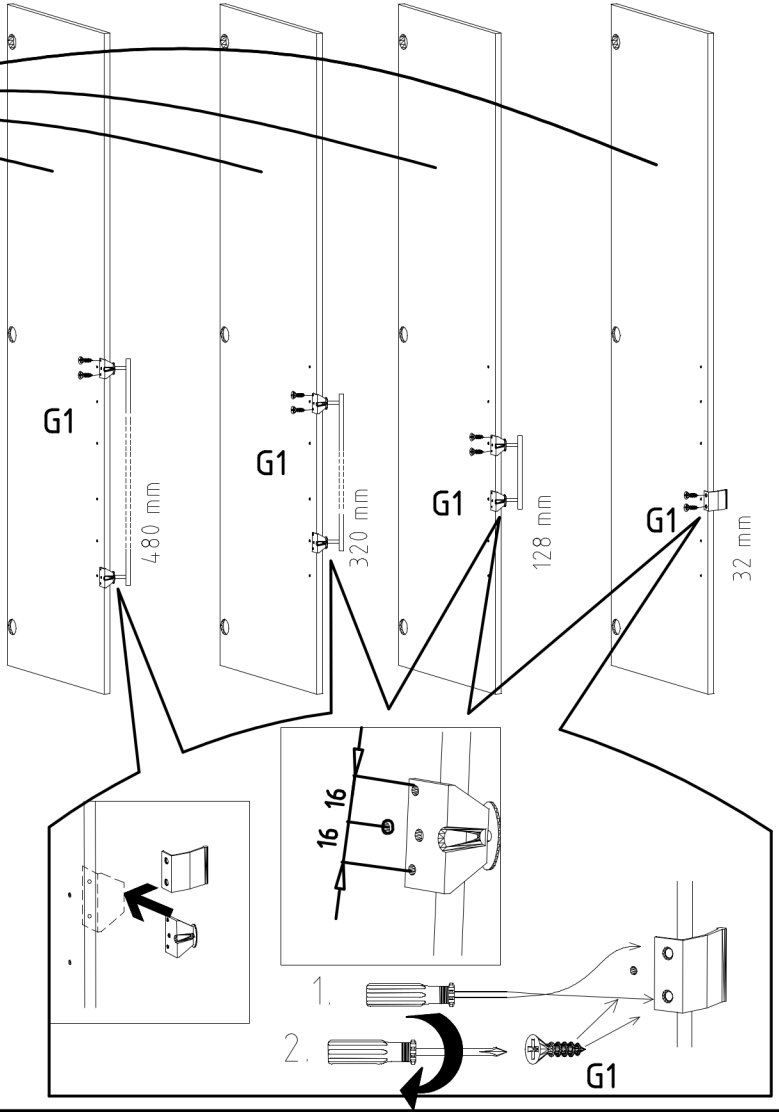
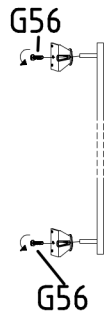
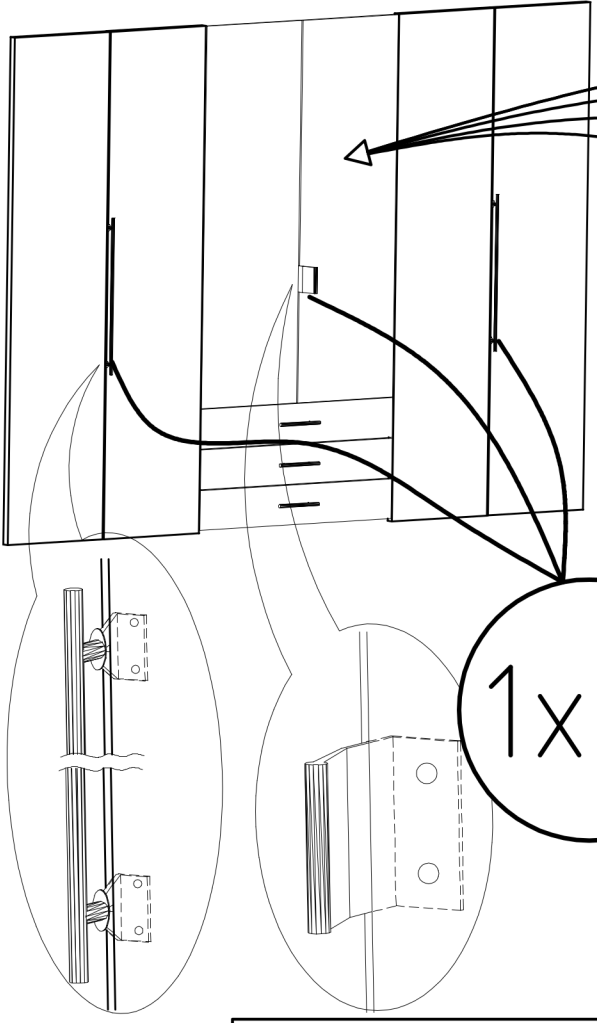

	SP27
	4 X 27mm
122620	G49
4,0x22	
122 609	

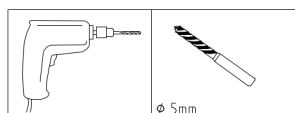

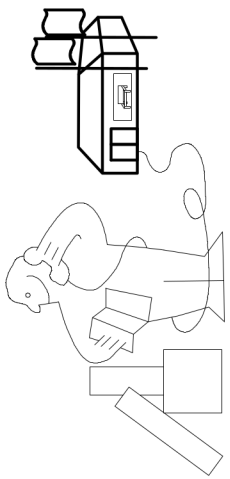
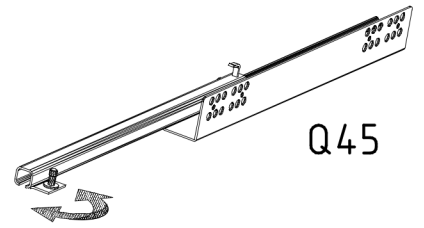
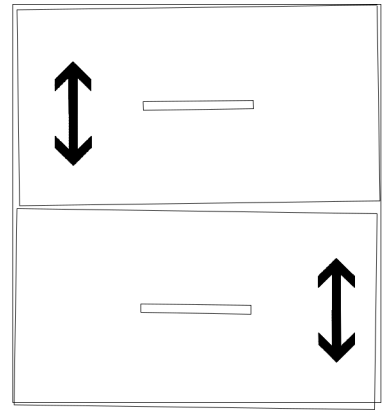
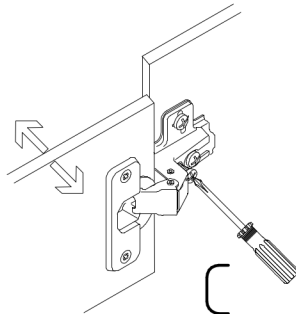
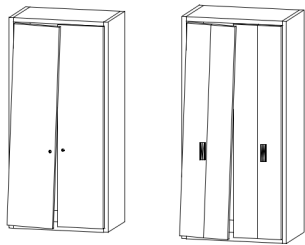
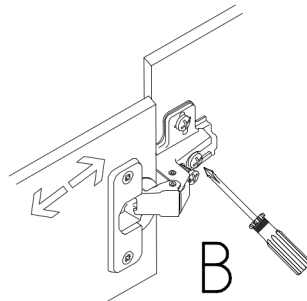
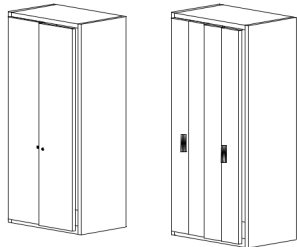
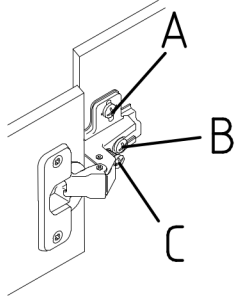
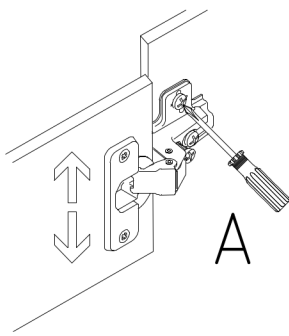

Modell/Model/Modèle

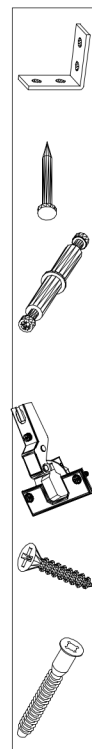
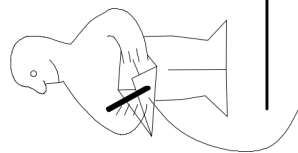
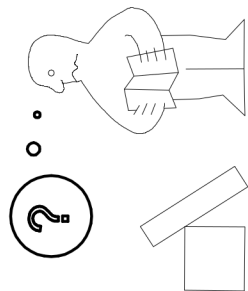
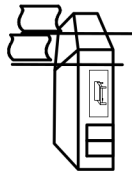
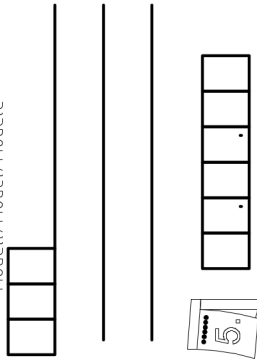

(121 370)	(G 1)	(4x)				