

980341

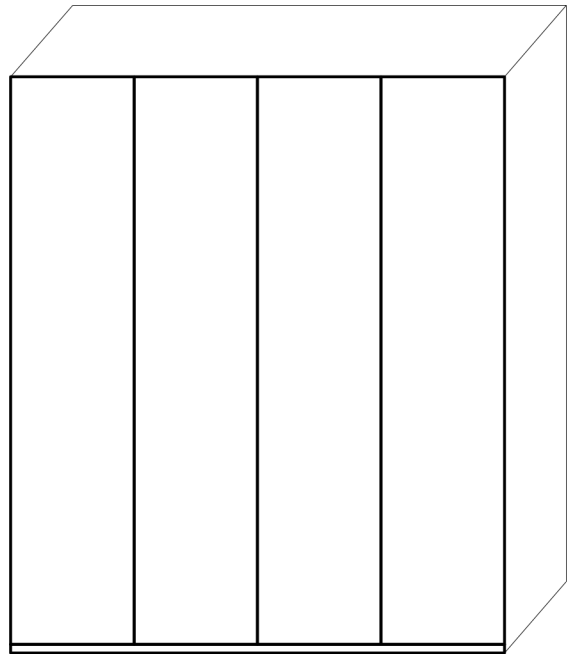

NSP 180

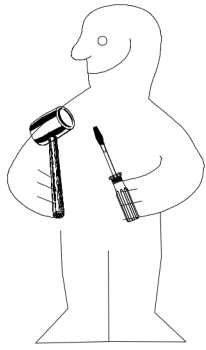
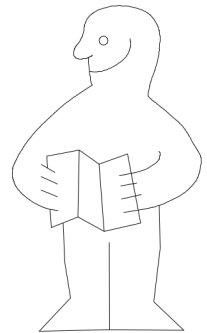
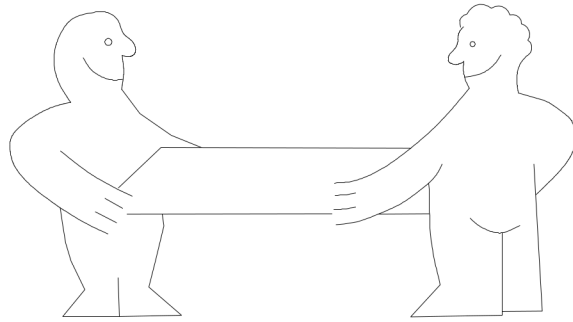
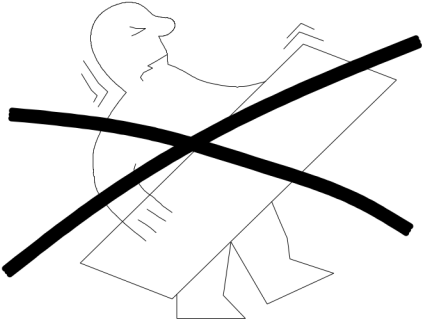

1-2-3-4... ○ ○

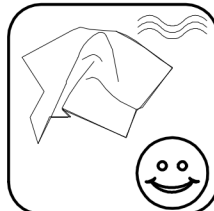
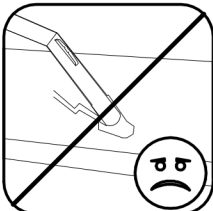
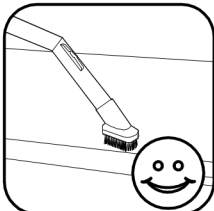
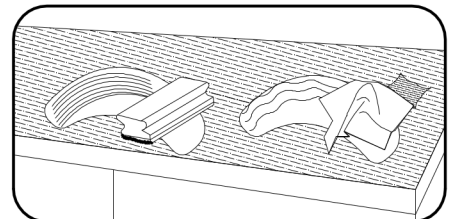
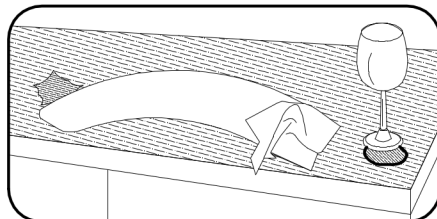
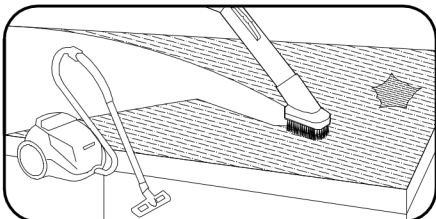
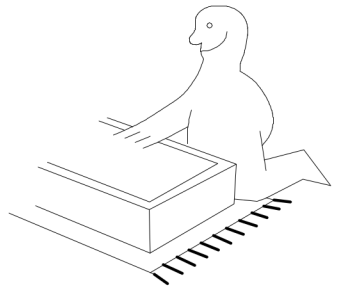
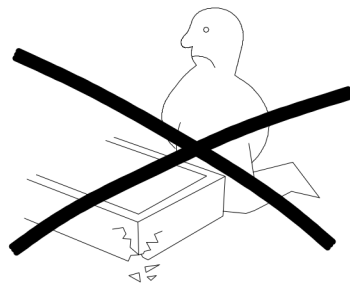
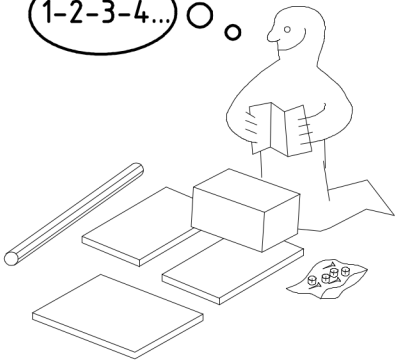



980341

02.12.04 / 13.07.12

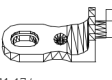

07 12

1/9

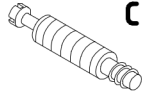
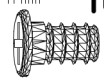
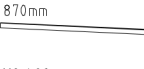
 111 102	<b>A</b> 12x
 111 610	<b>L7</b> 8x
 111 174	<b>J1</b> 4x

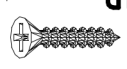
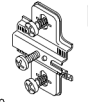
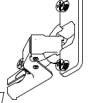
 111 103	<b>C</b> 12x
 M6 x 11 mm 121 181	<b>T6</b> 4x
 870mm 112 4.02	<b>K20</b> 2x

 3,5 x 35 mm 121 375	<b>G14</b> 8x
 112 268	<b>M</b> 12x
 112 267	<b>N</b> 12x

 117 001	<b>K1</b> 4x
 3,5 x 15 mm 121 370	<b>G1</b> 8x

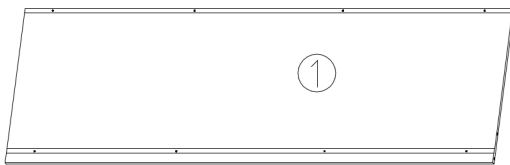
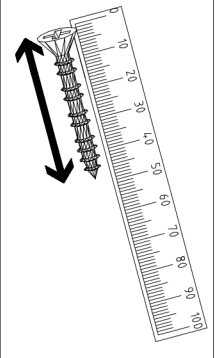
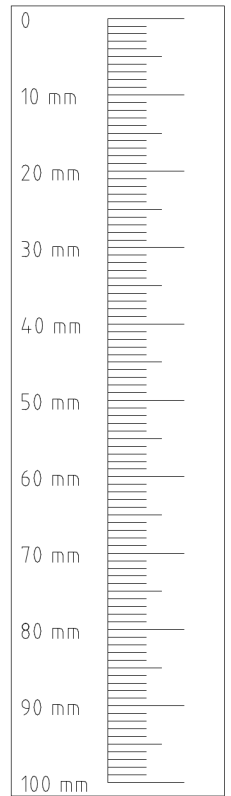

1761x560x15

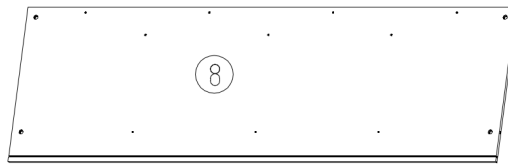

1761x560x15

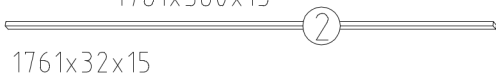

1761x32x15

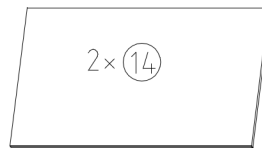

873x500x18



1761x32x15

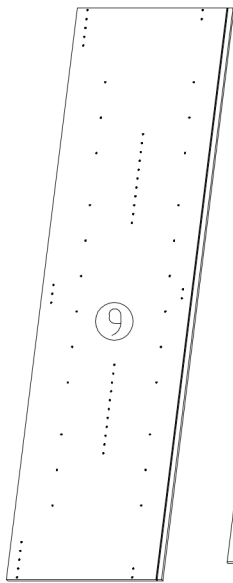

2064x560x15

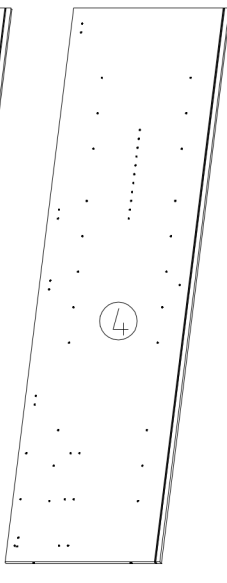

2001x560x15

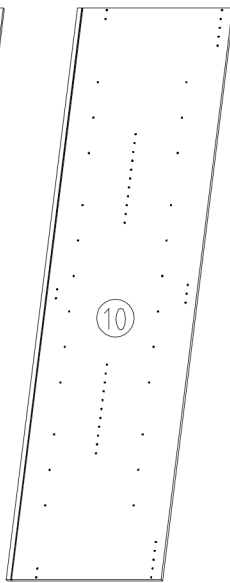

2064x560x15

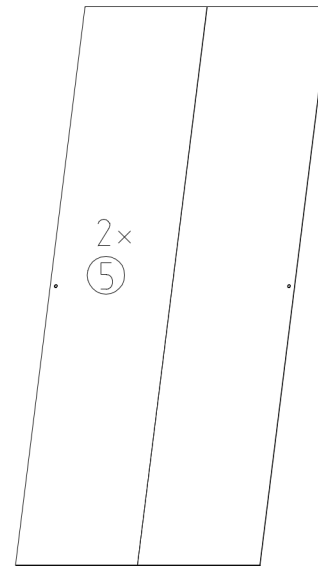

2015x882x2,5

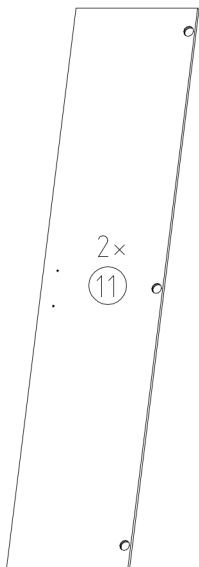

2021x439x15

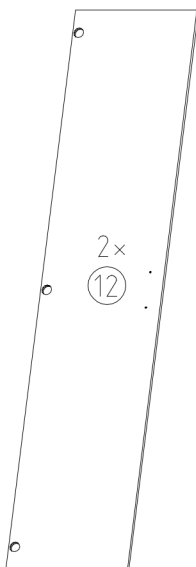

2021x439x15

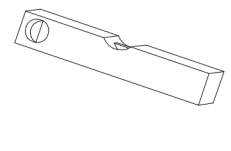
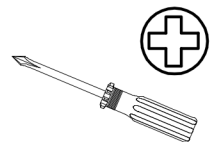
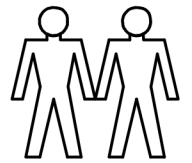

1

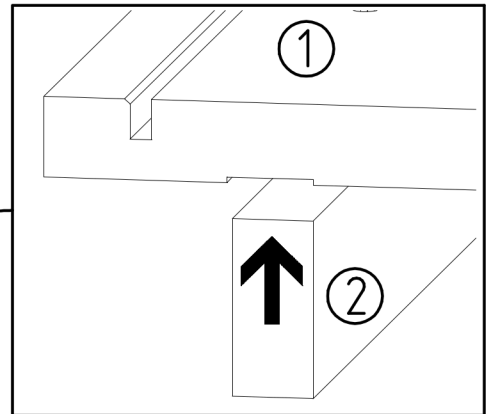
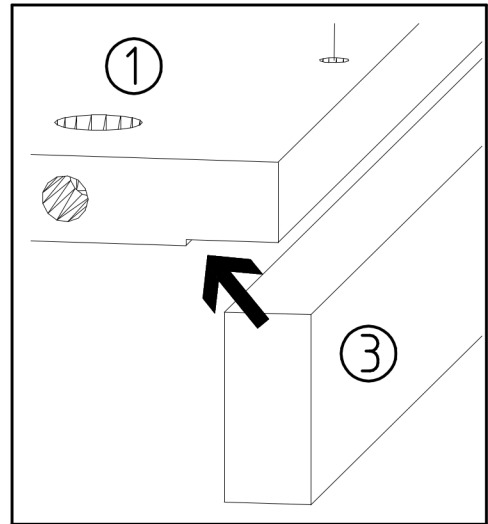
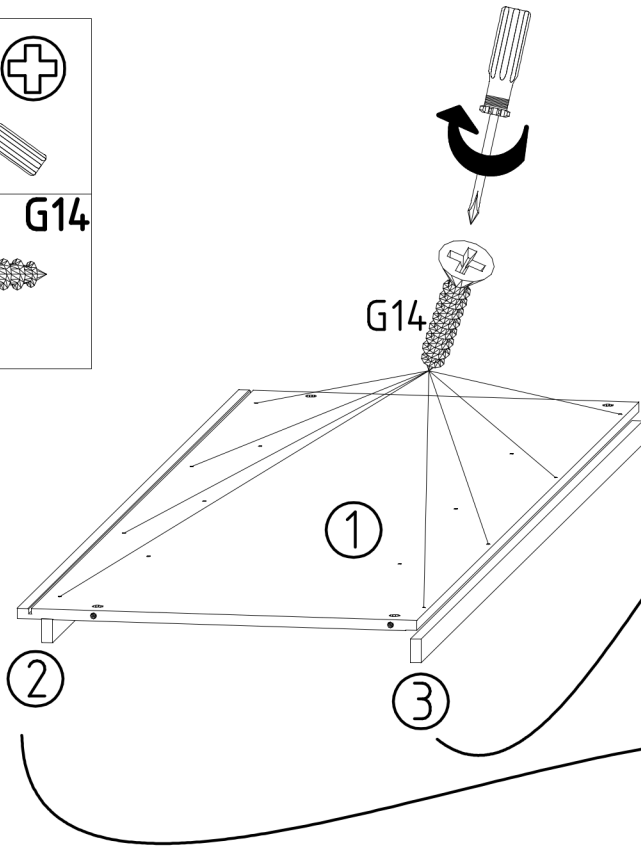
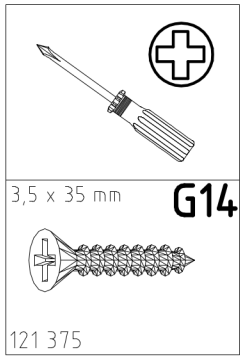



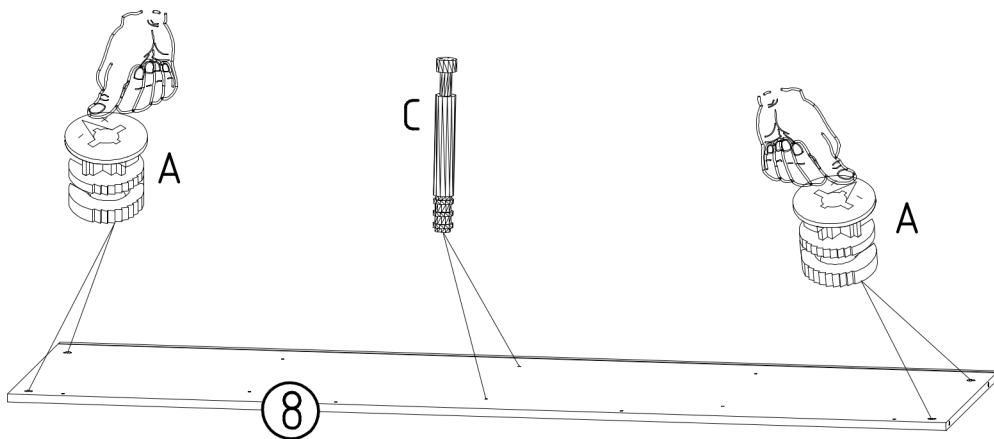
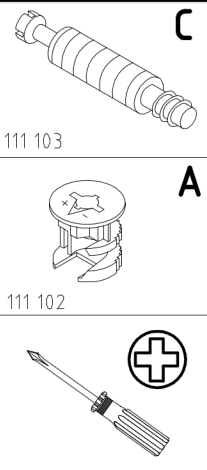
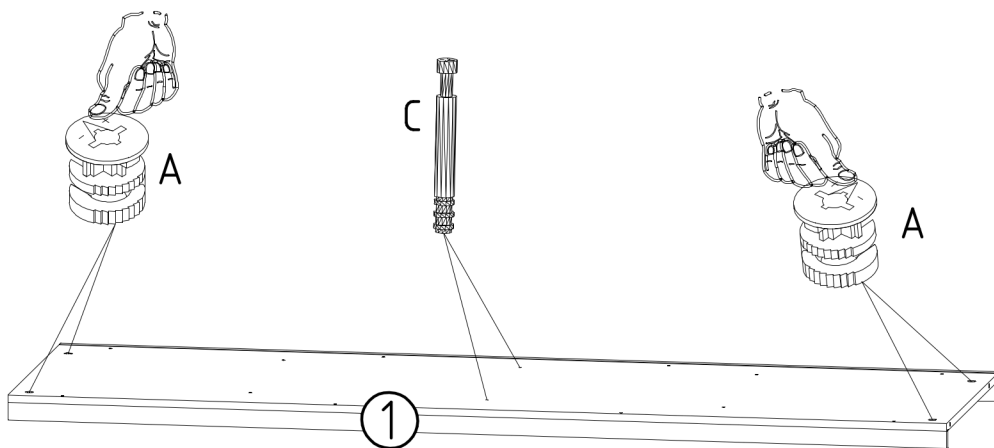

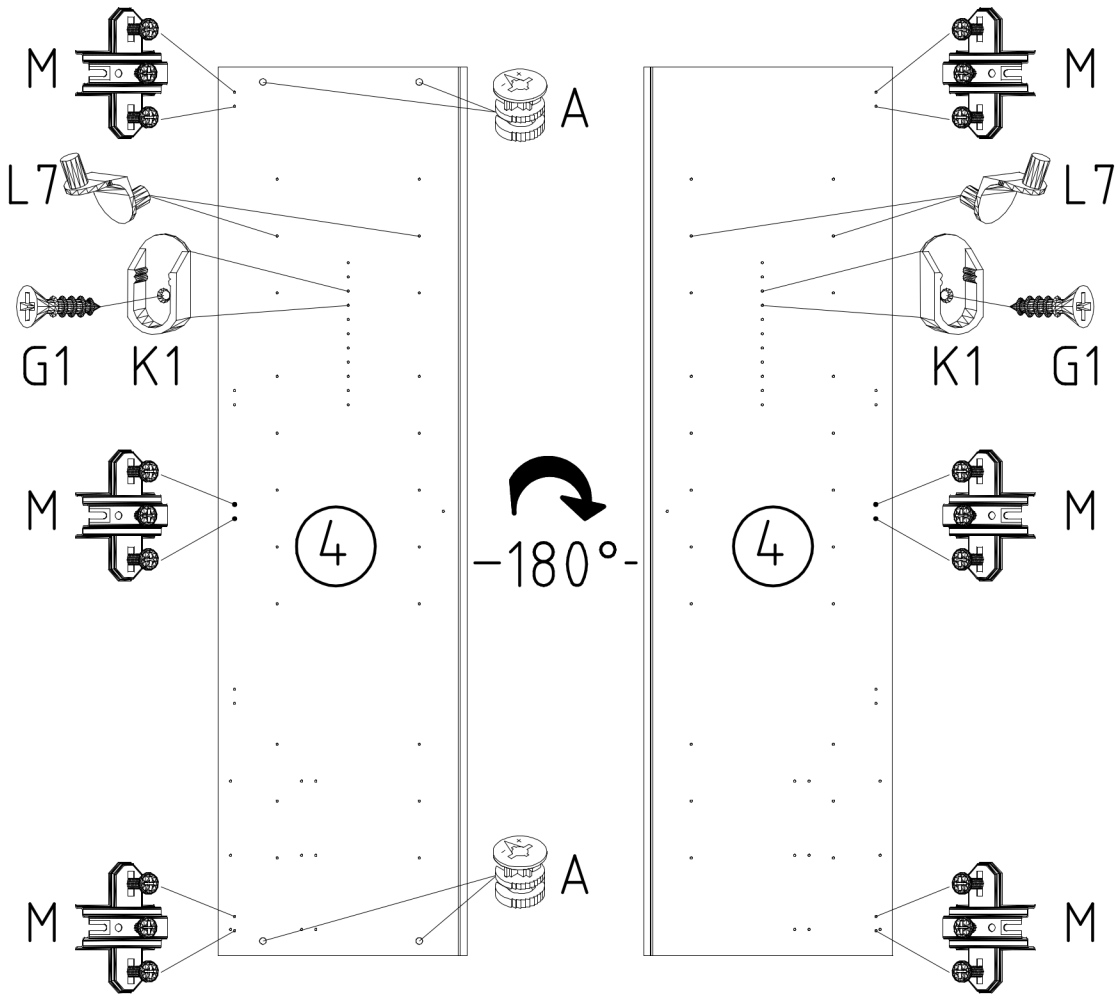

2





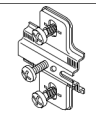



3

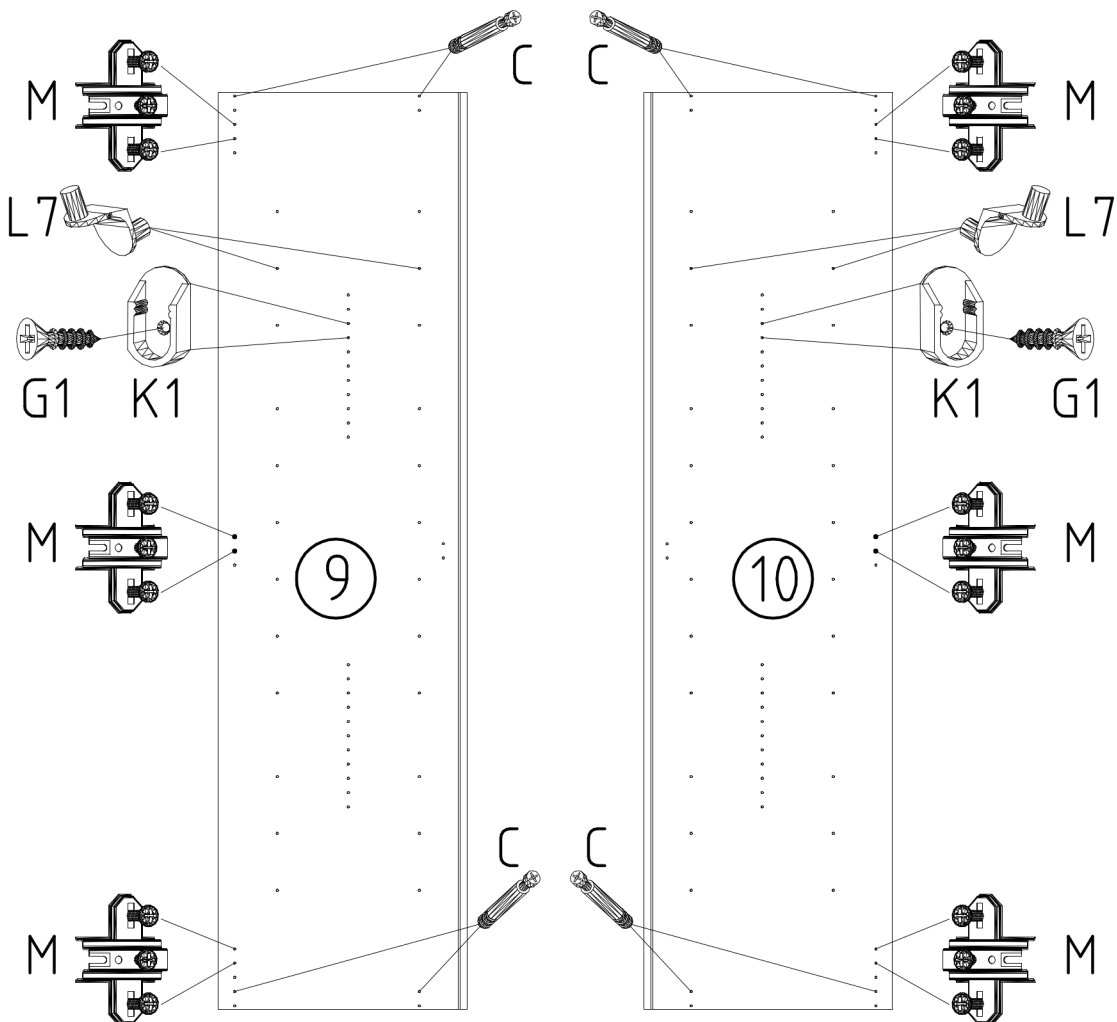

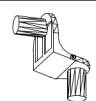
	<b>L7</b>
111 610	
	
3,5 x 15 mm	<b>G1</b>
	
121 370	
	<b>A</b>
111 102	
	<b>M</b>
112 268	
	<b>K1</b>
117 001	

4

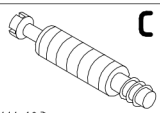
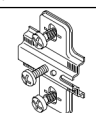

	<b>L7</b>
111 610	
	
3,5 x 15 mm	<b>G1</b>
	
121 370	
	<b>C</b>
111 103	
	<b>M</b>
112 268	
	<b>K1</b>
117 001	

5

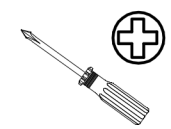
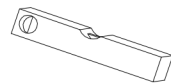
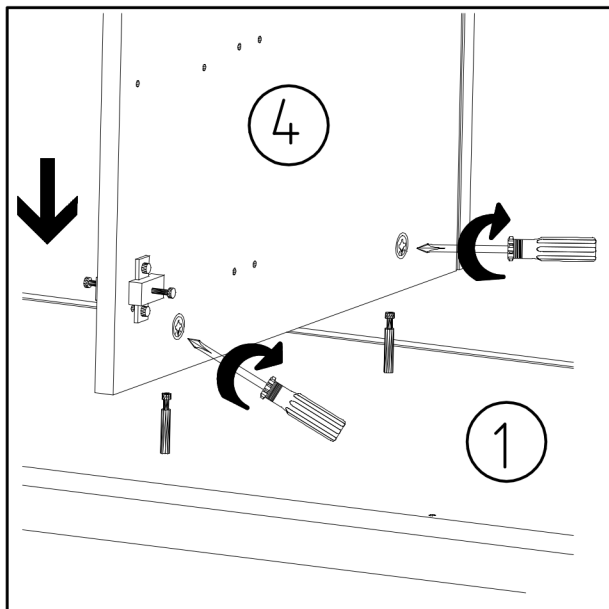
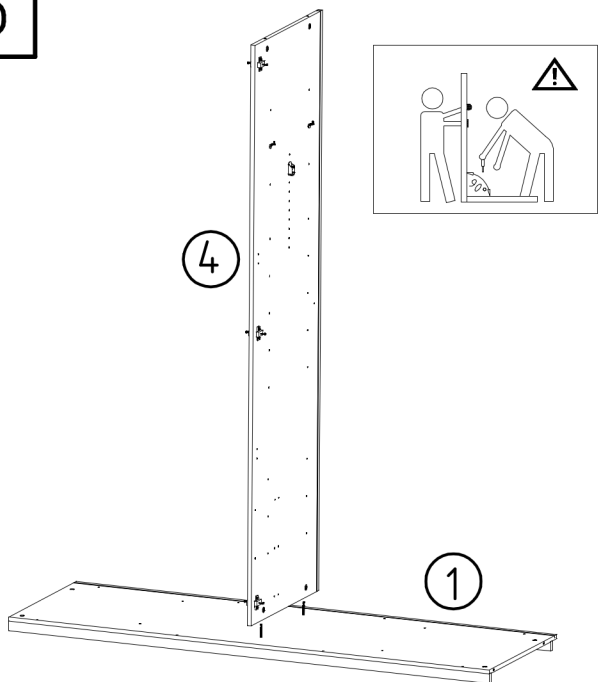

6

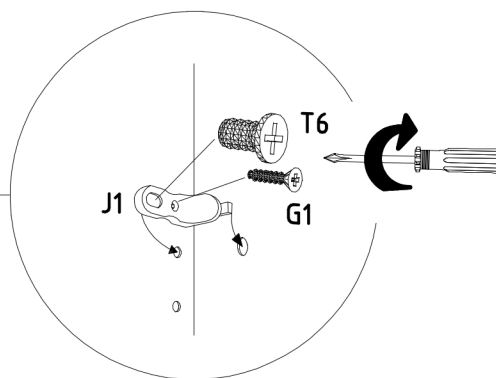
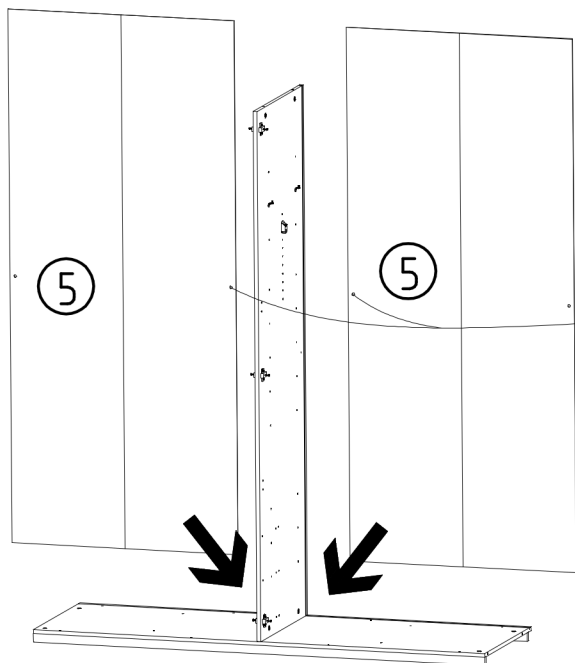

3,5 x 15 mm **G1**

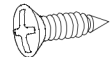

121 370

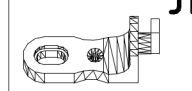

111 174

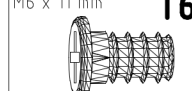

M6 x 11 mm **T6**

121 181

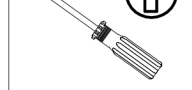

7

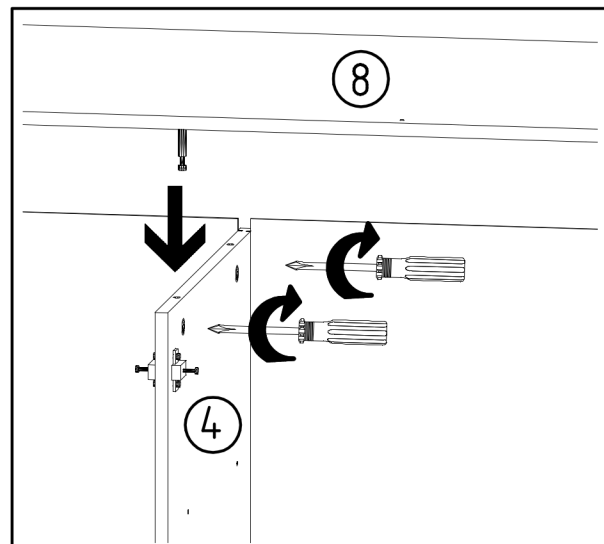
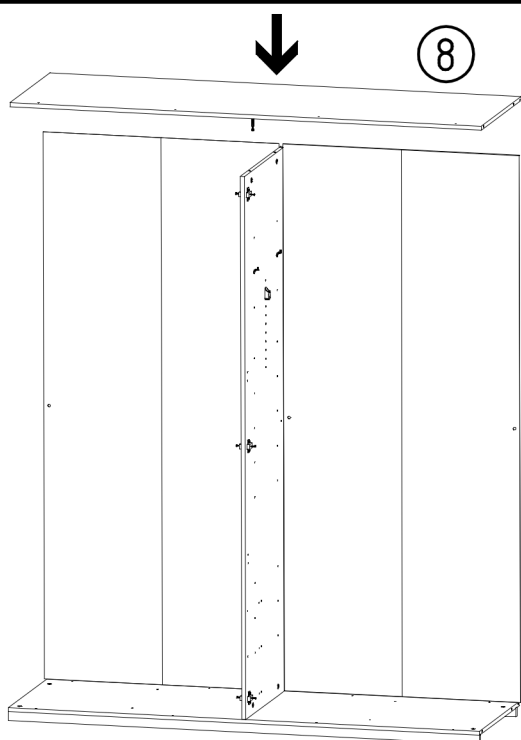

8

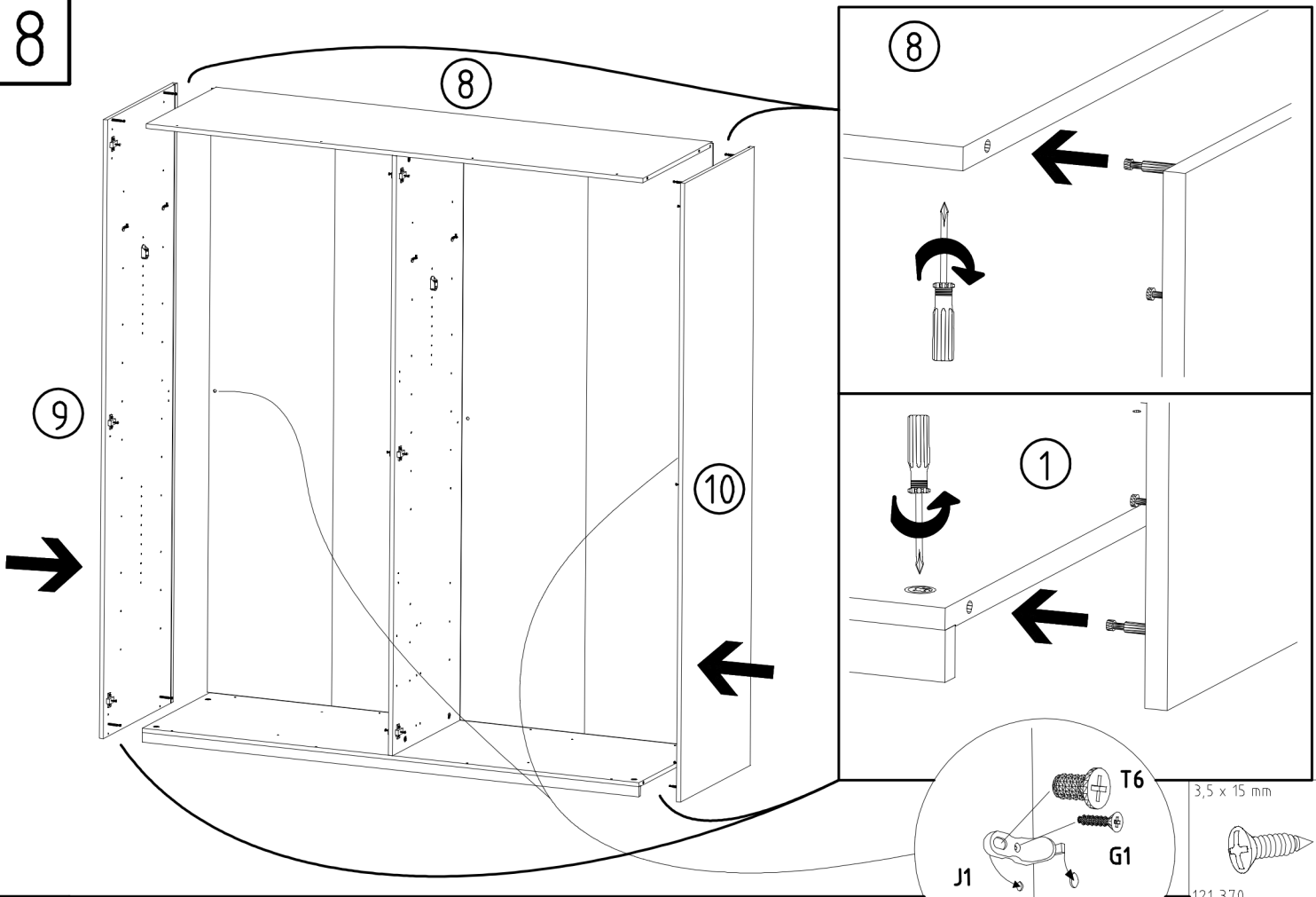

8

9

10

1

J1

T6

G1

3,5 x 15 mm

G1

121 370

J1

111 174

M6 x 11 mm

T6

121 181

9

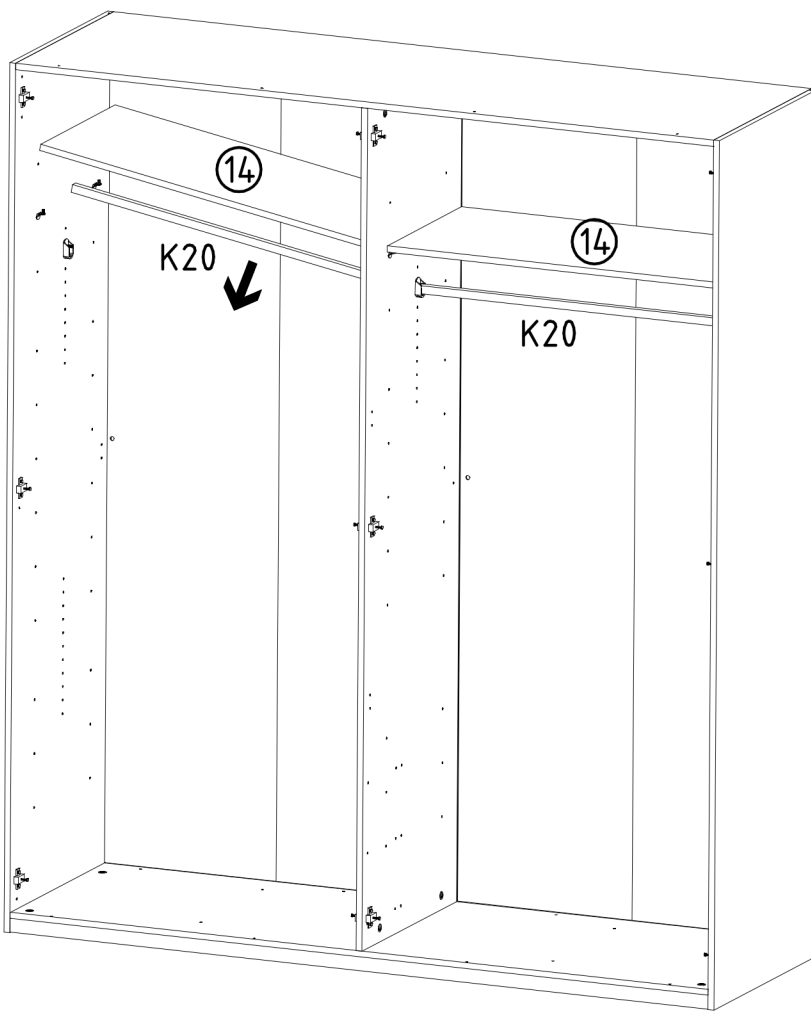

14

K20

14

K20

K20

870mm

112 402

980341

02.12.04 / 13.07.12

07 12

6/9

10

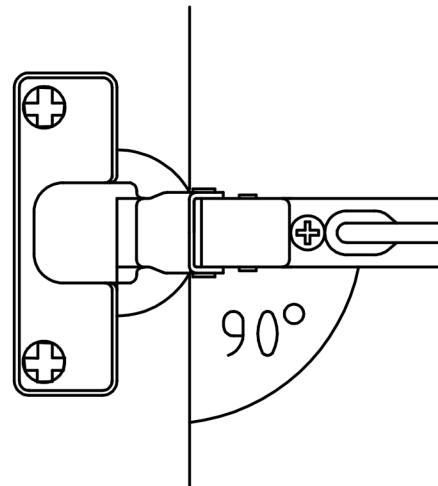
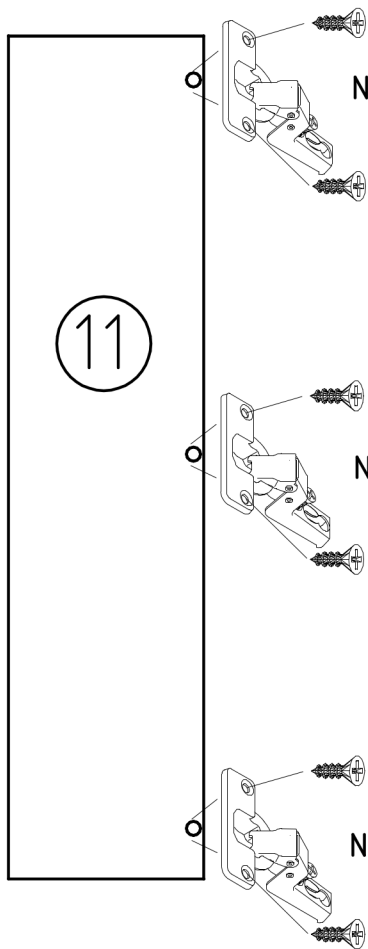
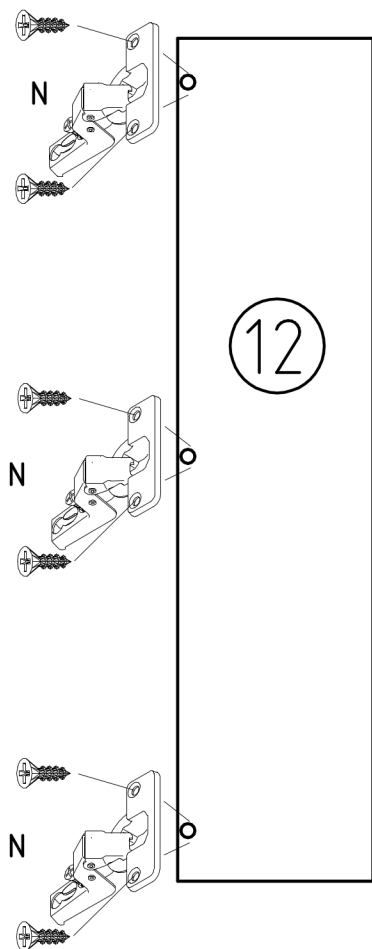
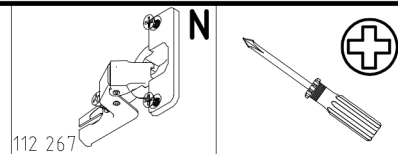

11

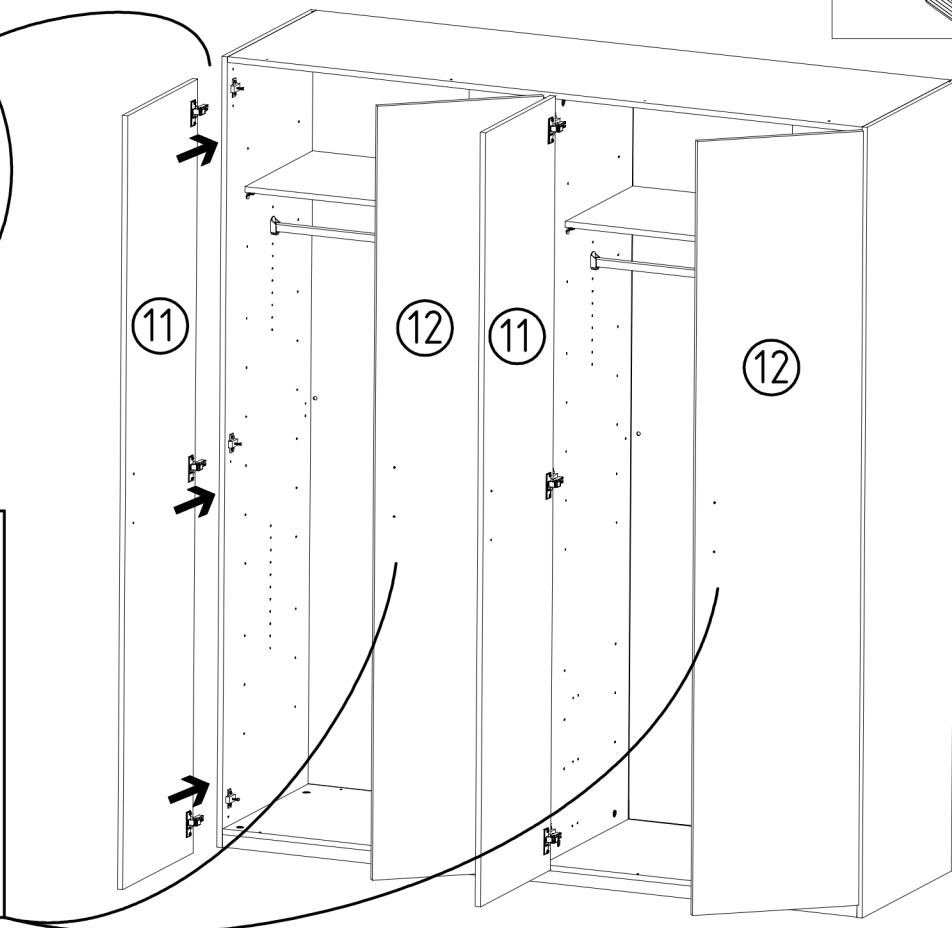
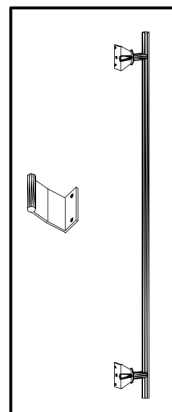
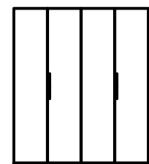
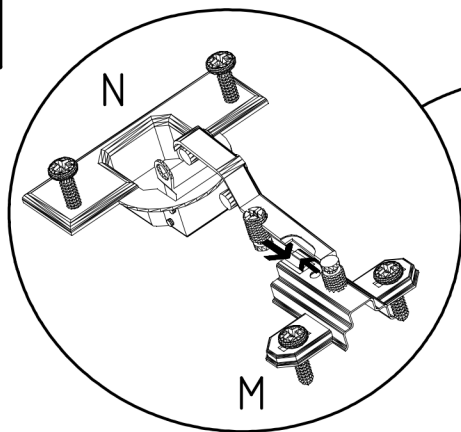
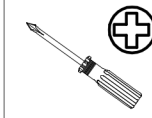

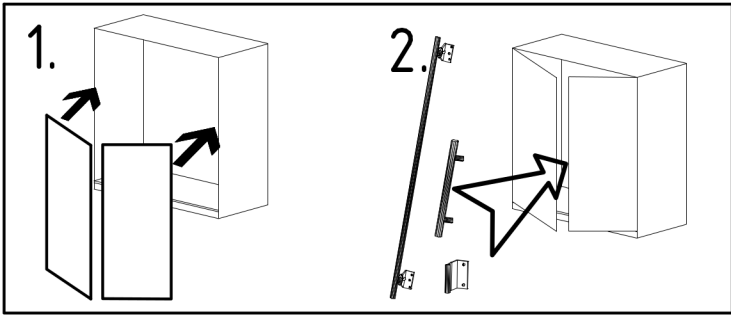

3,5 x 15 mm 121 370	<b>G1</b>	4,0 x 12 mm 122 625	<b>G56</b>
------------------------	-----------	------------------------	------------

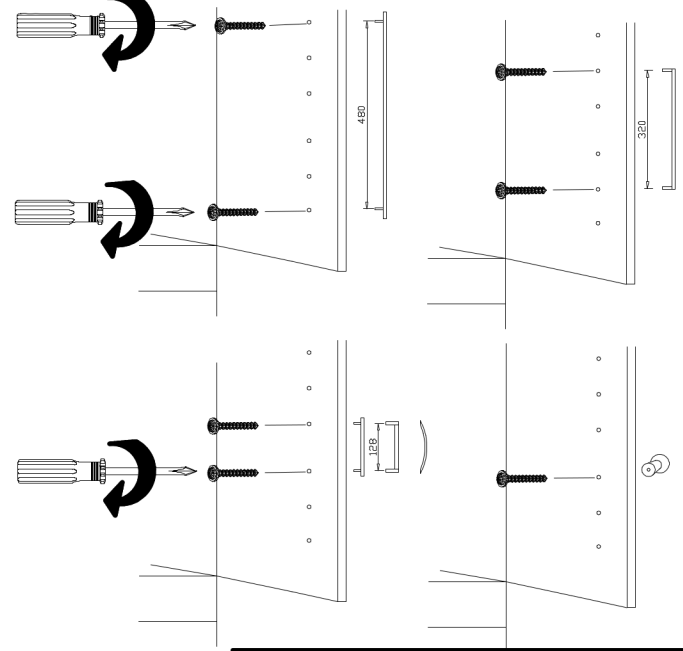
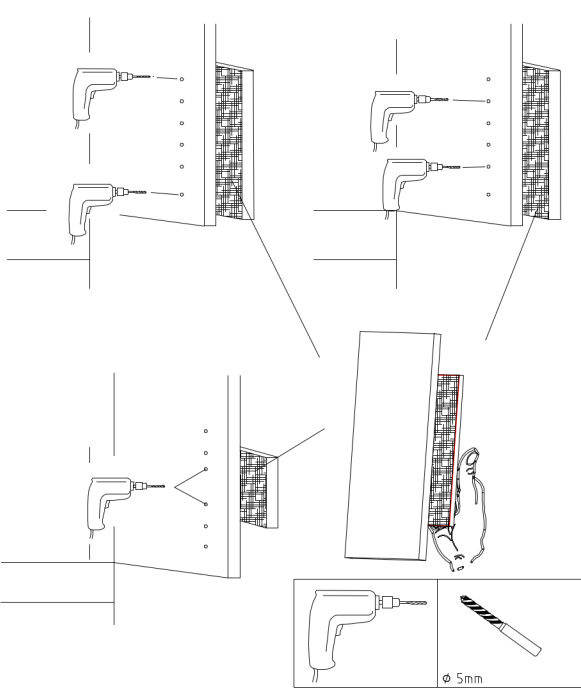
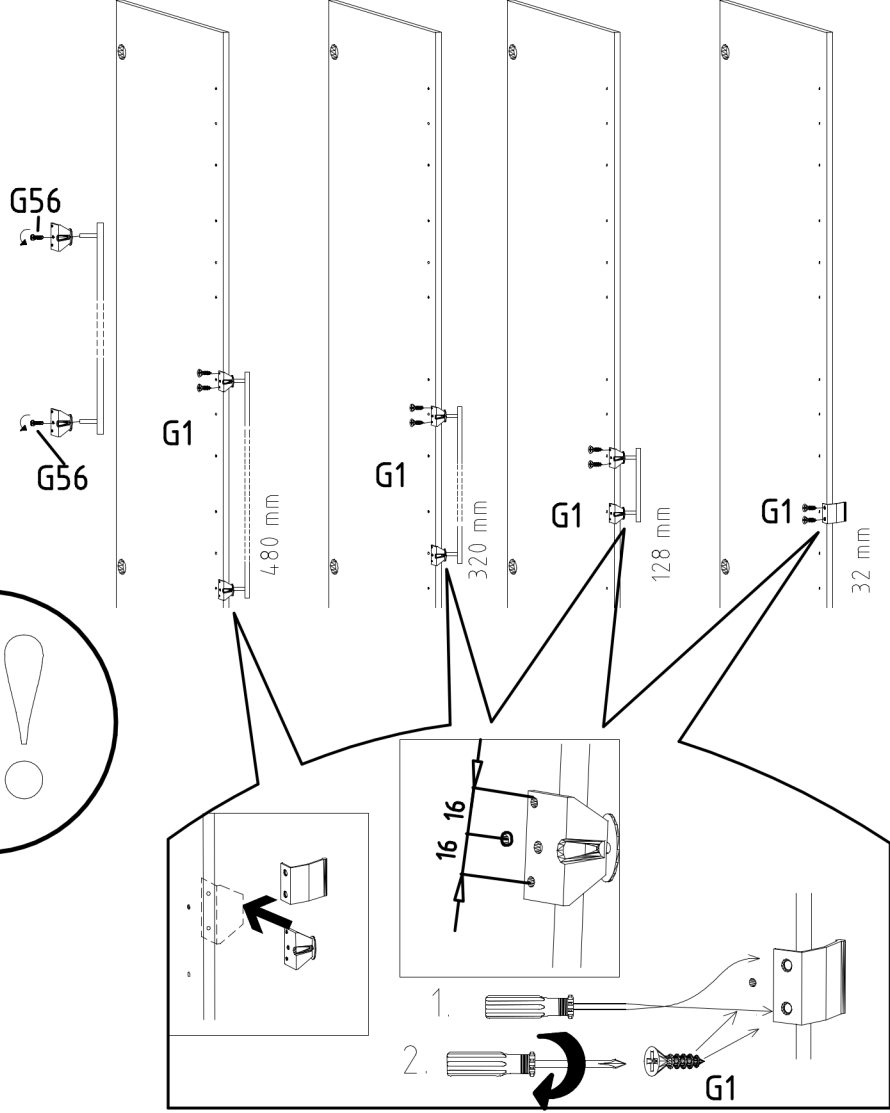
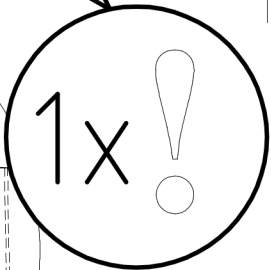
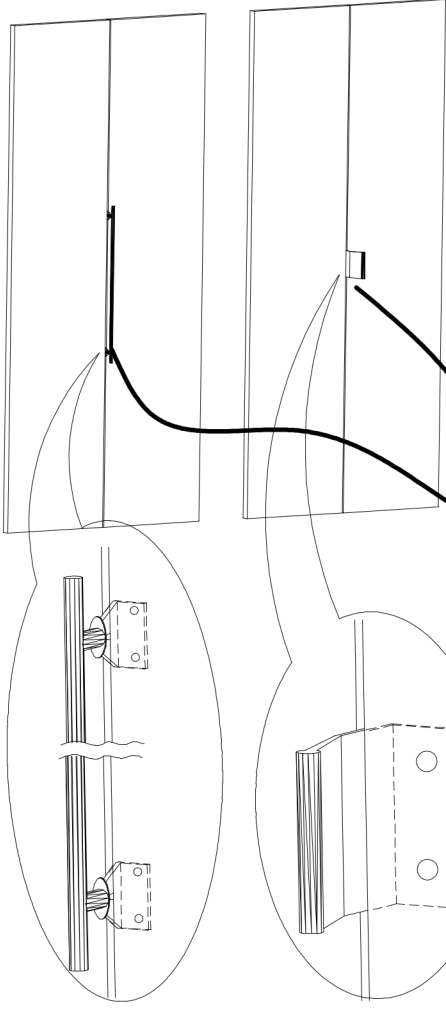

<b>SP27</b>
4 X 27mm
122620
4,0x22
<b>G49</b>
122 609



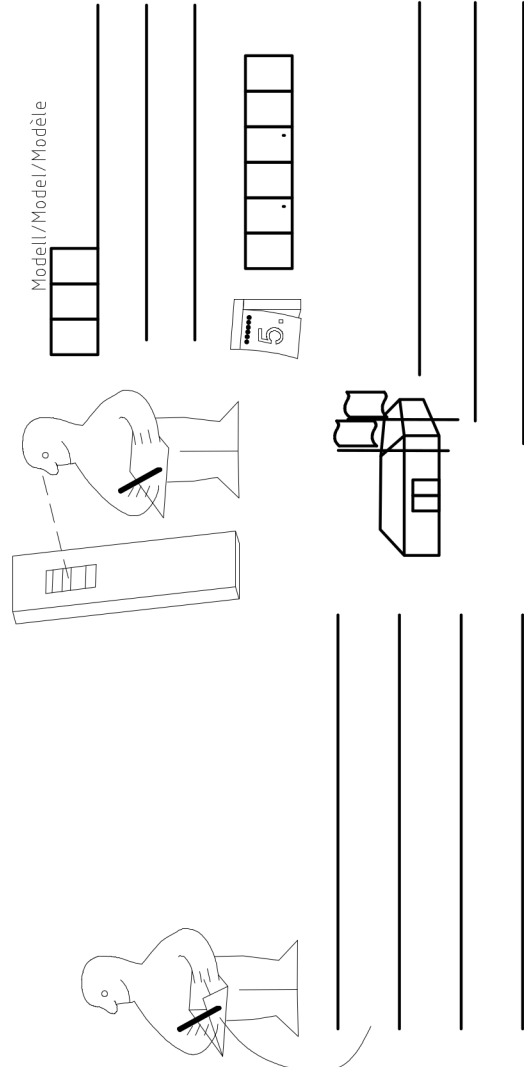
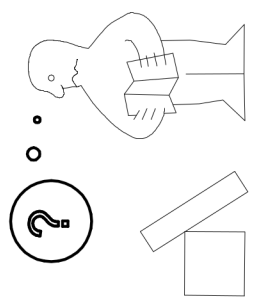
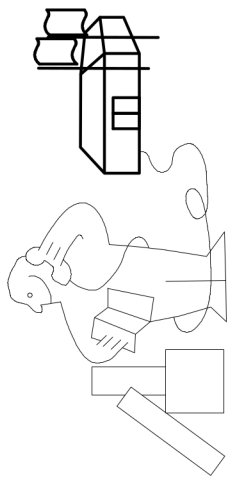
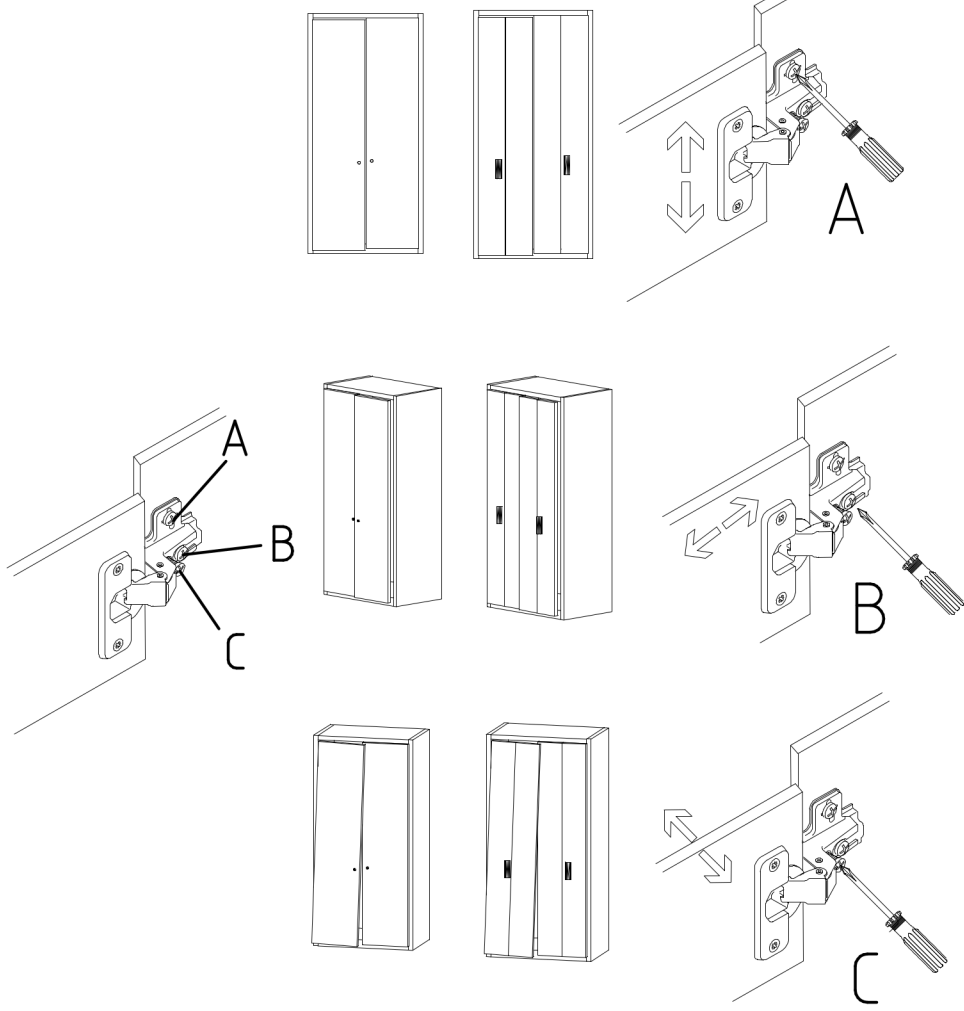

Modell/Model/Modèle

\_\_\_\_\_

\_\_\_\_\_

\_\_\_\_\_

\_\_\_\_\_

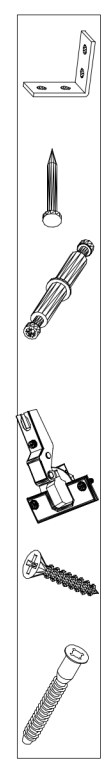

(121 370)	( G 1 )	(4x)				