

980231

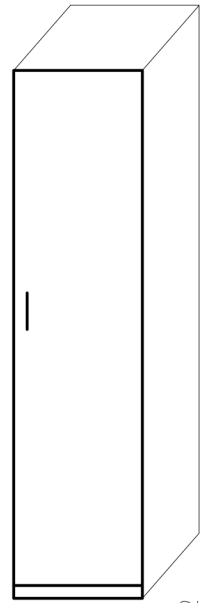

SHS 43 ZB

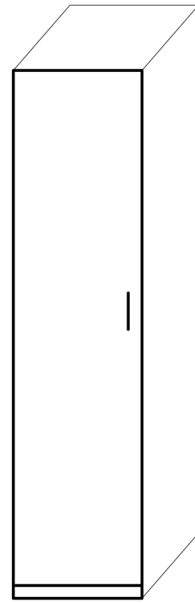

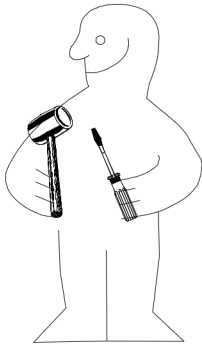
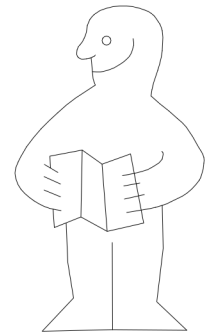
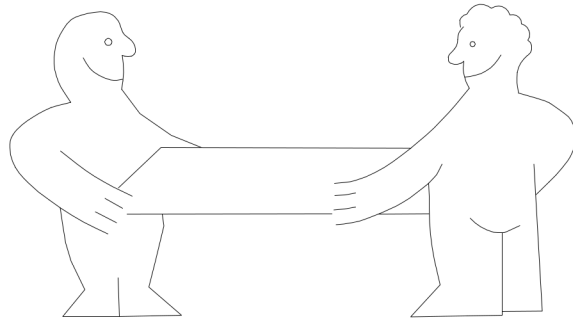
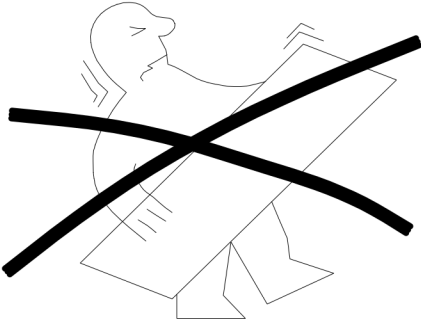

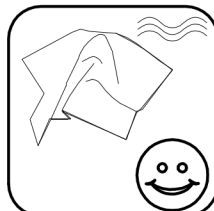
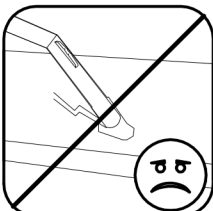
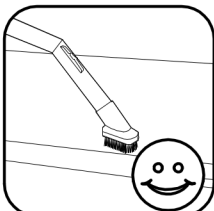
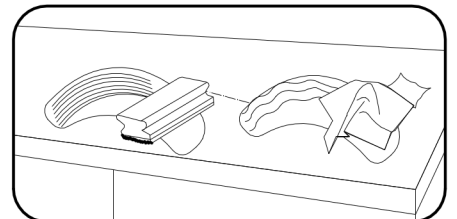
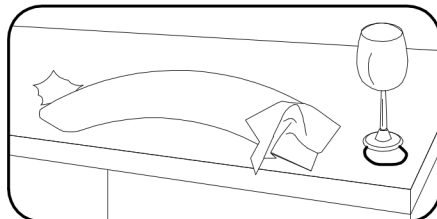
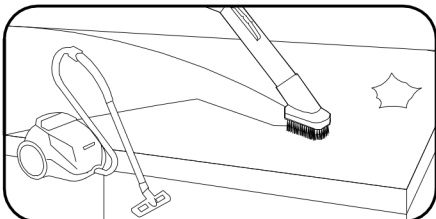
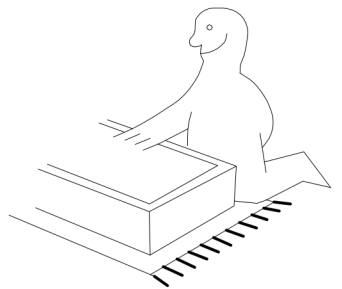
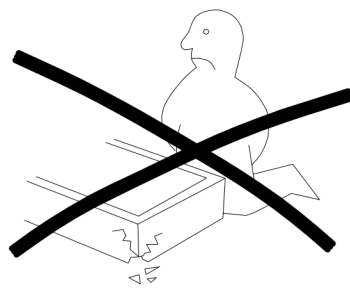
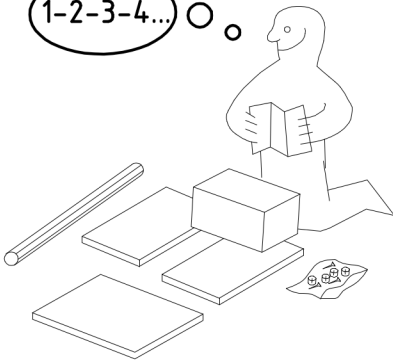
1-2-3-4... ○ ○







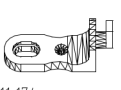
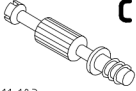

980231

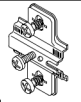
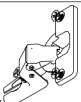
06.04.16 / -

04 16 | 1/8

 111 102	A	8x
 111 610	L7	12x
 111 174	J1	4x
 111 103	C	8x

 112 268	M	4x
 112 267	N	4x
 M6 x 11 mm 121 181	T6	4x
 3,5 x 15 mm 121 370	G1	4x

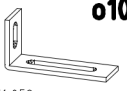
 111 618	D20	1x
 6 X 60 mm 121123	G16	1x
 4 X 15mm 121 120	SP15	1x
 111 052	o10	1x

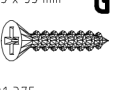
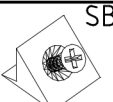
 3,5 x 35 mm 121 375	G14	4x
 121 375	SBV	4x

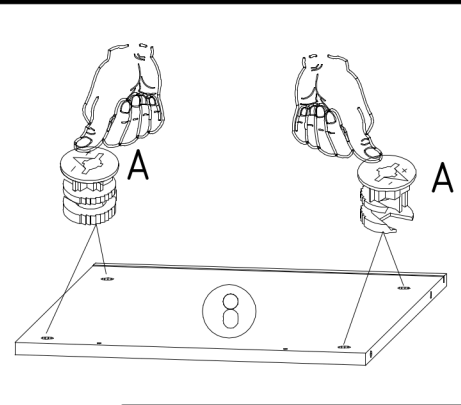
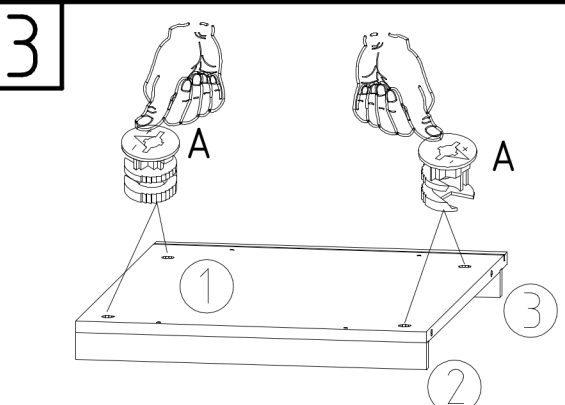
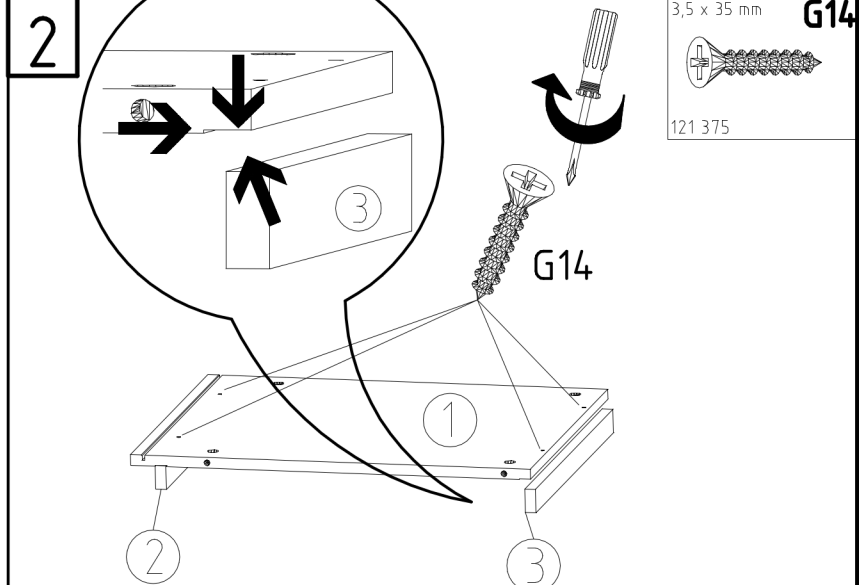
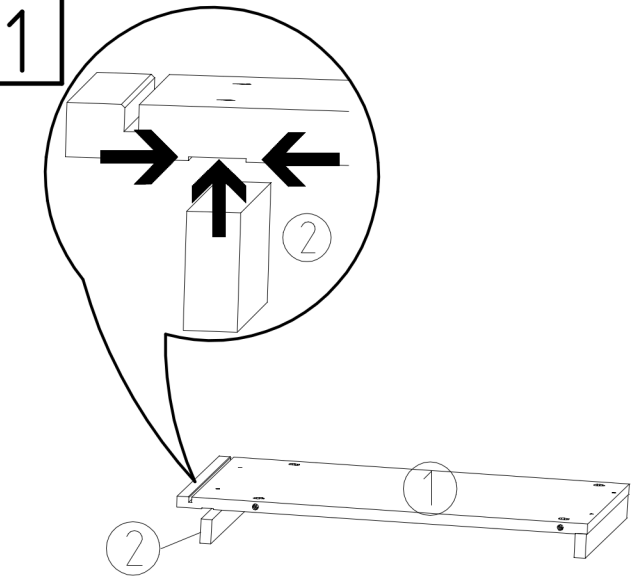
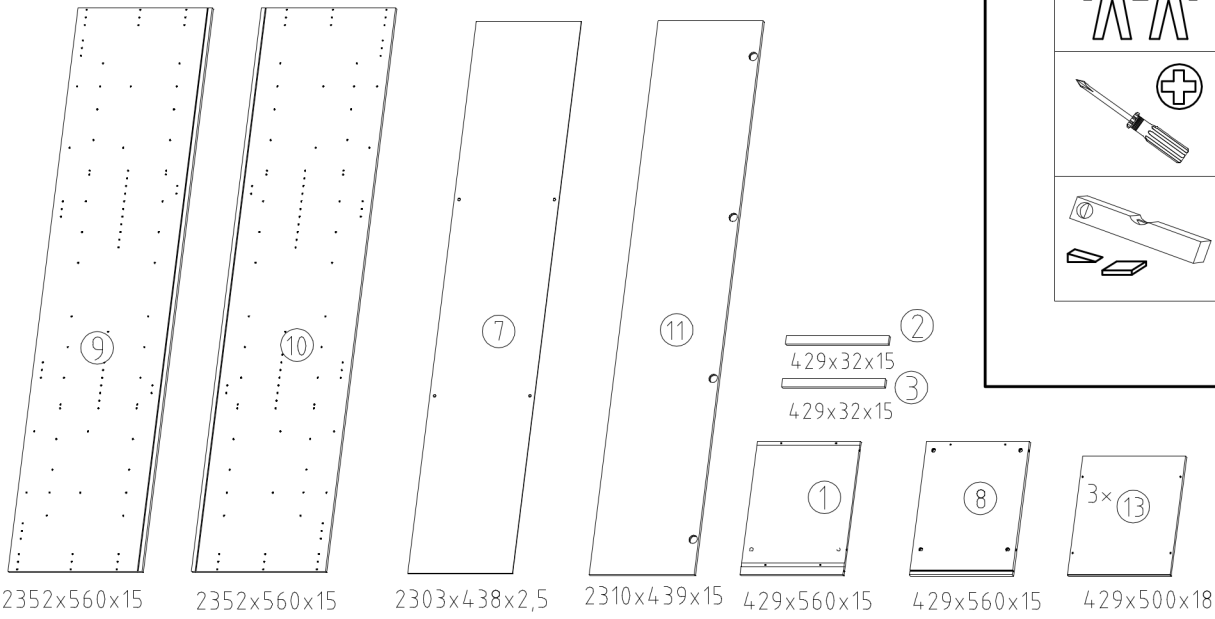
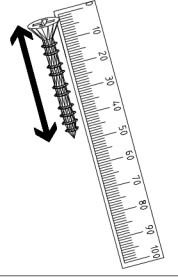
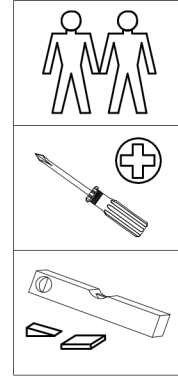
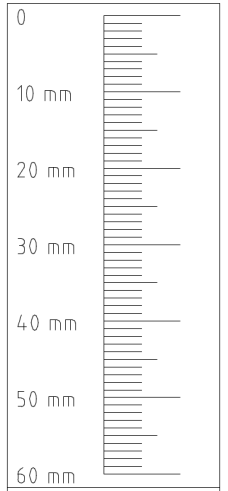

4

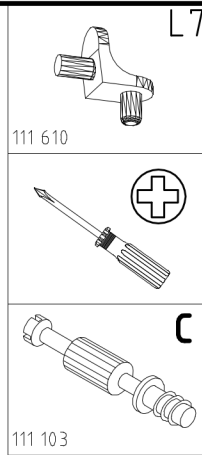
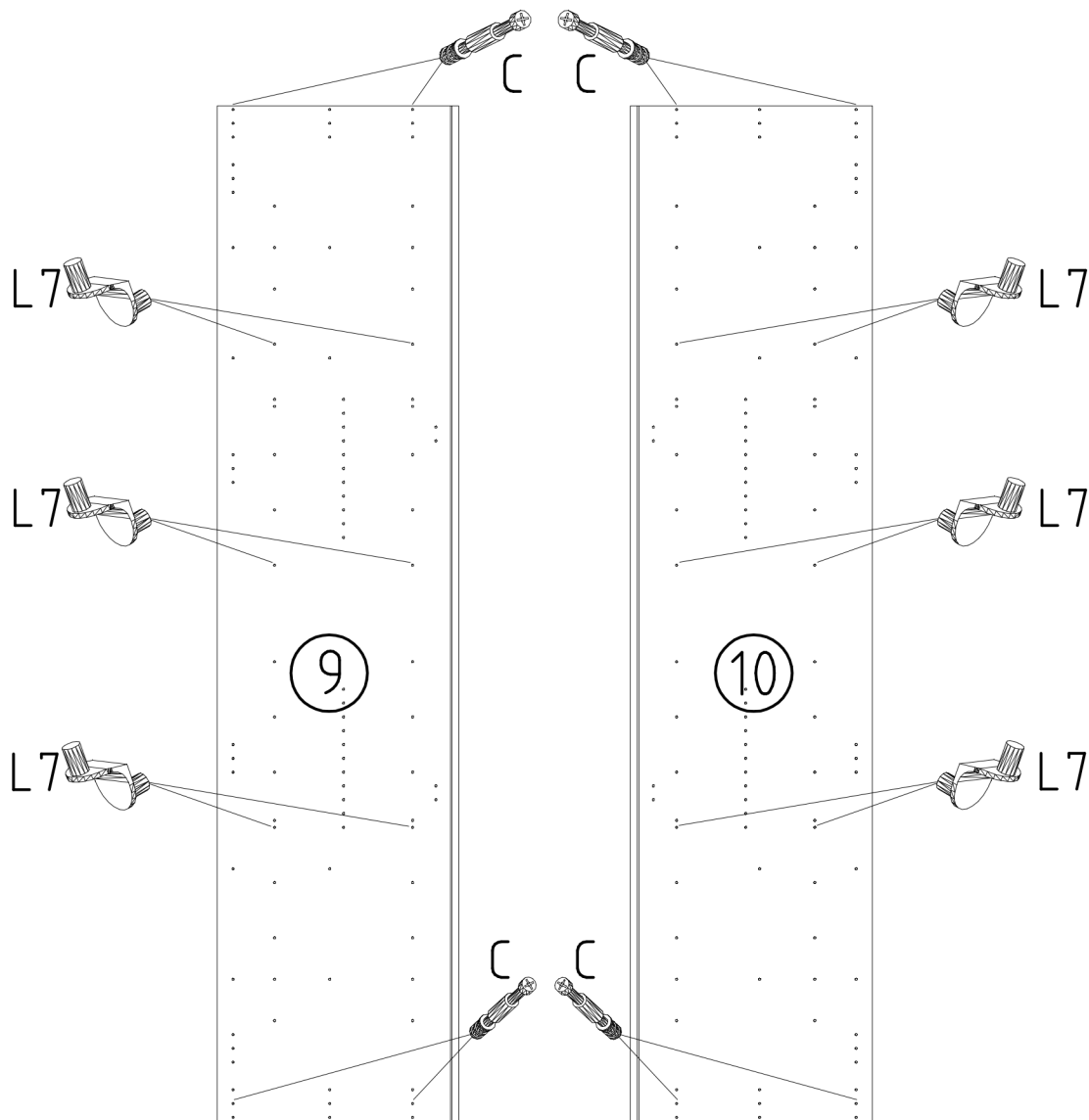

5

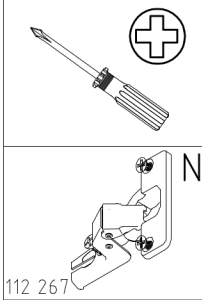
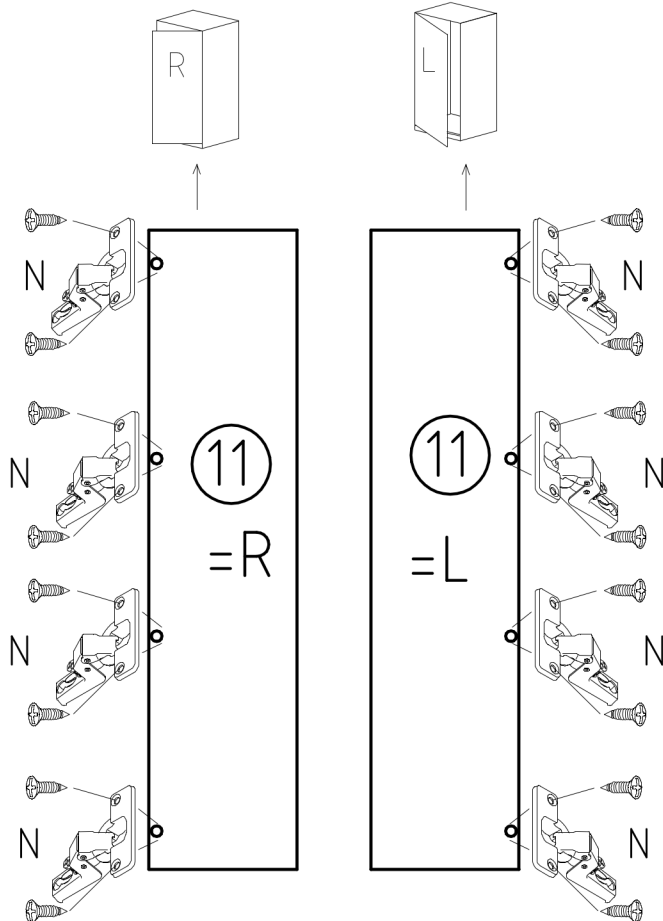

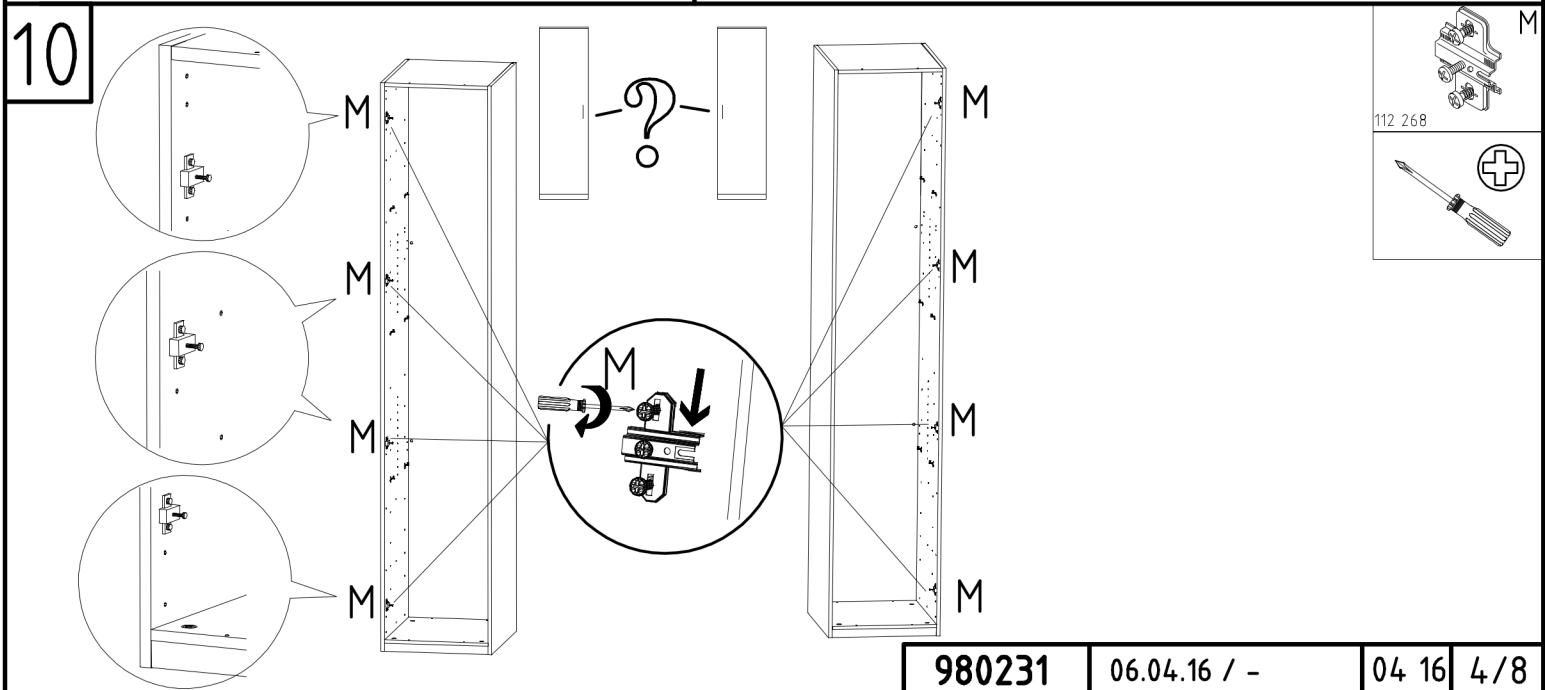
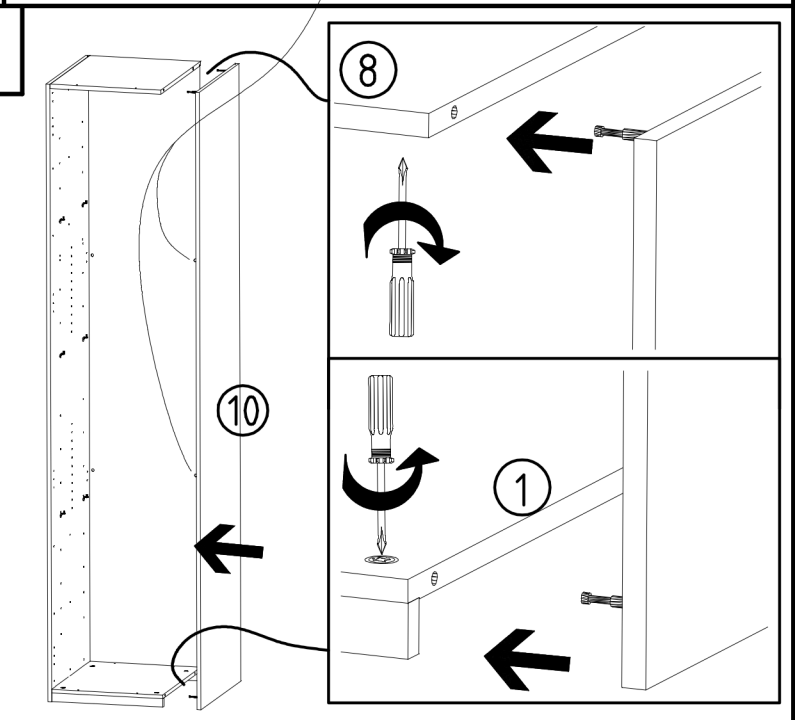
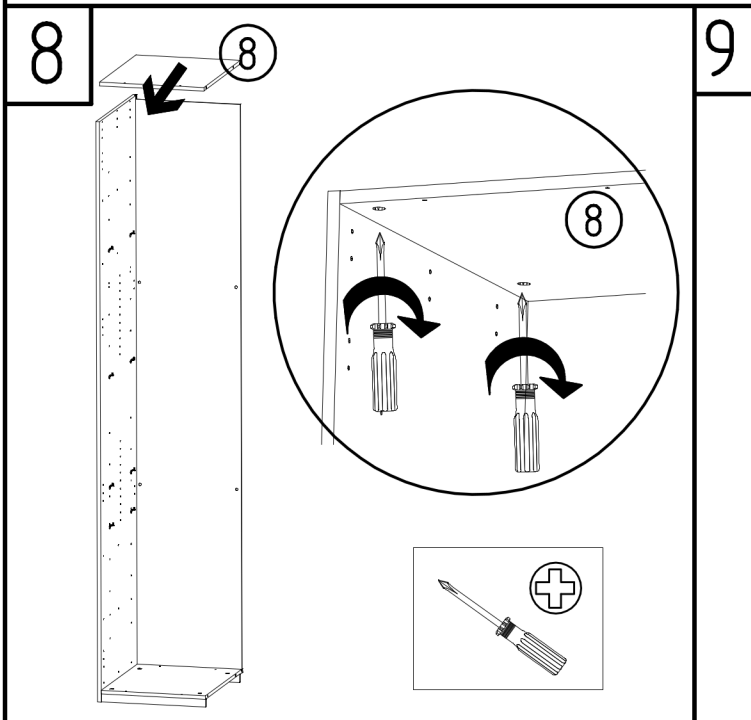
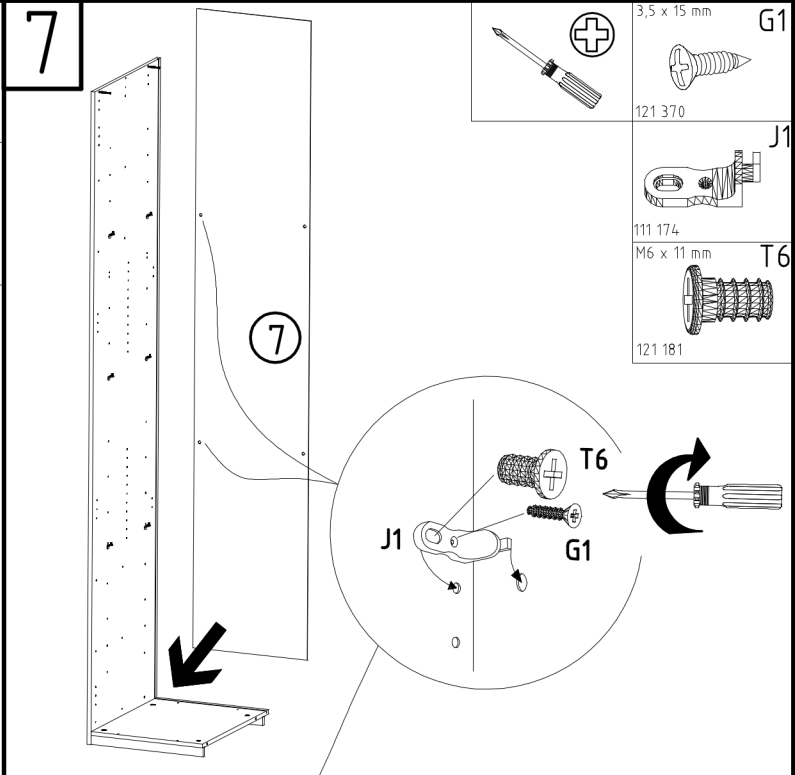
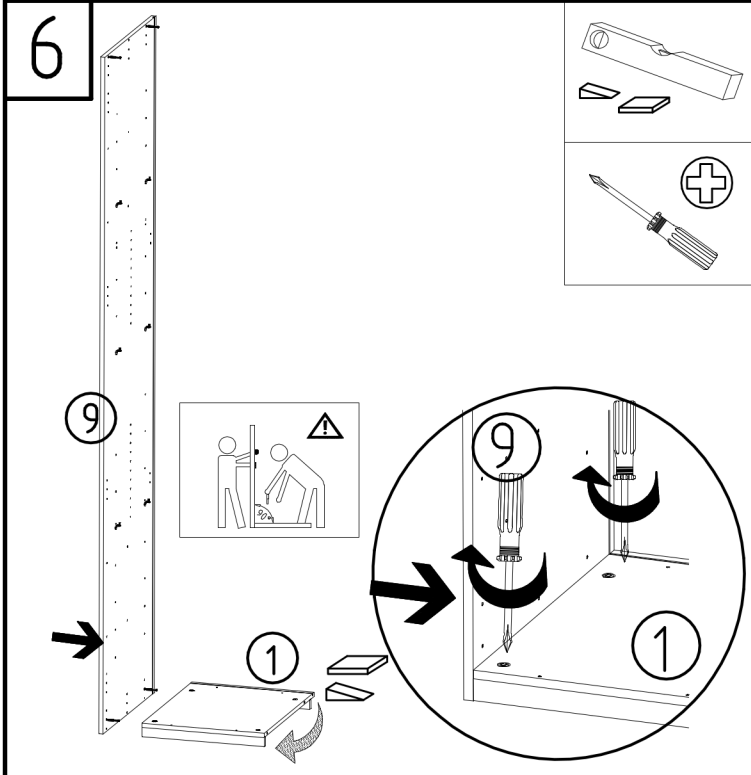

11

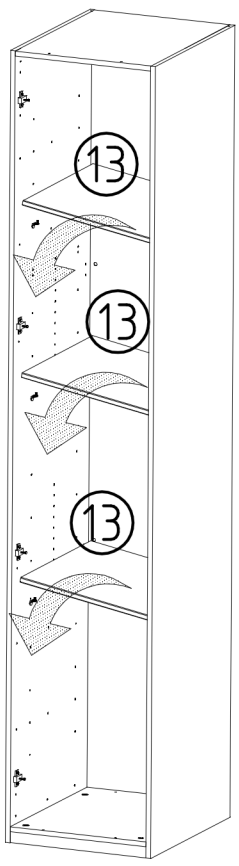

12

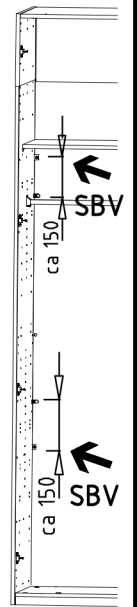
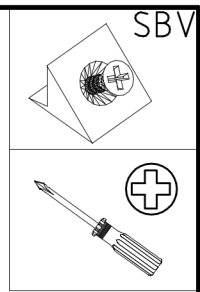
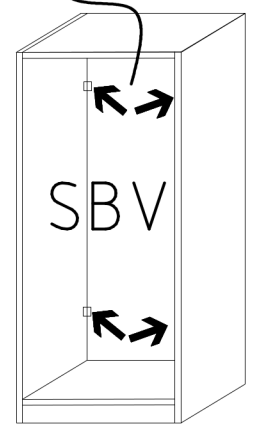
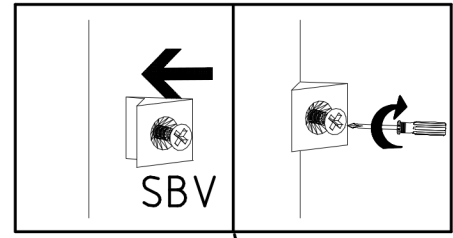

13

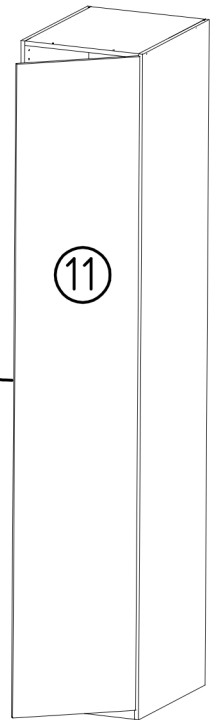
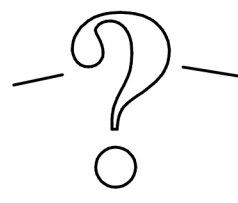
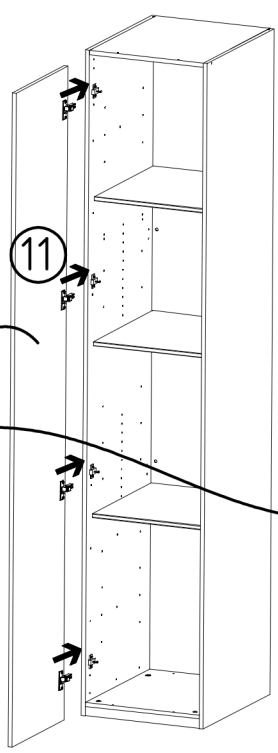
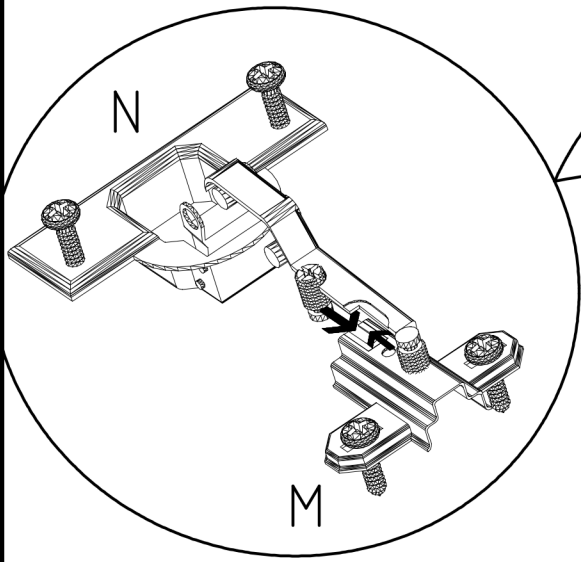
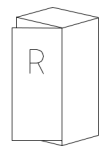
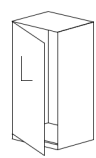
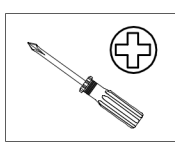

14

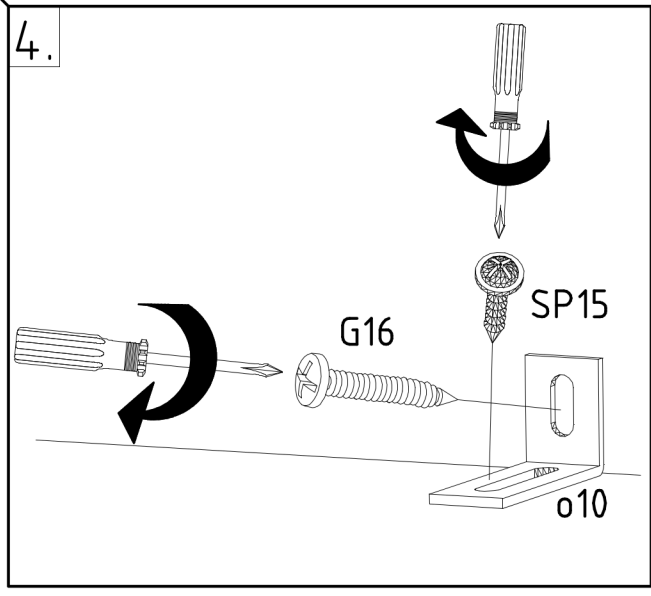
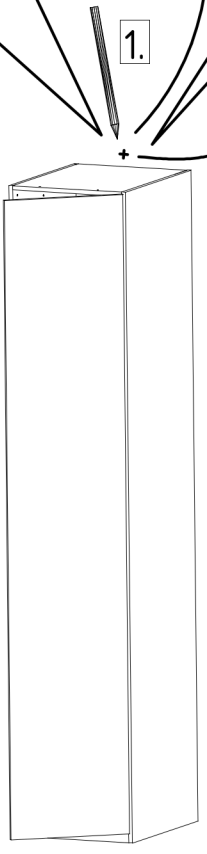
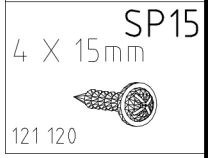
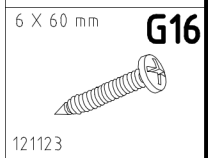
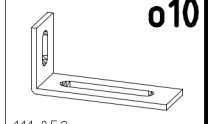
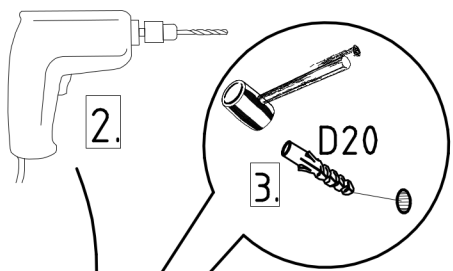
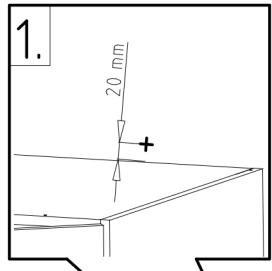
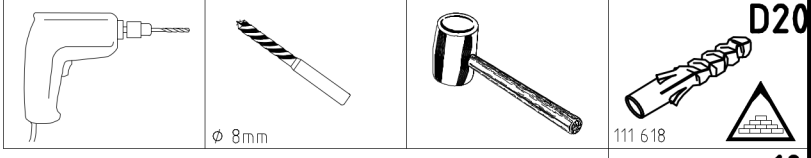
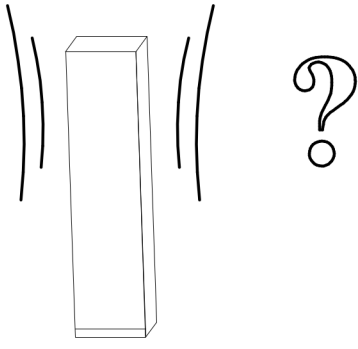

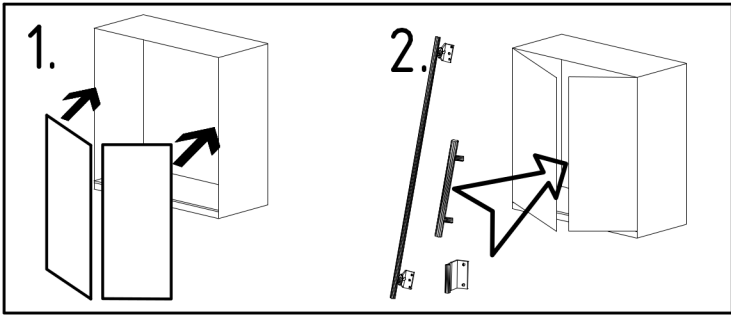

3,5 x 15 mm 121 370	G1	4,0 x 12 mm 122 625	G56
------------------------	----	------------------------	-----

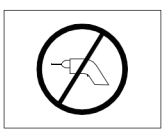
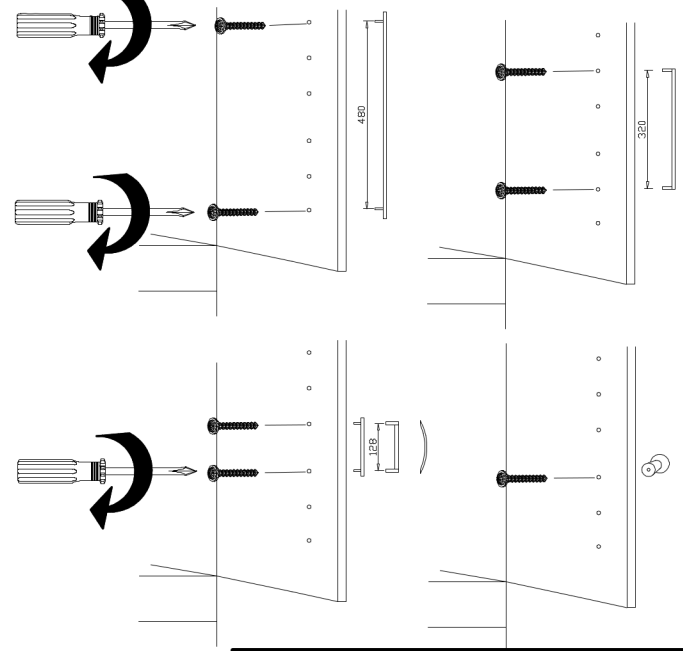
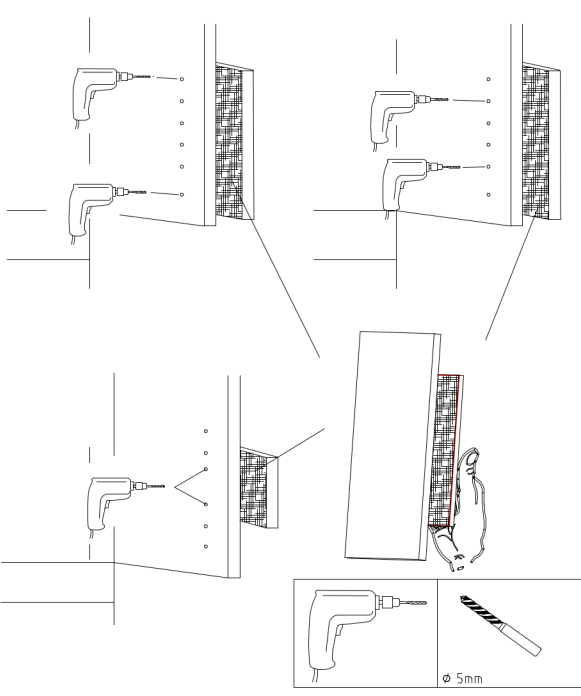
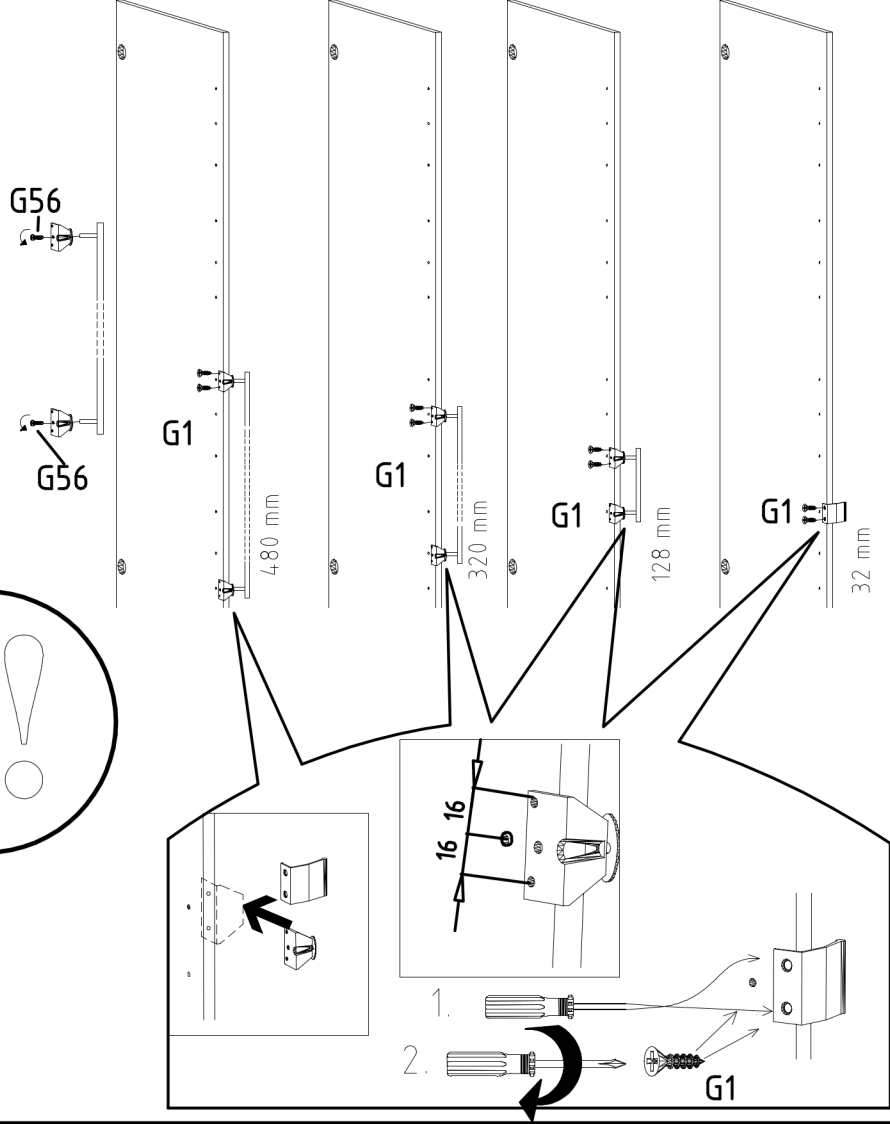
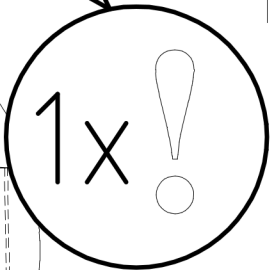
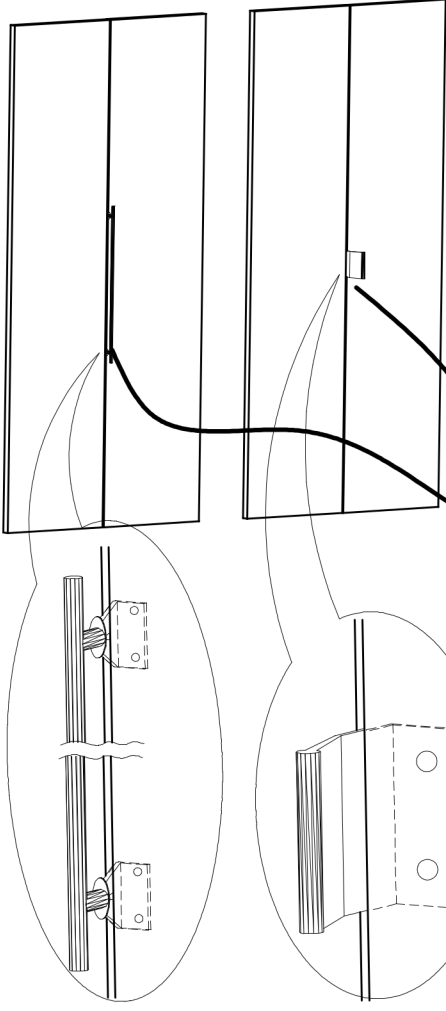

	SP27
4 X 27mm	
122620	
4,0x22	G49
122 609	

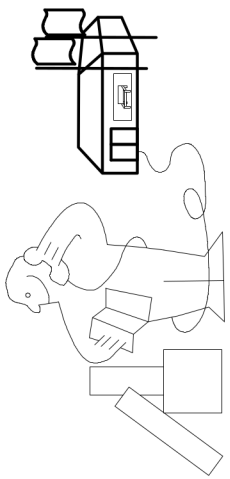
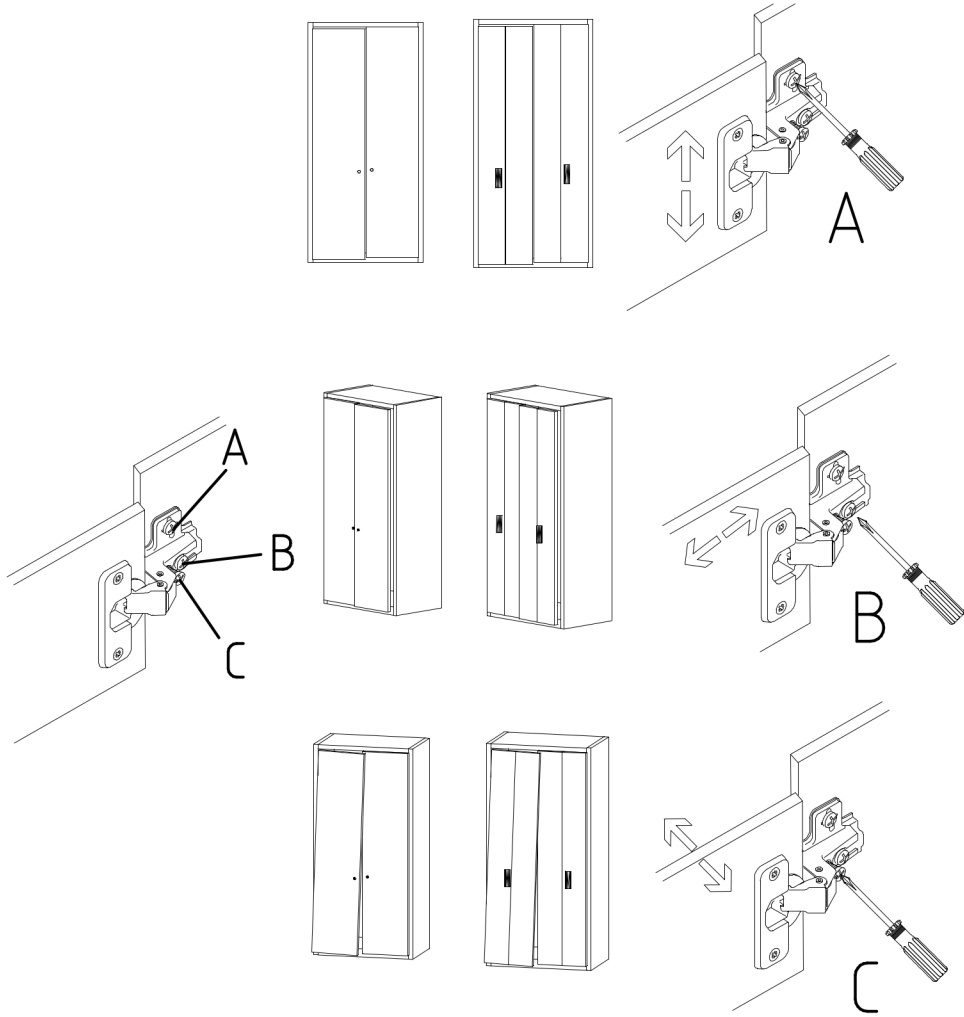

Modell/Model/Modèle

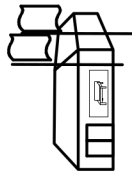
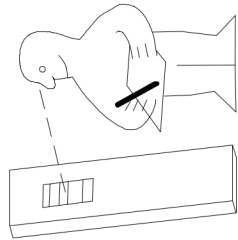

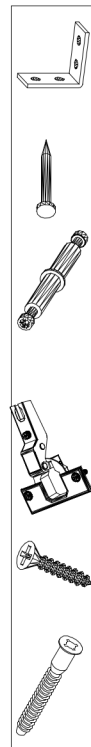
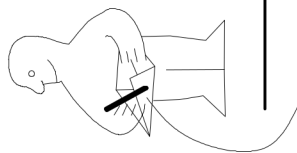
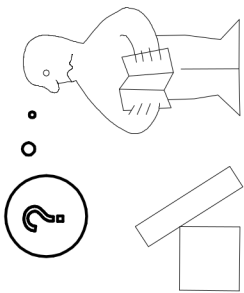

(121 370)	(G 1)	(4x)				