

980336

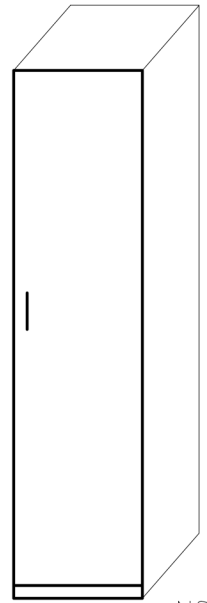

NSP 43 ZB

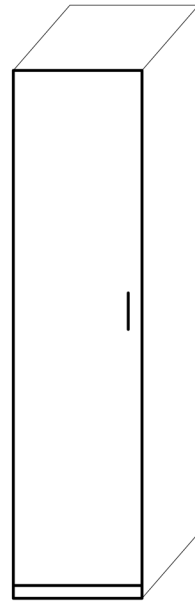

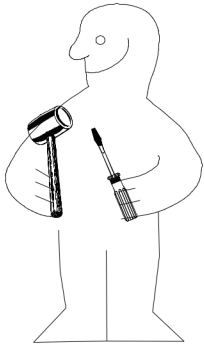
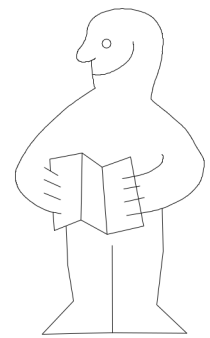
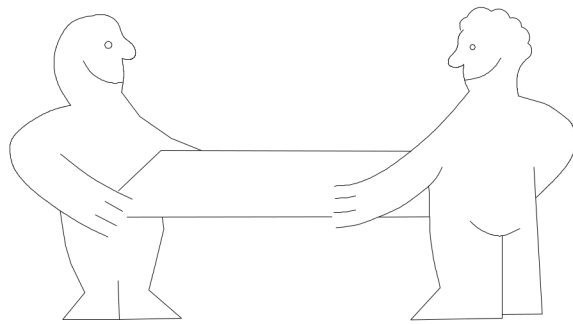
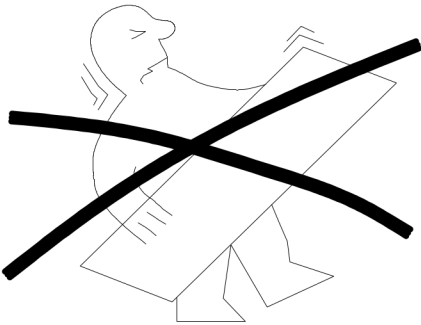

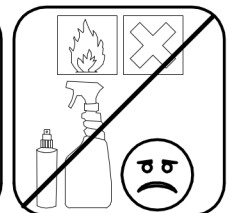
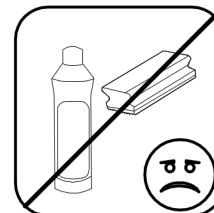
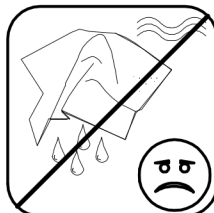
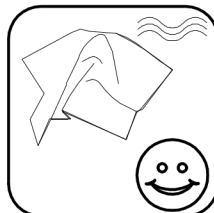
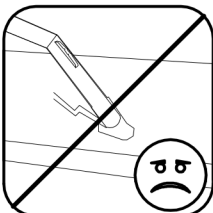
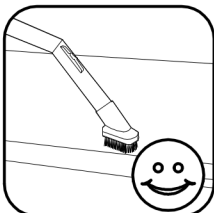
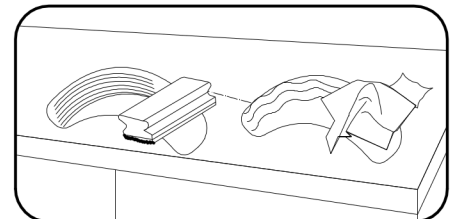
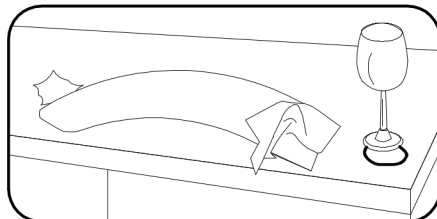
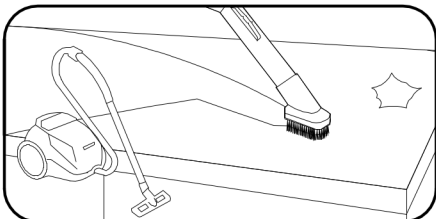
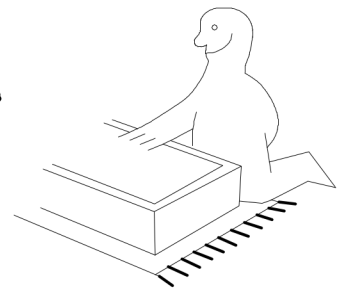
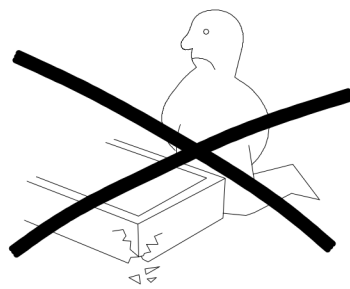
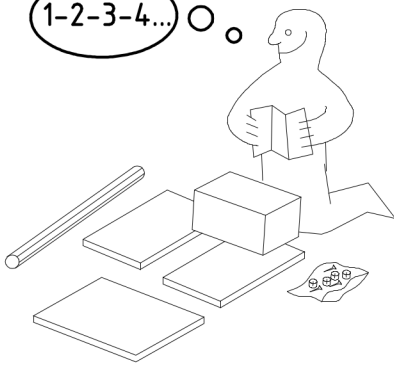
1-2-3-4... ○ ○







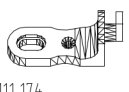
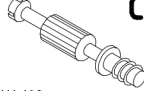

980336

06.04.16 / -

04 16 | 1/8

 111 102	A 8x
 111 610	L7 12x
 111 174	J1 2x
 111 103	C 8x

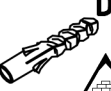
 112 268	M 3x
 112 267	N 3x
 M6 x 11 mm	T6 2x
 3,5 x 15 mm	G1 2x

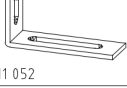
 111 618	D20 1x
 6 X 60 mm	G16 1x
 4 X 15 mm	SP15 1x
 111 052	o10 1x

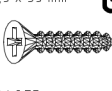
 3,5 x 35 mm	G14 4x
---	------------------

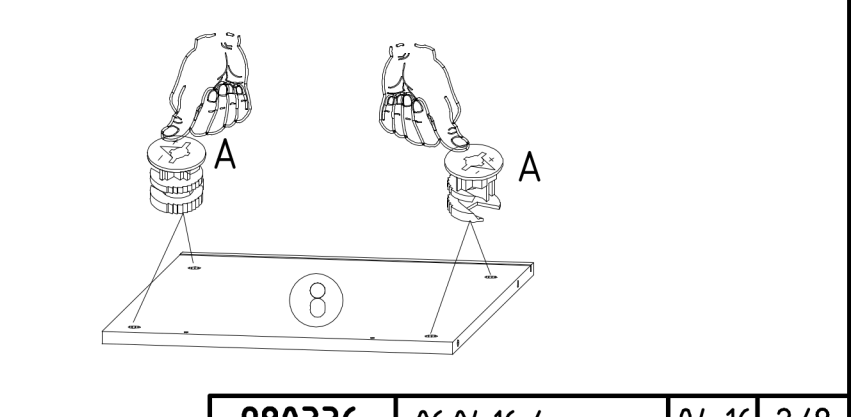
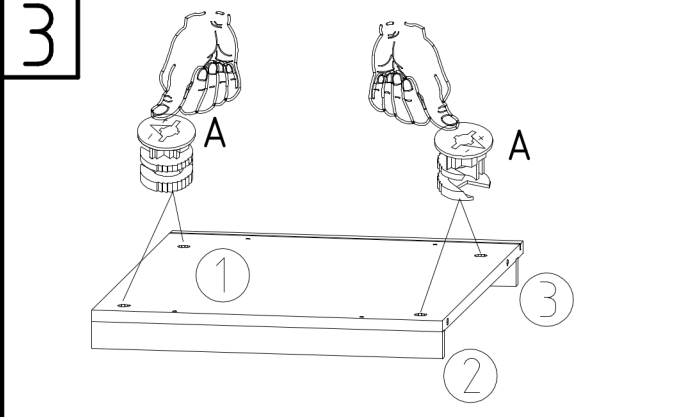
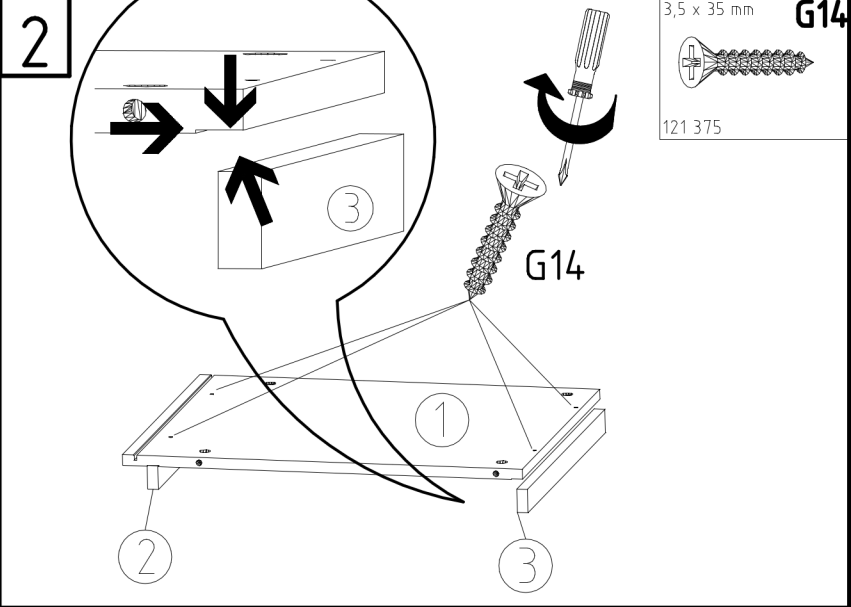
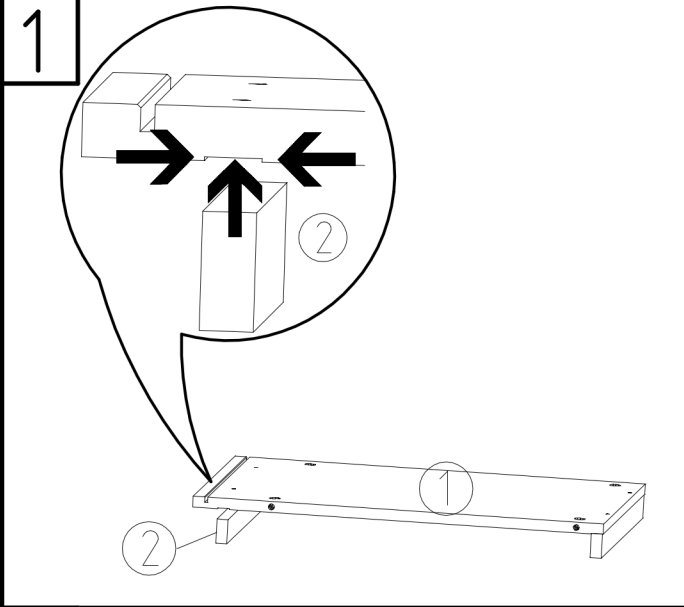
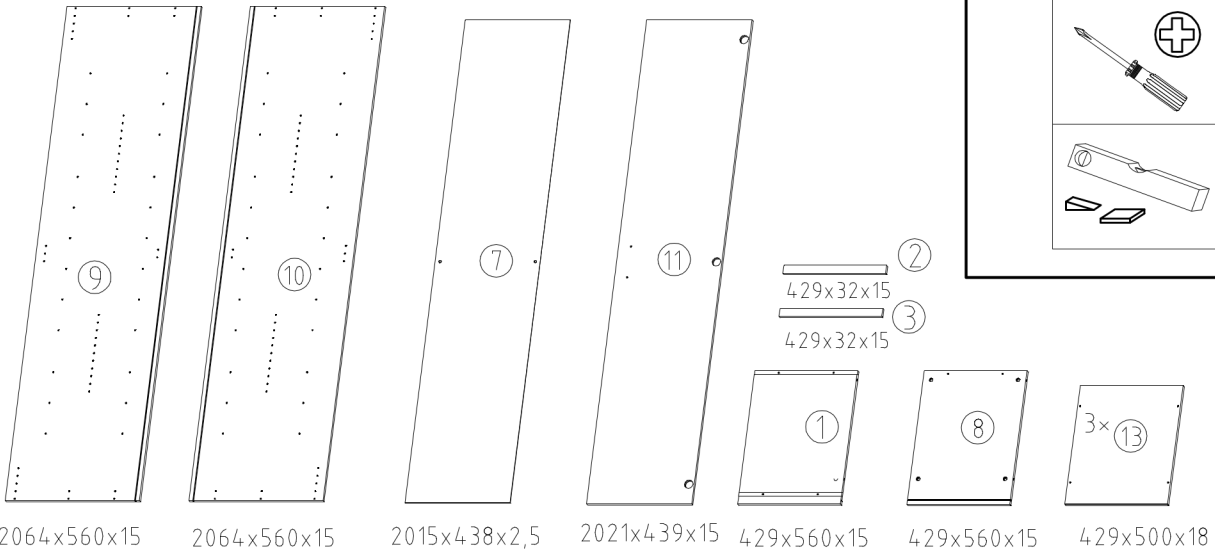
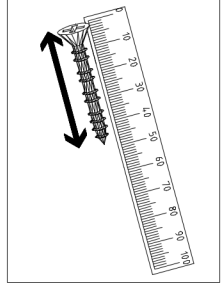
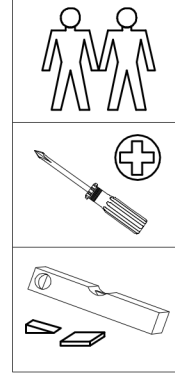
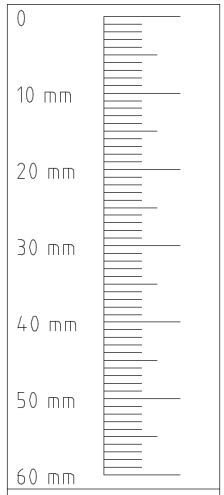

4

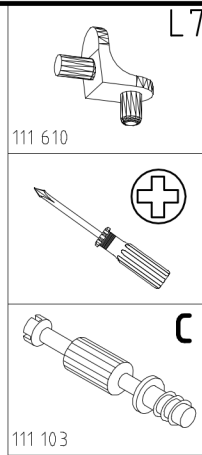
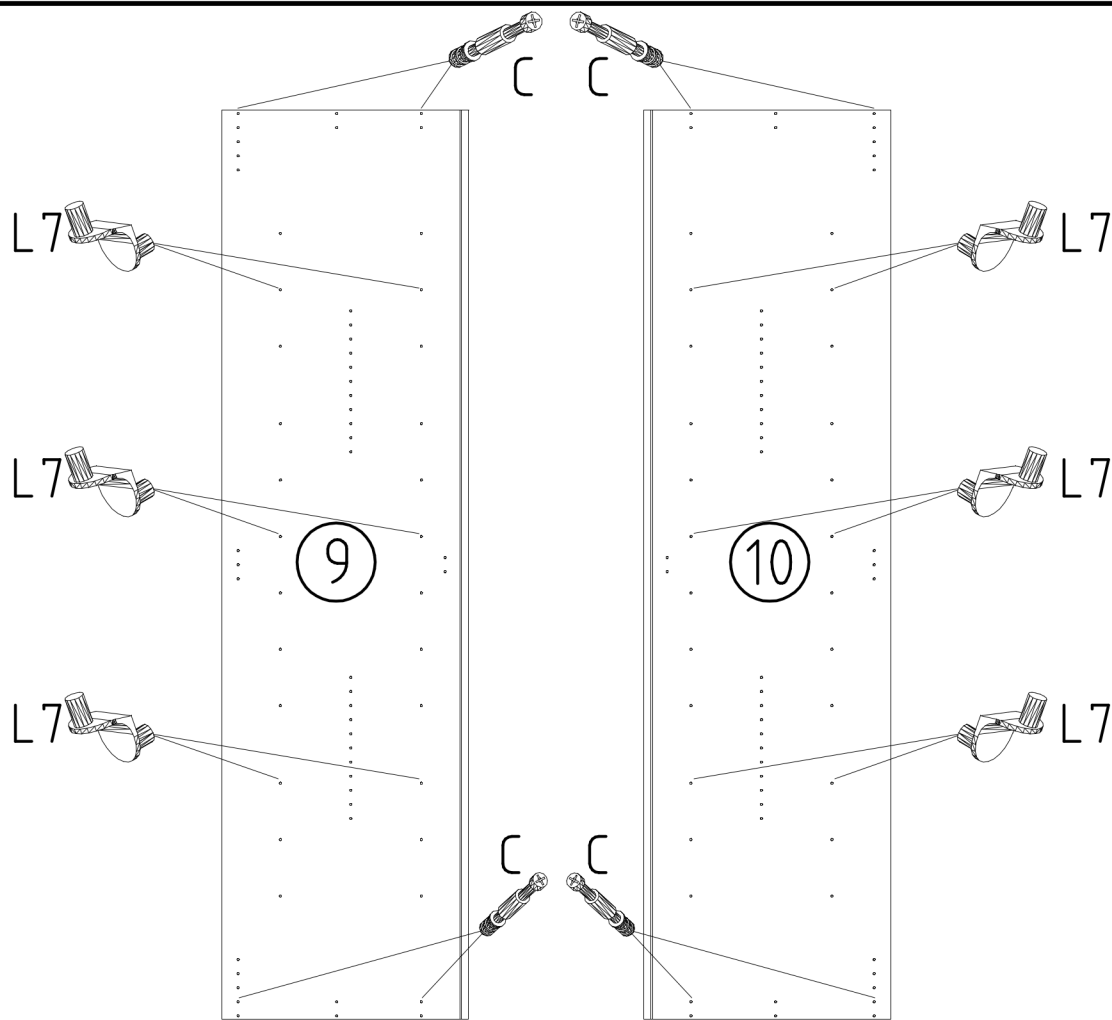

5

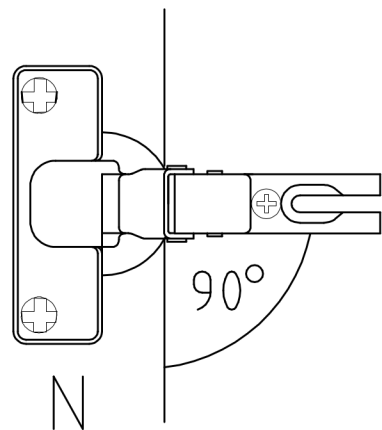
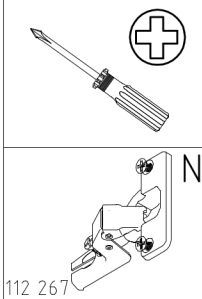
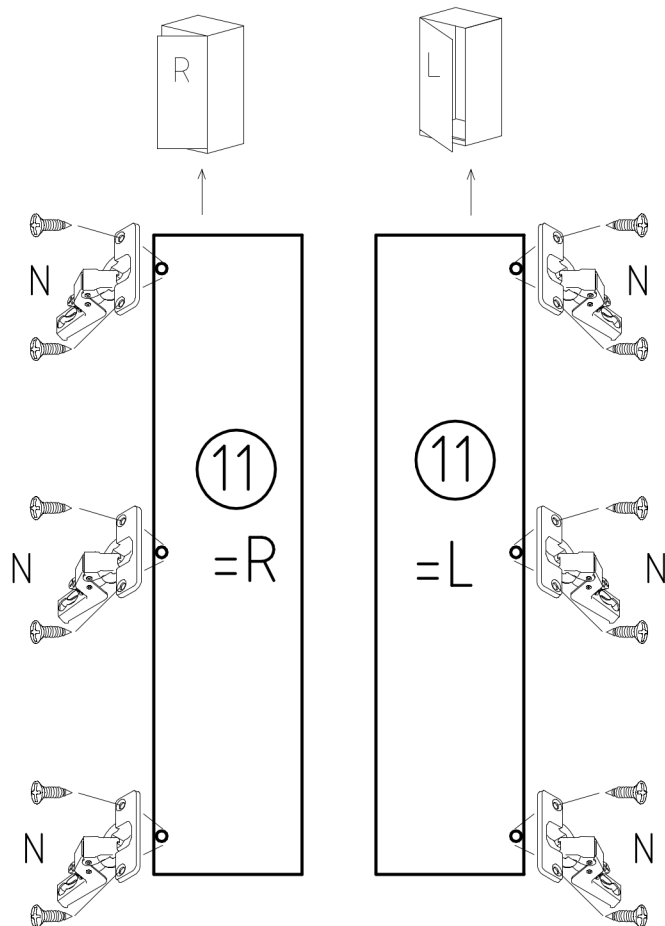

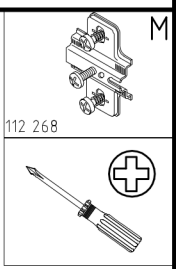
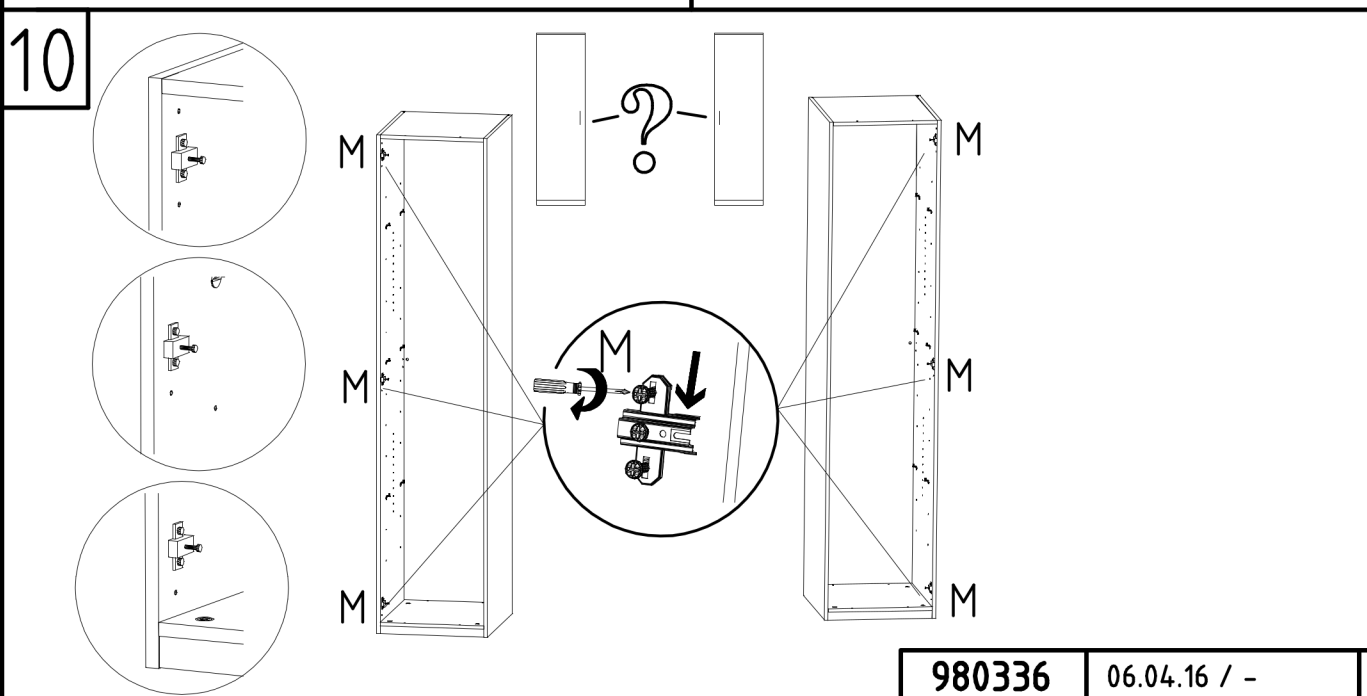
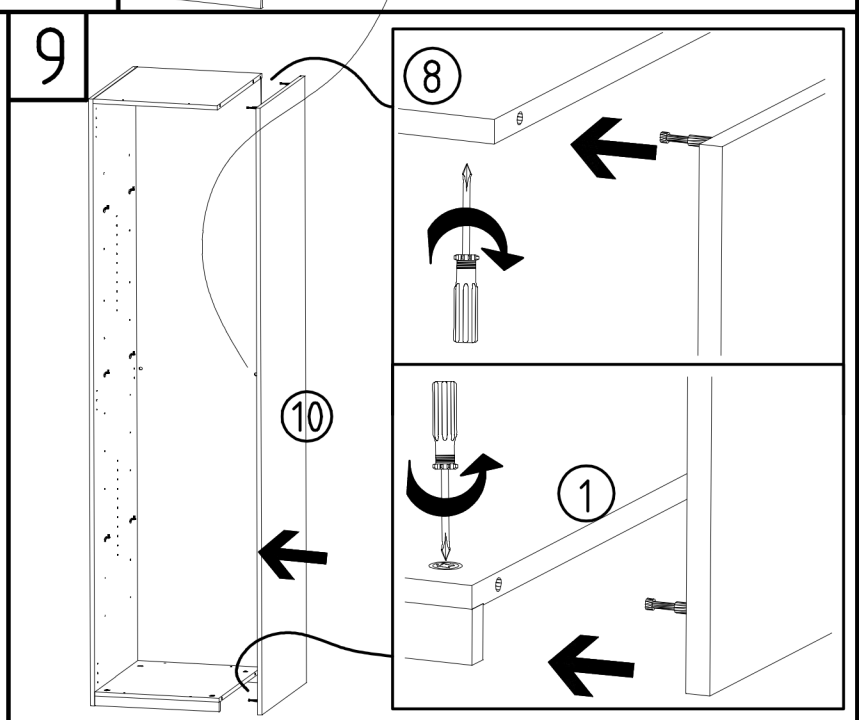
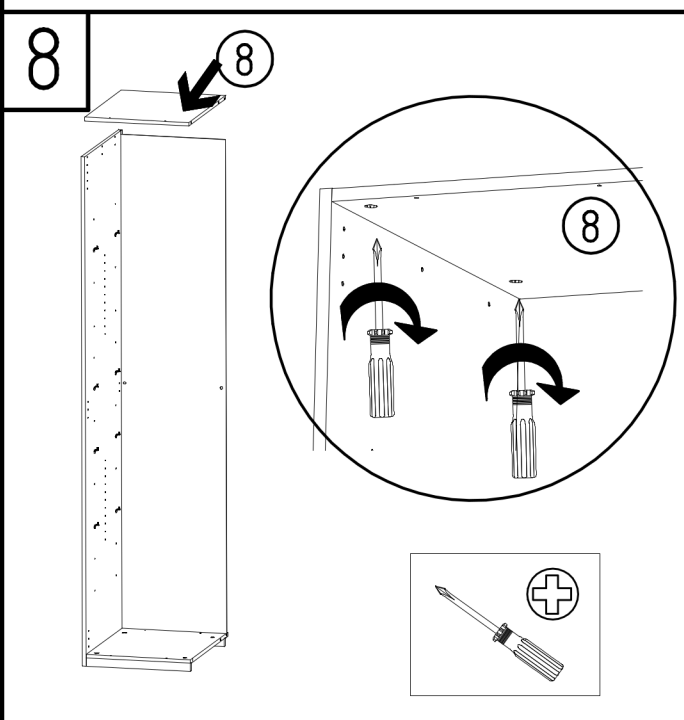
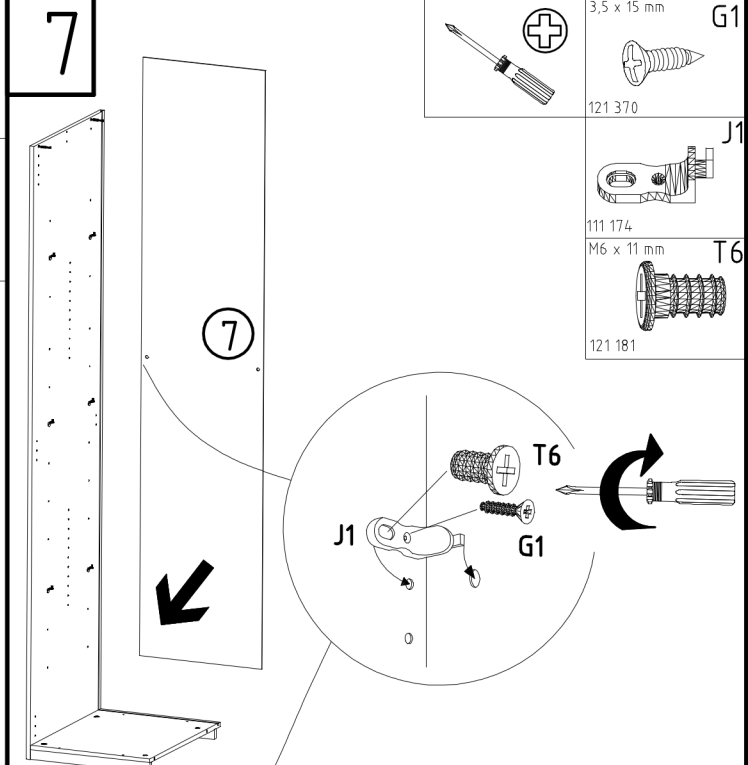
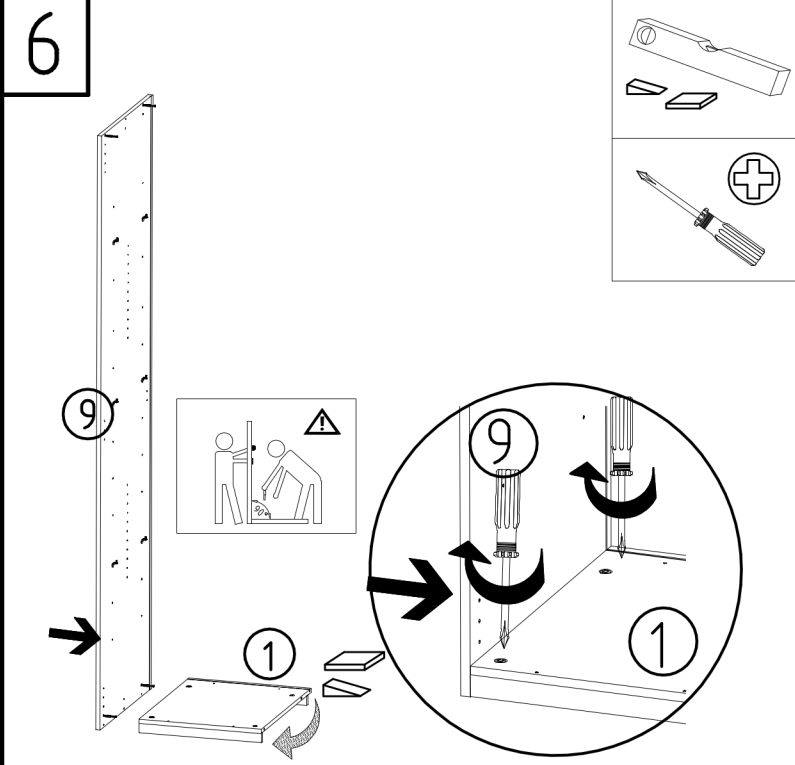

11

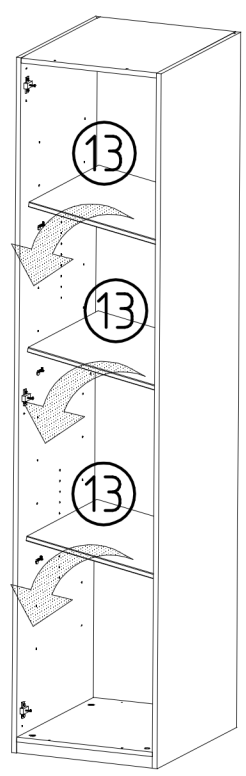

12

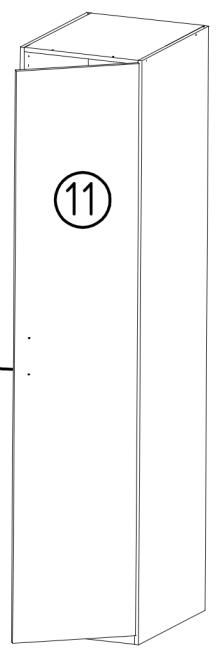
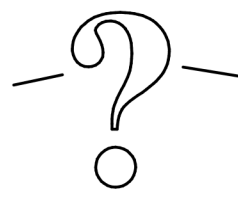
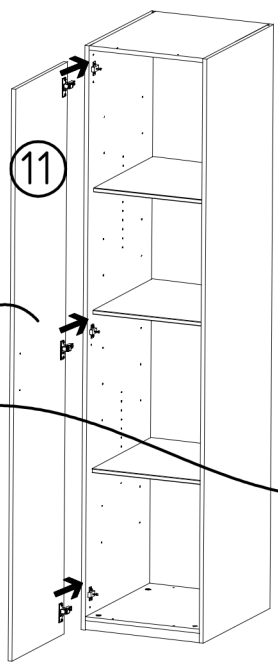
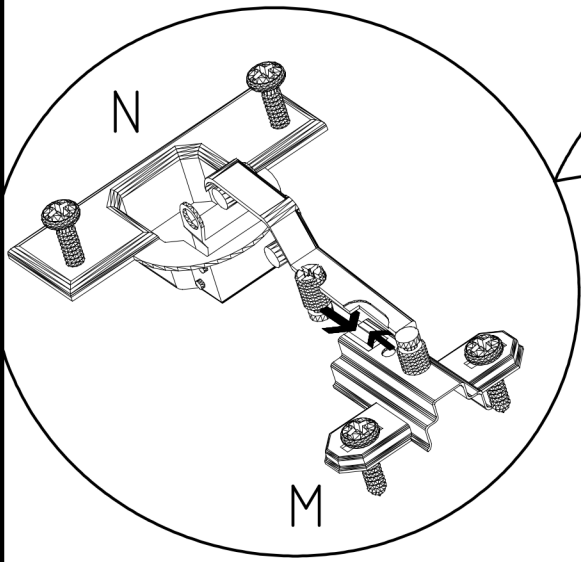
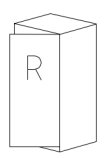
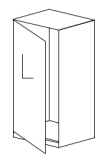
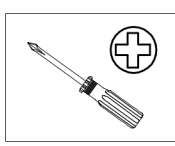

13

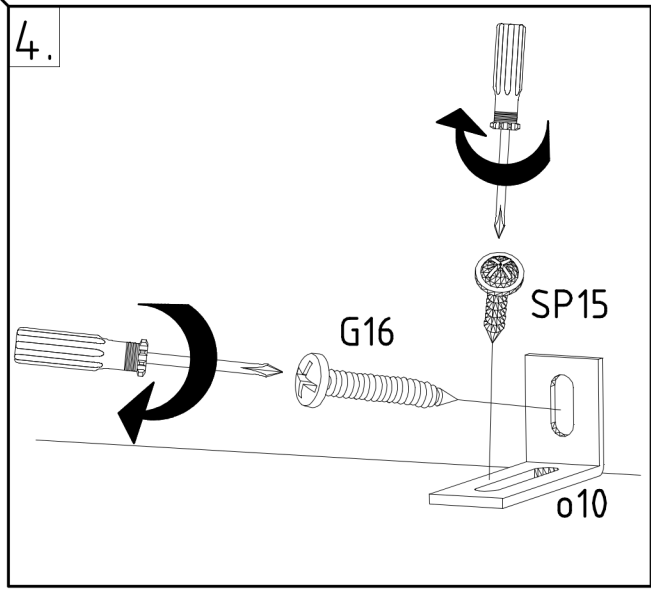
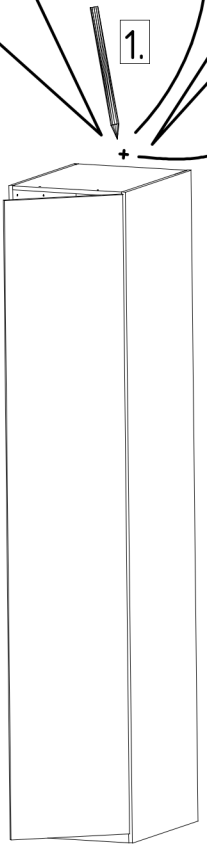
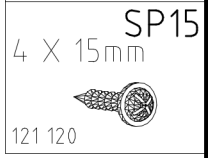
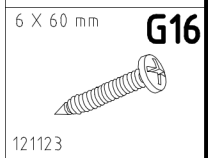
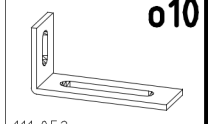
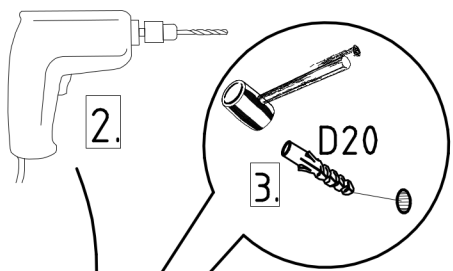
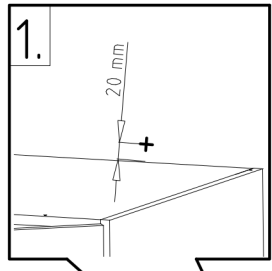
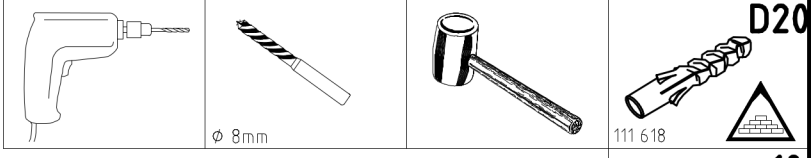
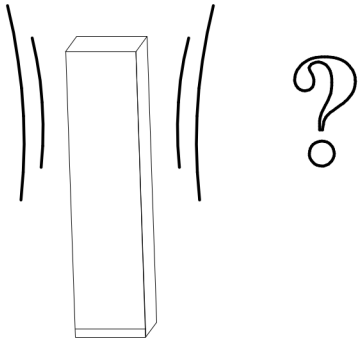

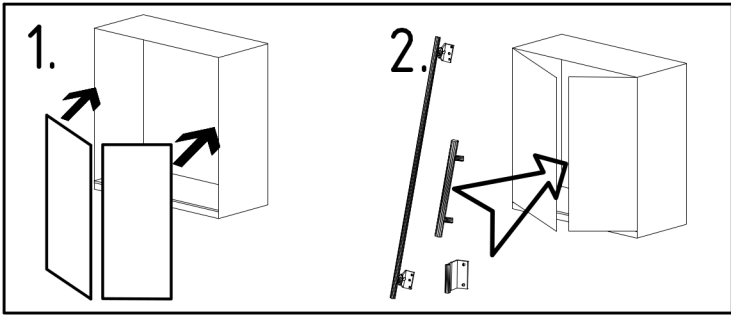

3,5 x 15 mm 121 370	G1	4,0 x 12 mm 122 625	G56
------------------------	----	------------------------	-----

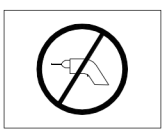
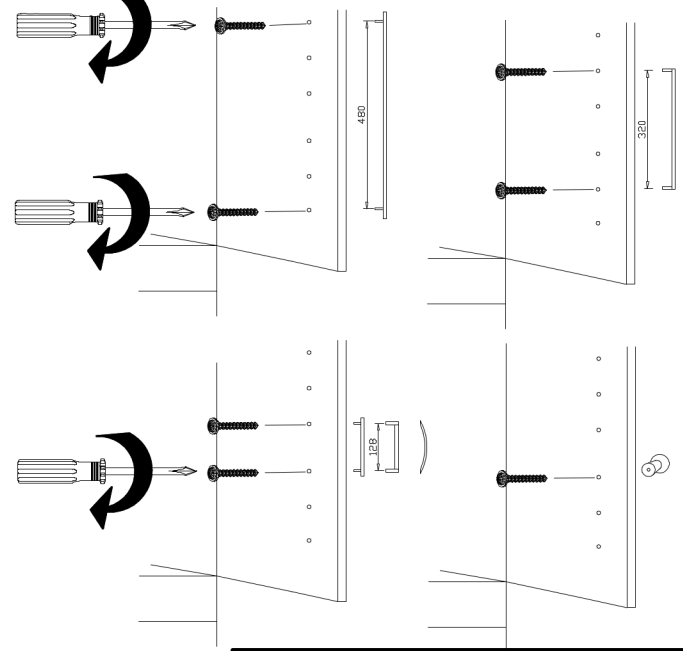
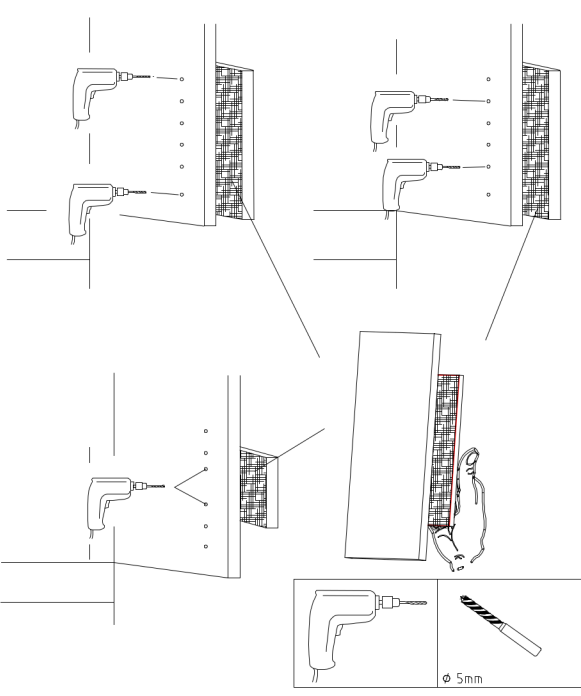
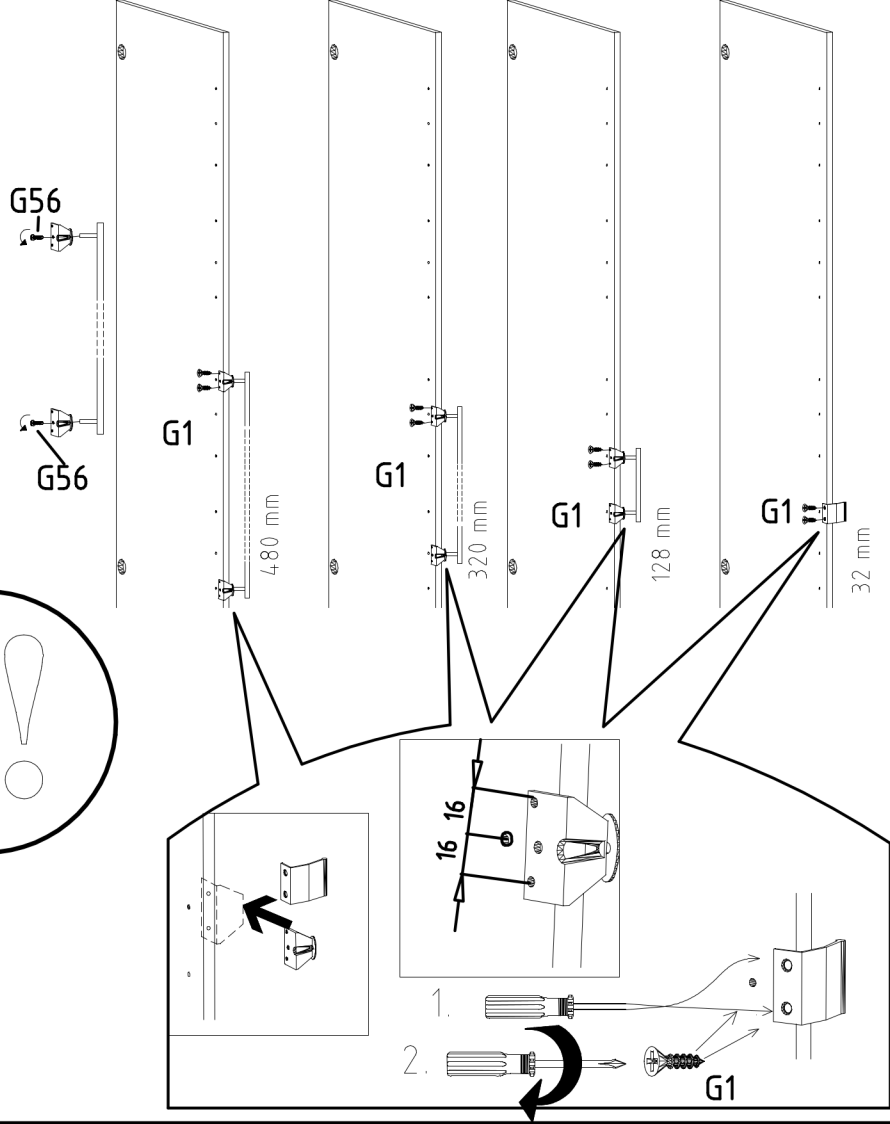
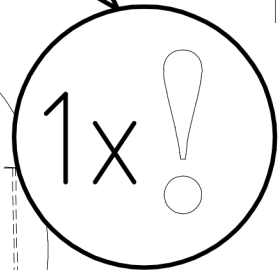
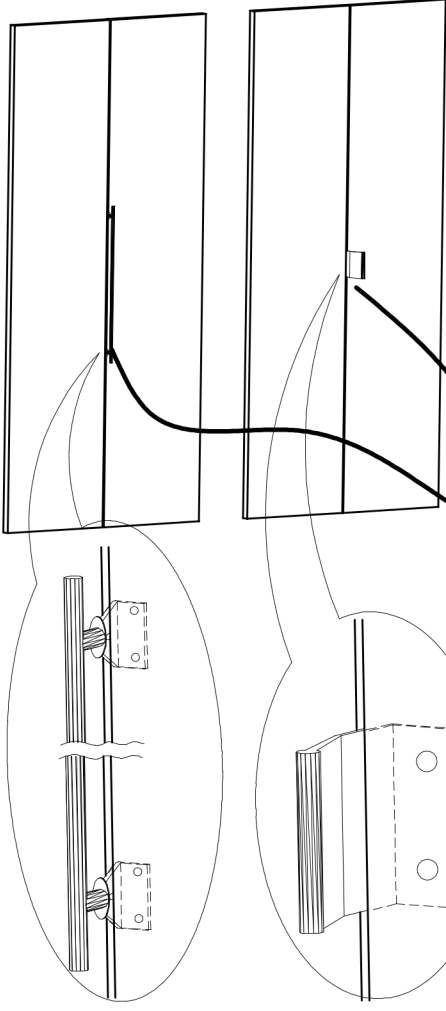

	SP27
4 X 27mm	
122620	
4,0x22	G49
122 609	

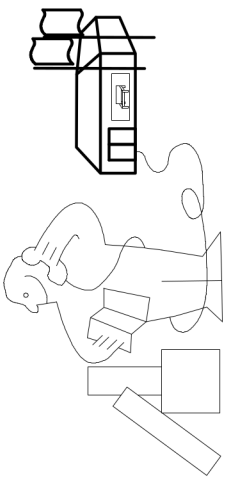
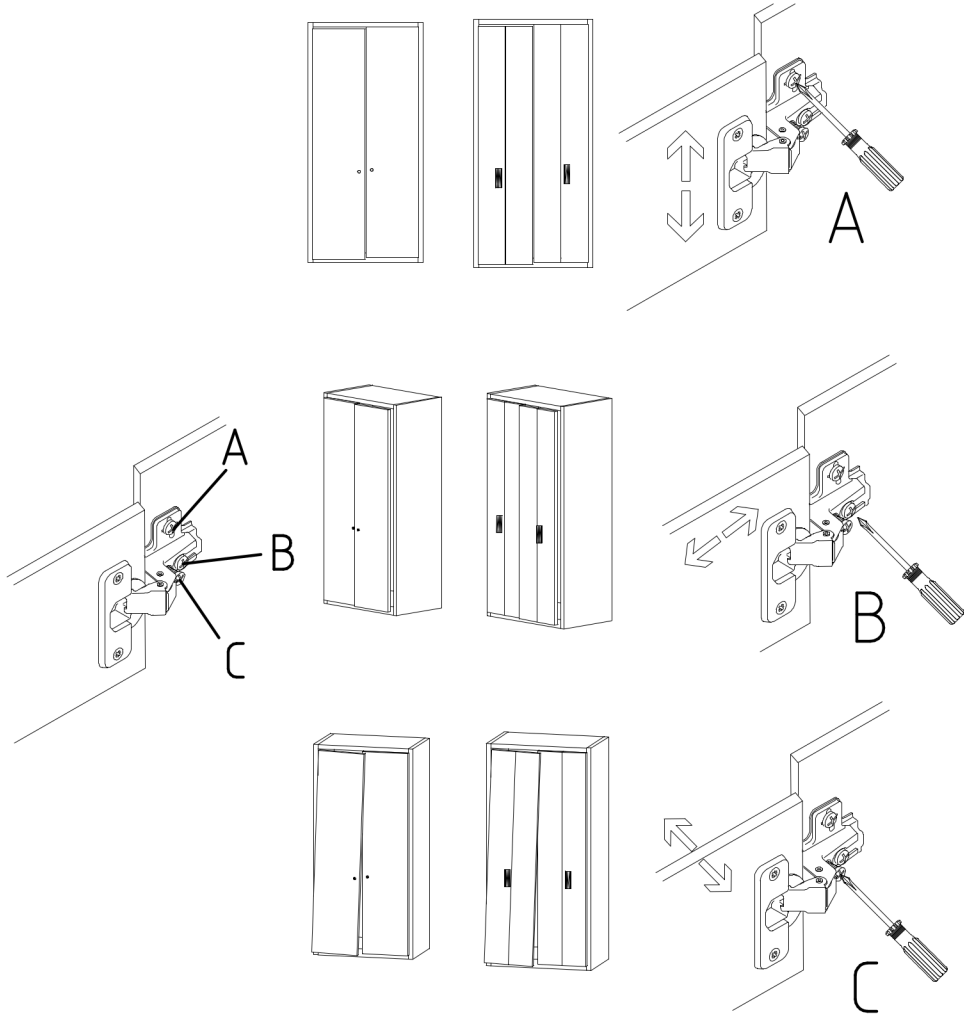

Modell/Model/Modèle

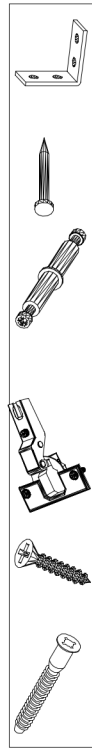
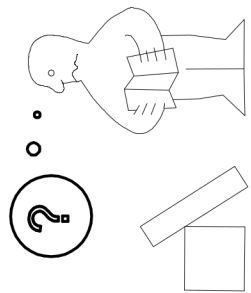
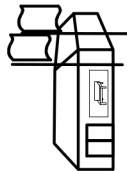
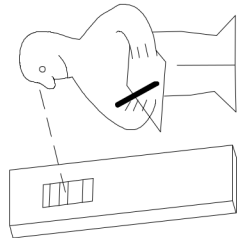
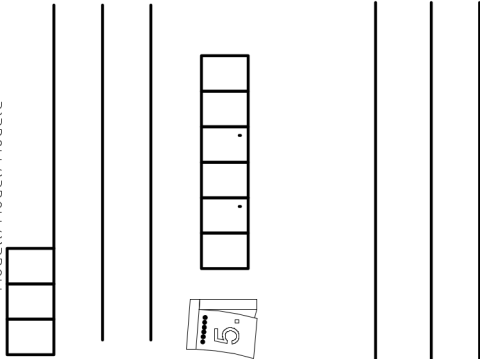

(121 370)	(G 1)	(4x)