

980336

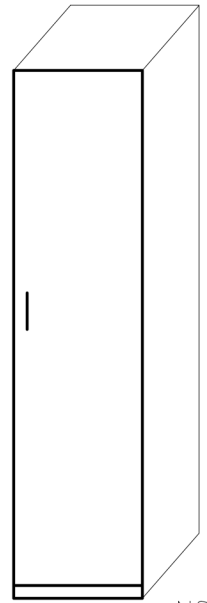

NSP 43 ZB

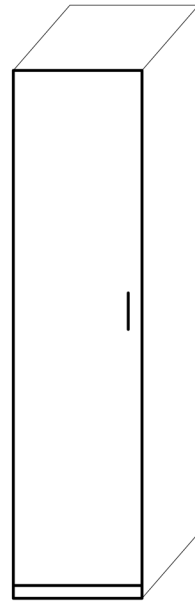

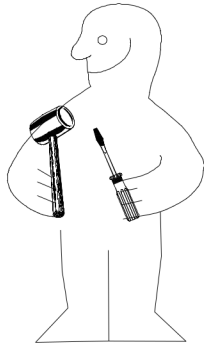
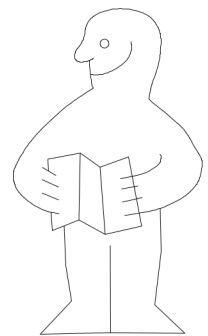
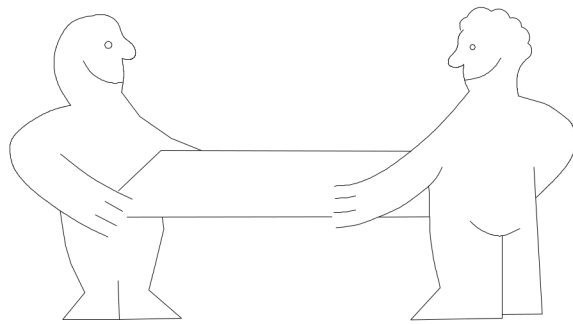
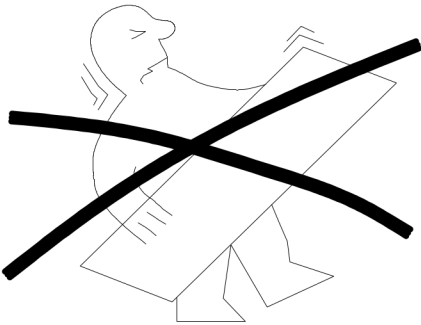

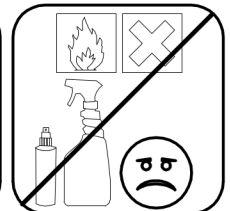
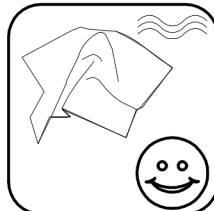
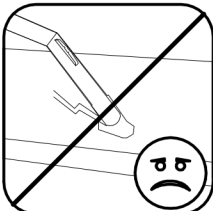
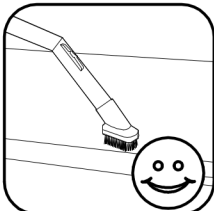
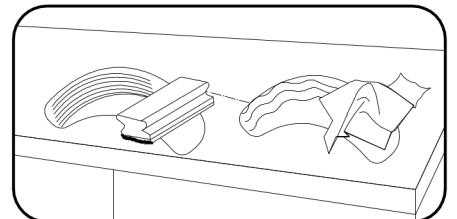
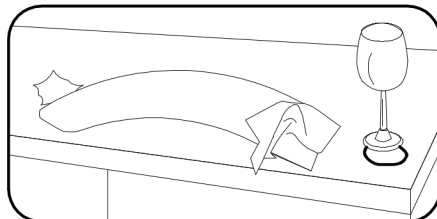
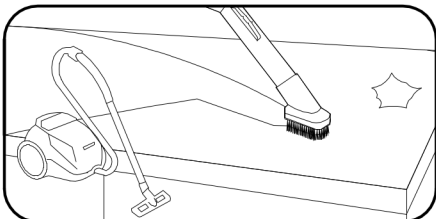
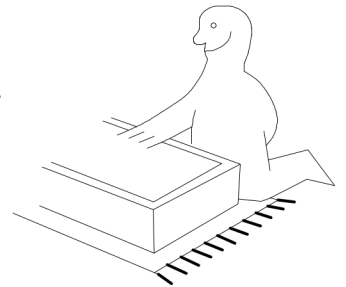
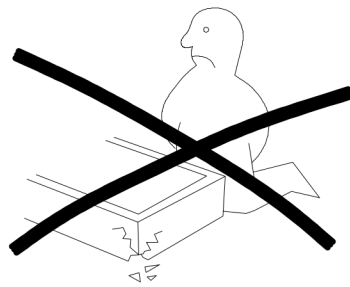
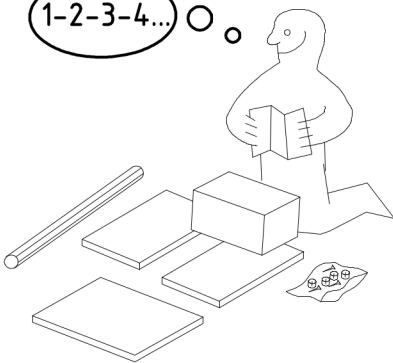
1-2-3-4... ○ ○







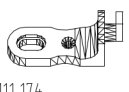
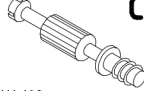

980336

06.04.16 / -

04 16 | 1/8

 111 102	<b>A</b> 8x
 111 610	<b>L7</b> 12x
 111 174	<b>J1</b> 2x
 111 103	<b>C</b> 8x

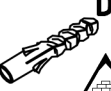
 112 268	<b>M</b> 3x
 112 267	<b>N</b> 3x
 M6 x 11 mm	<b>T6</b> 2x
 3,5 x 15 mm	<b>G1</b> 2x

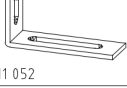
 111 618	<b>D20</b> 1x
 6 X 60 mm	<b>G16</b> 1x
 4 X 15mm	<b>SP15</b> 1x
 111 052	<b>o10</b> 1x

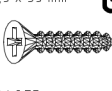
 3,5 x 35 mm	<b>G14</b> 4x
---	------------------

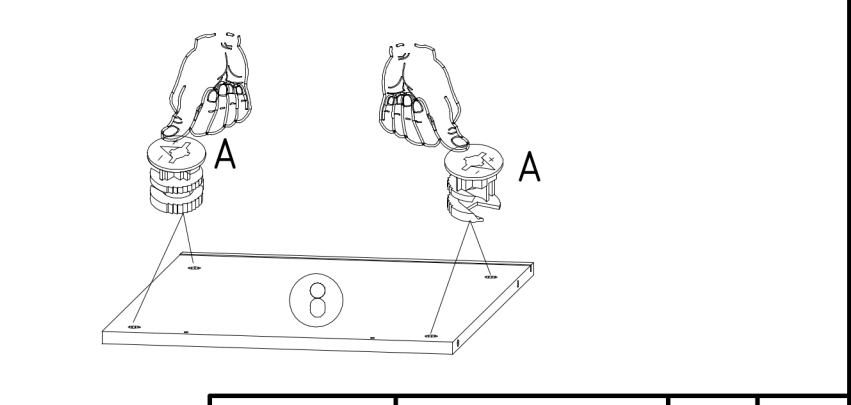
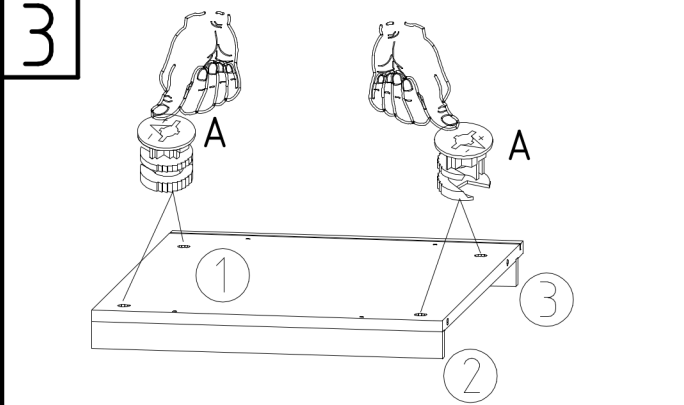
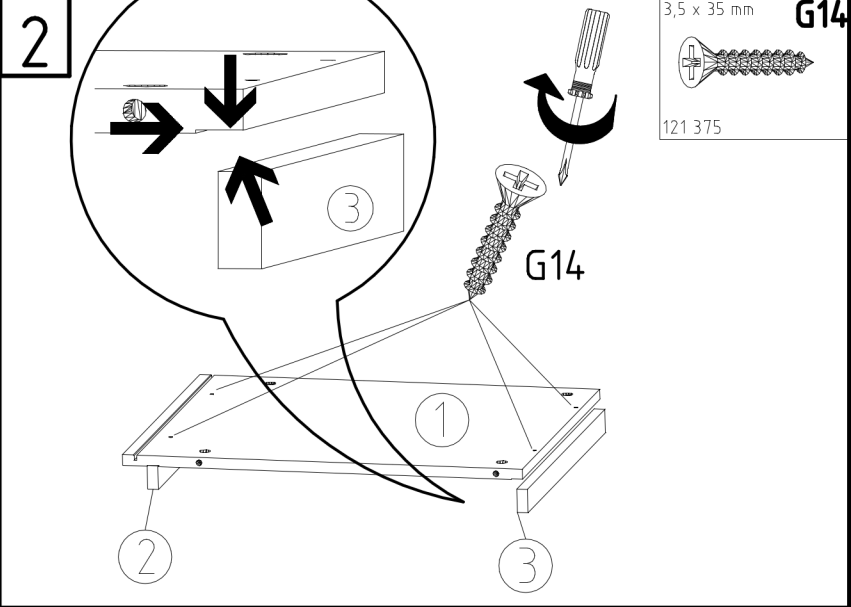
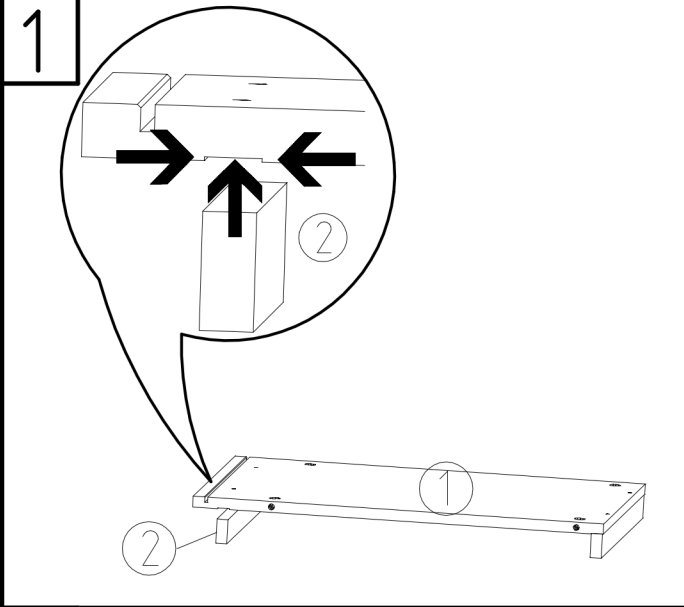
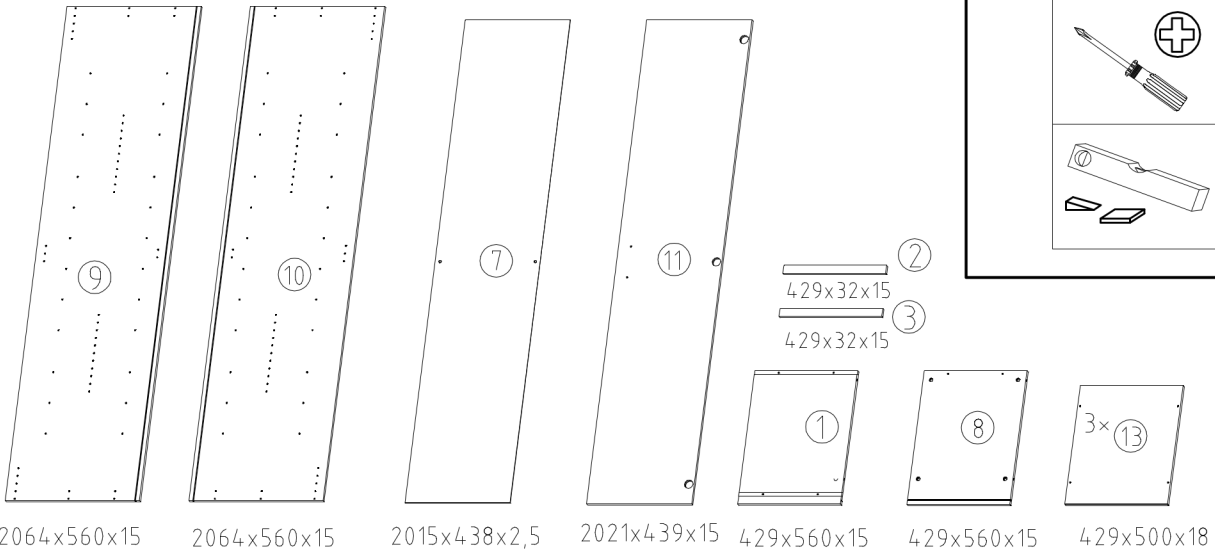
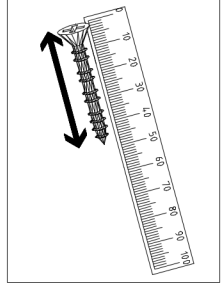
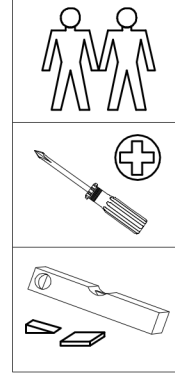
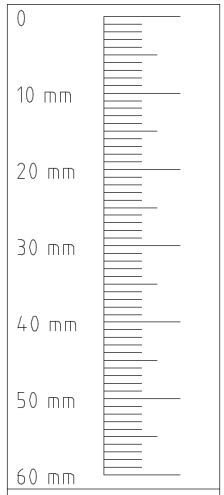

4

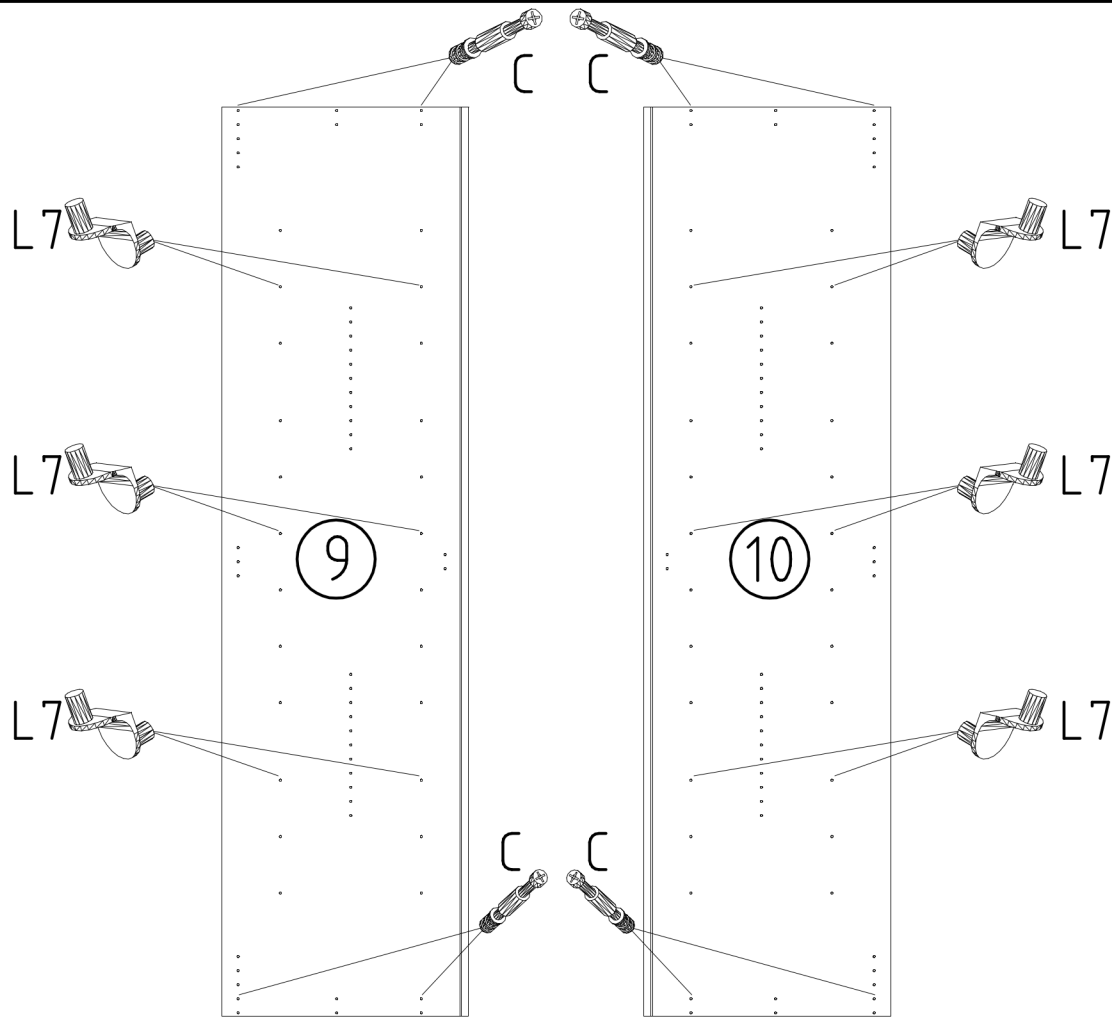

5

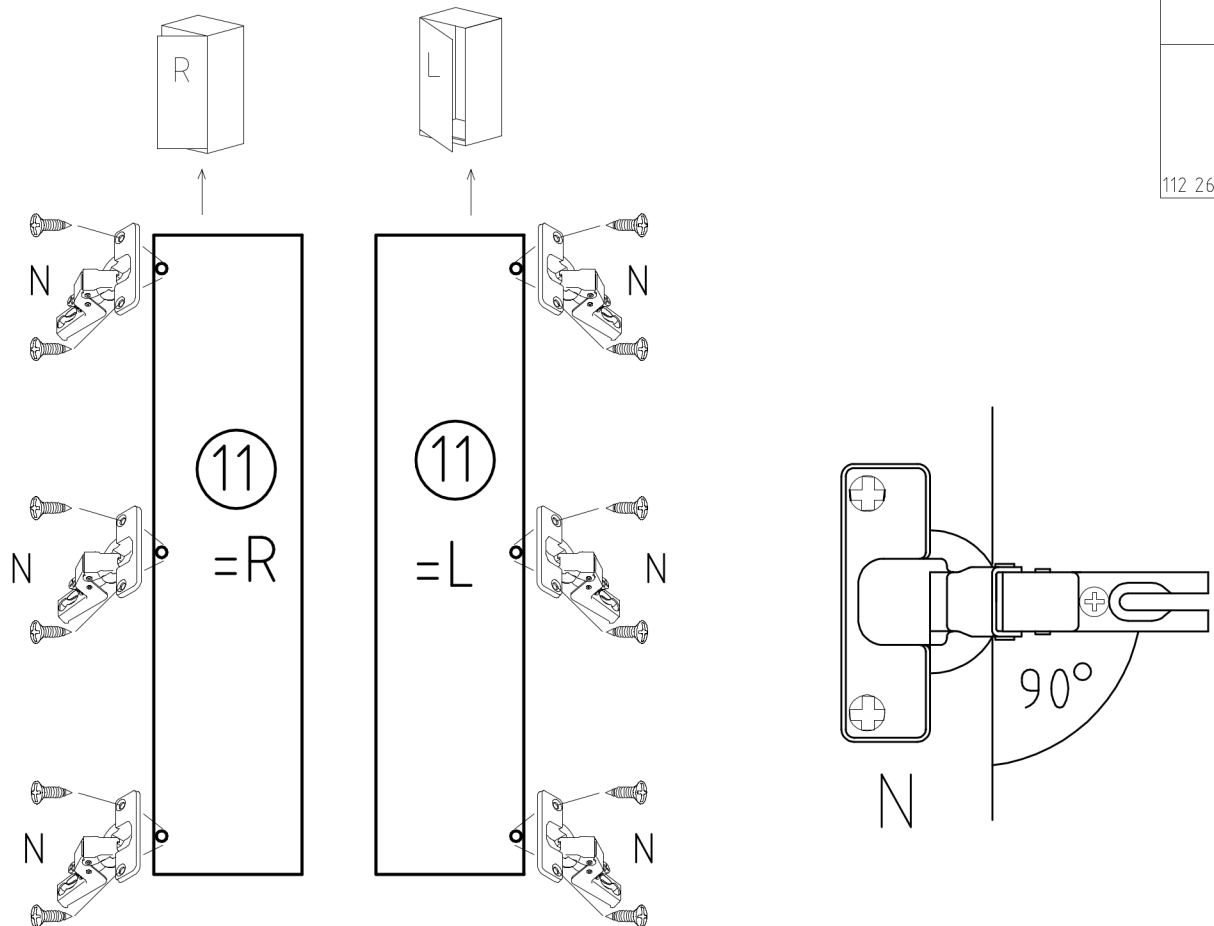

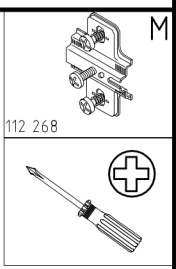
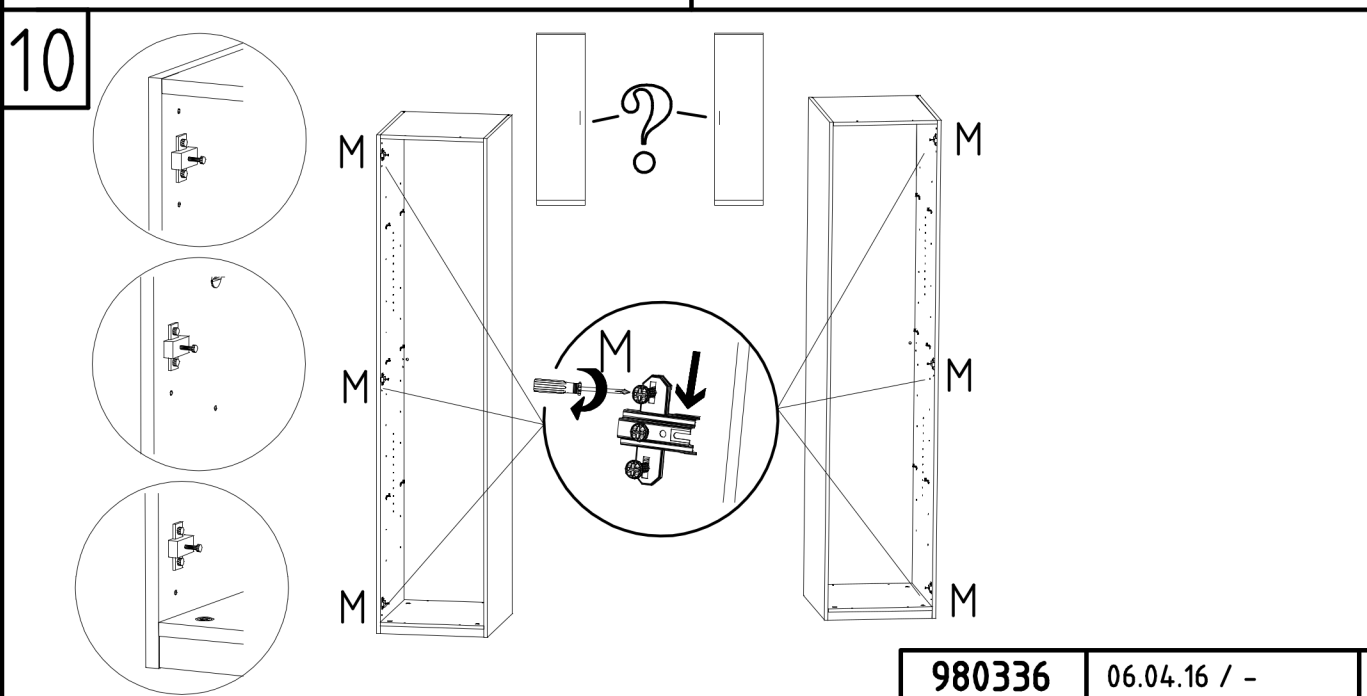
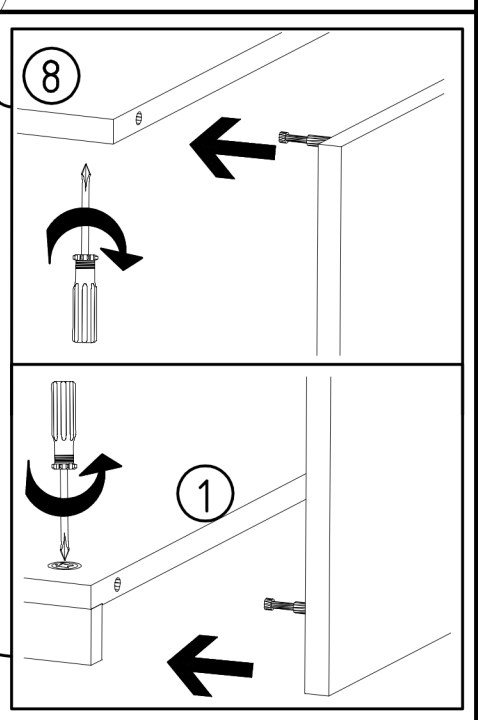
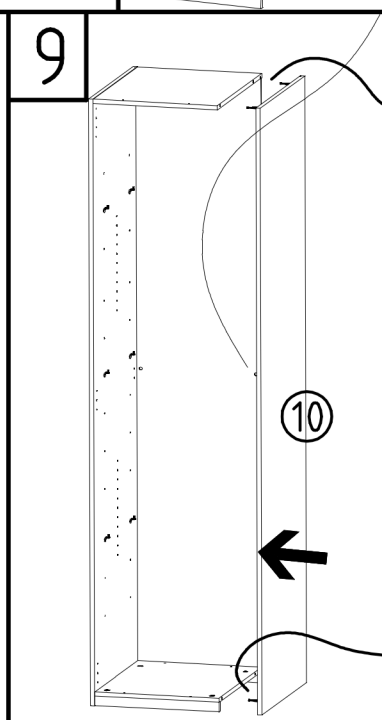
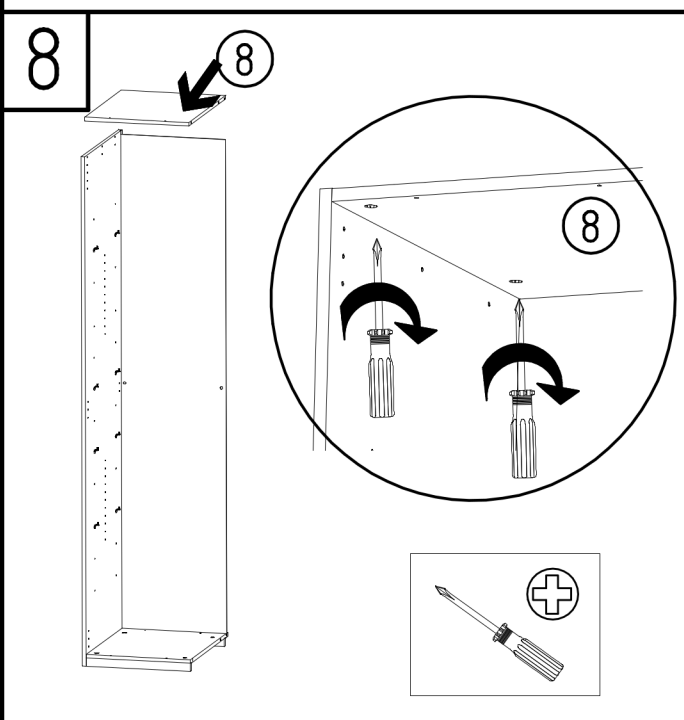
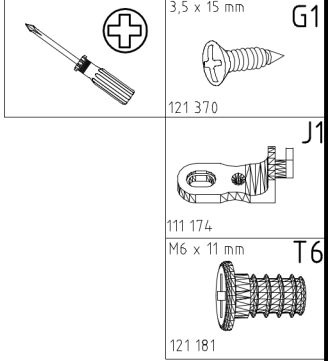
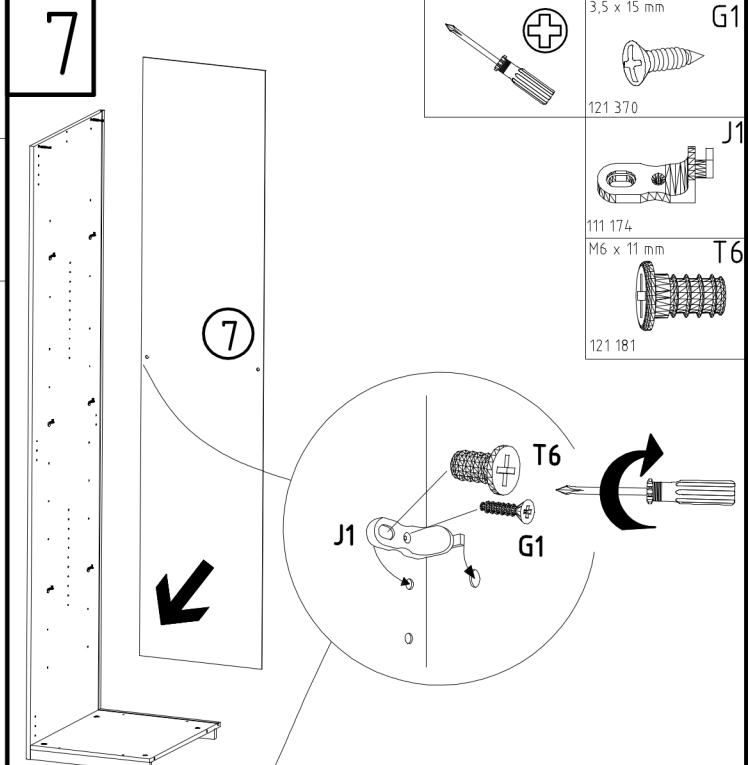
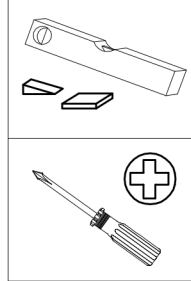
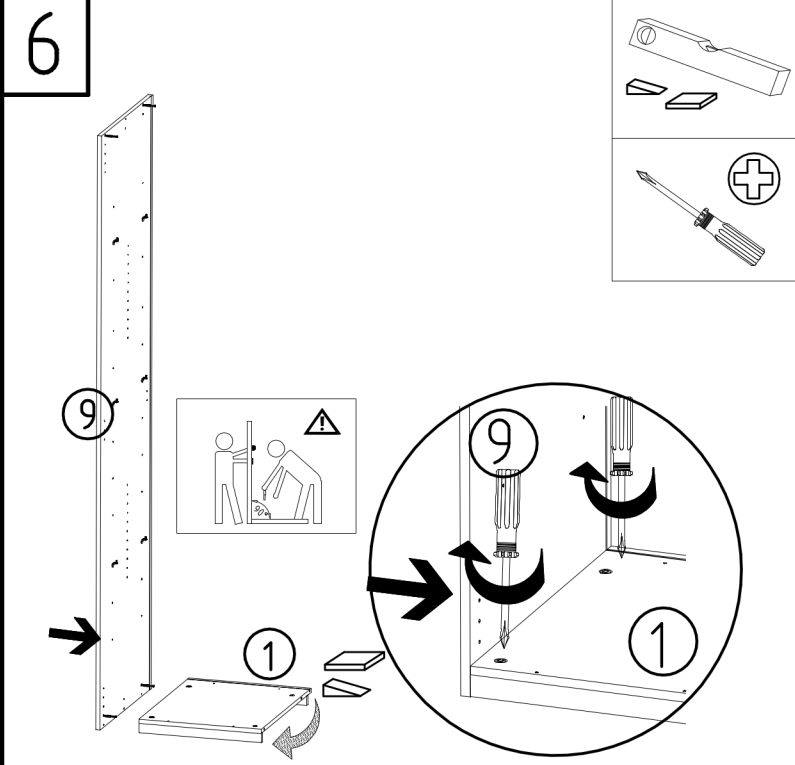

11

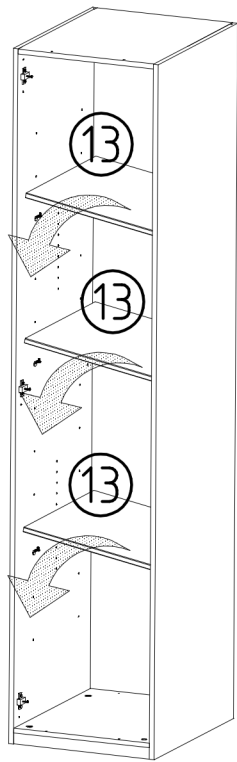

12

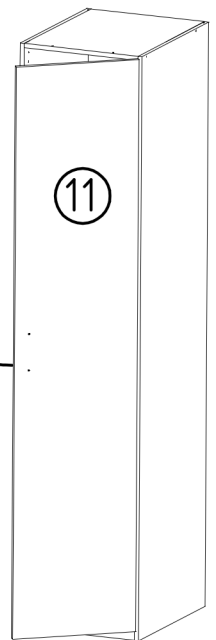
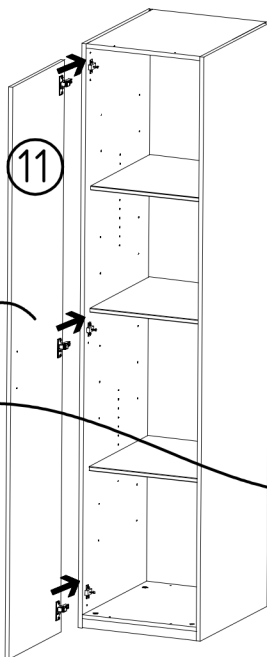
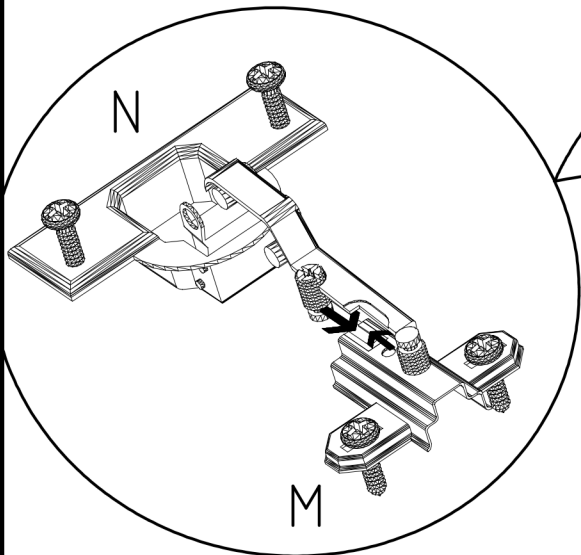
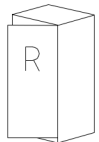
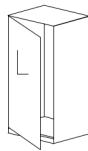
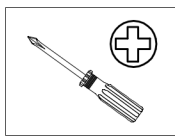

13

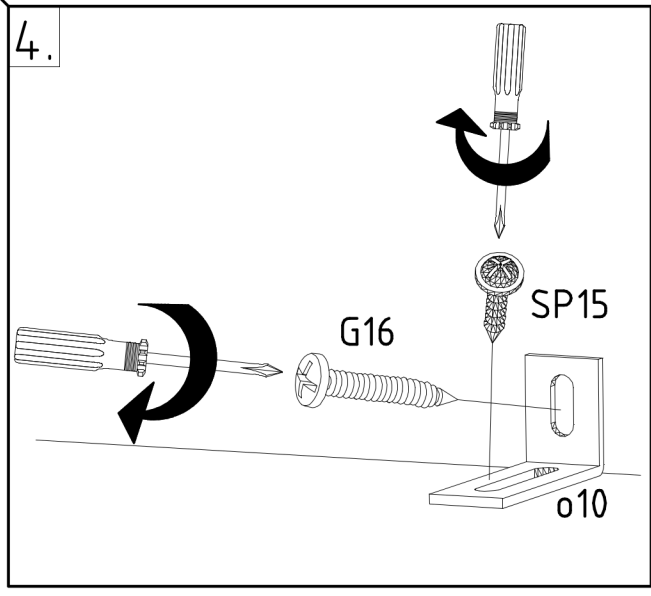
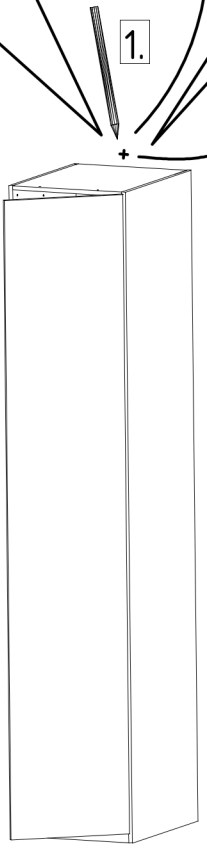
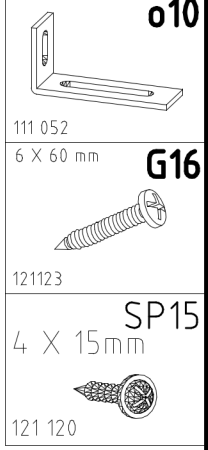
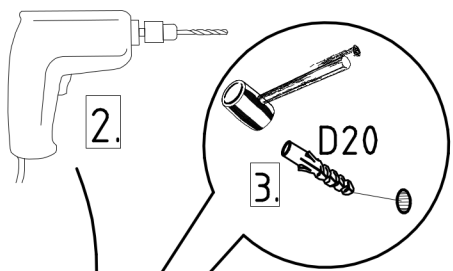
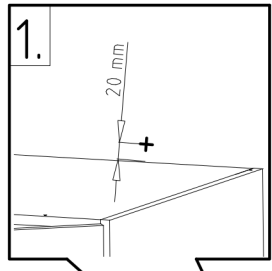
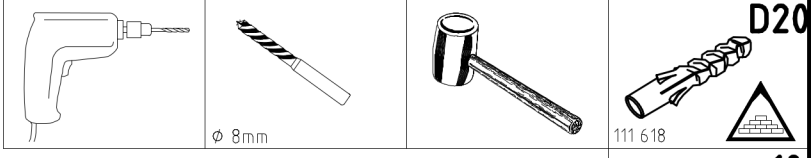
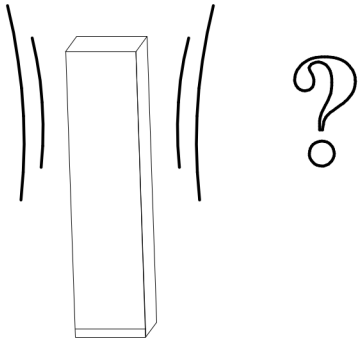

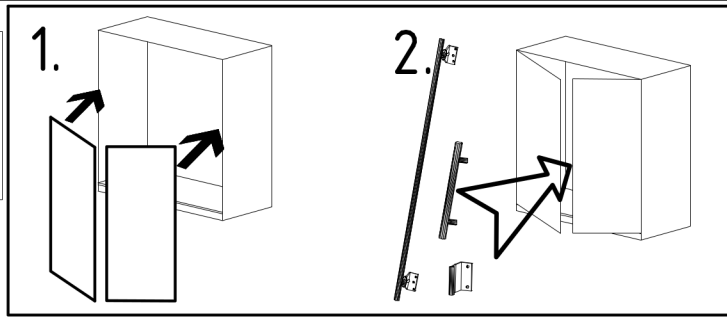

3,5 x 15 mm 121 370	G1	4,0 x 12 mm 122 625	G56
------------------------	----	------------------------	-----

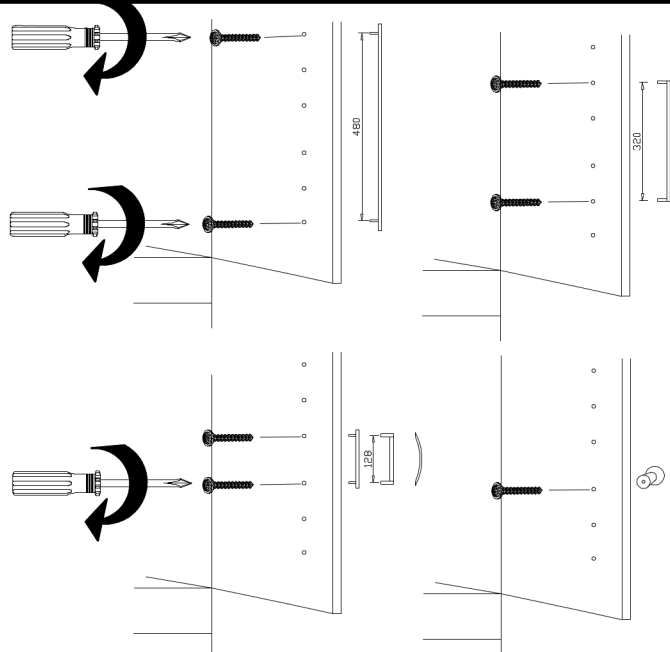
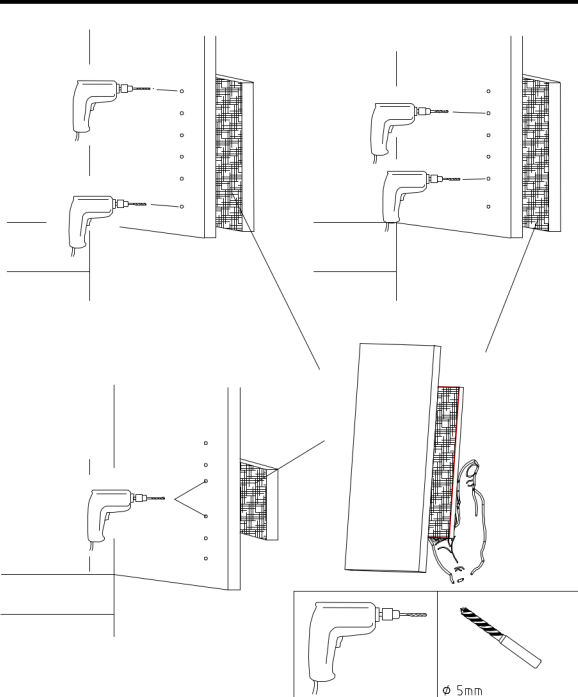
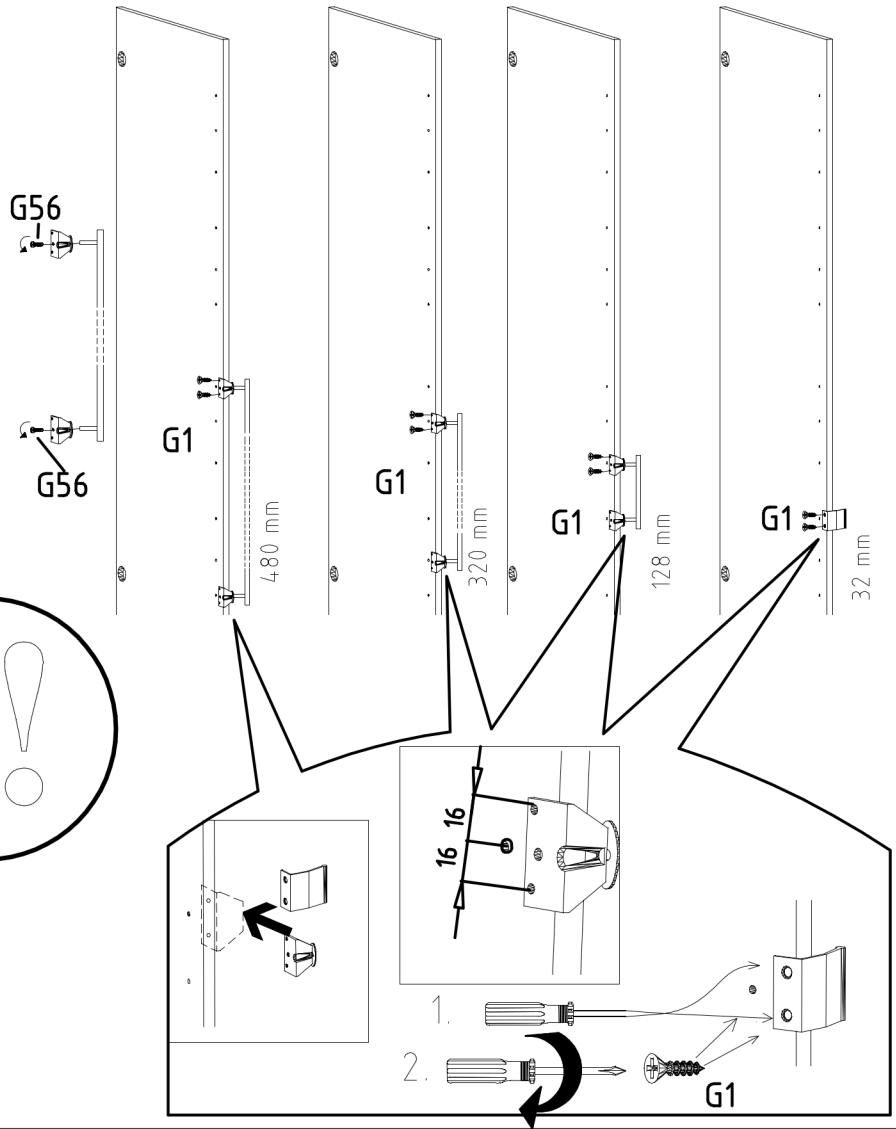
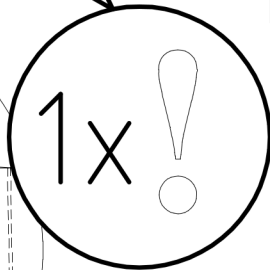
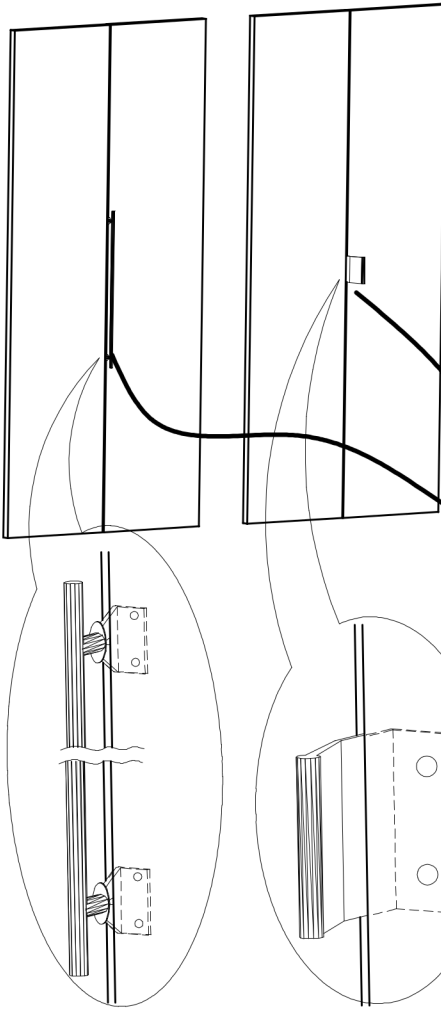

	SP27
4 X 27mm	
122620	
4,0x22	G49
122 609	

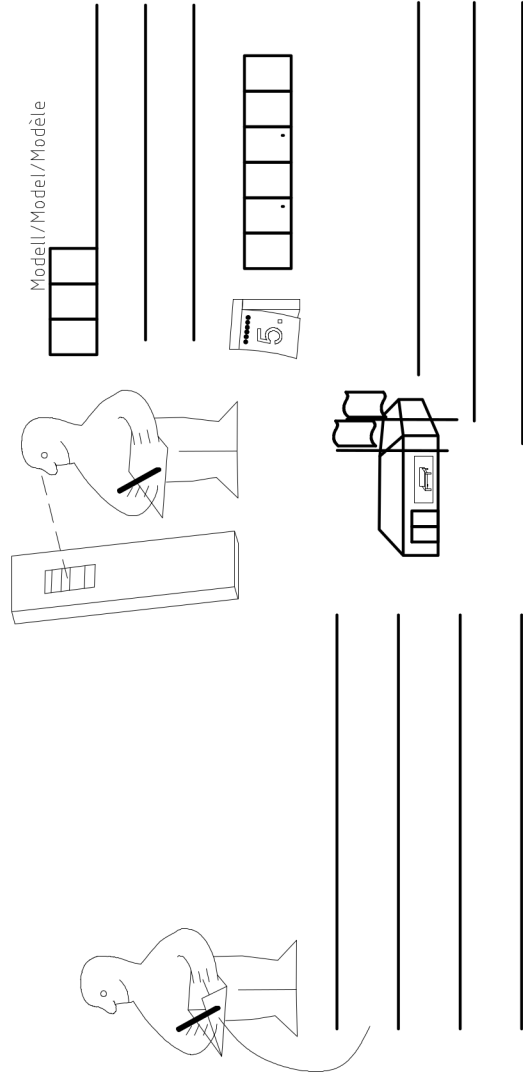
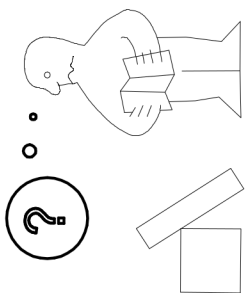
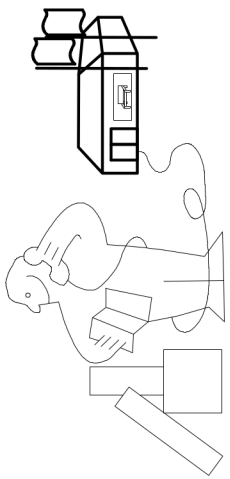
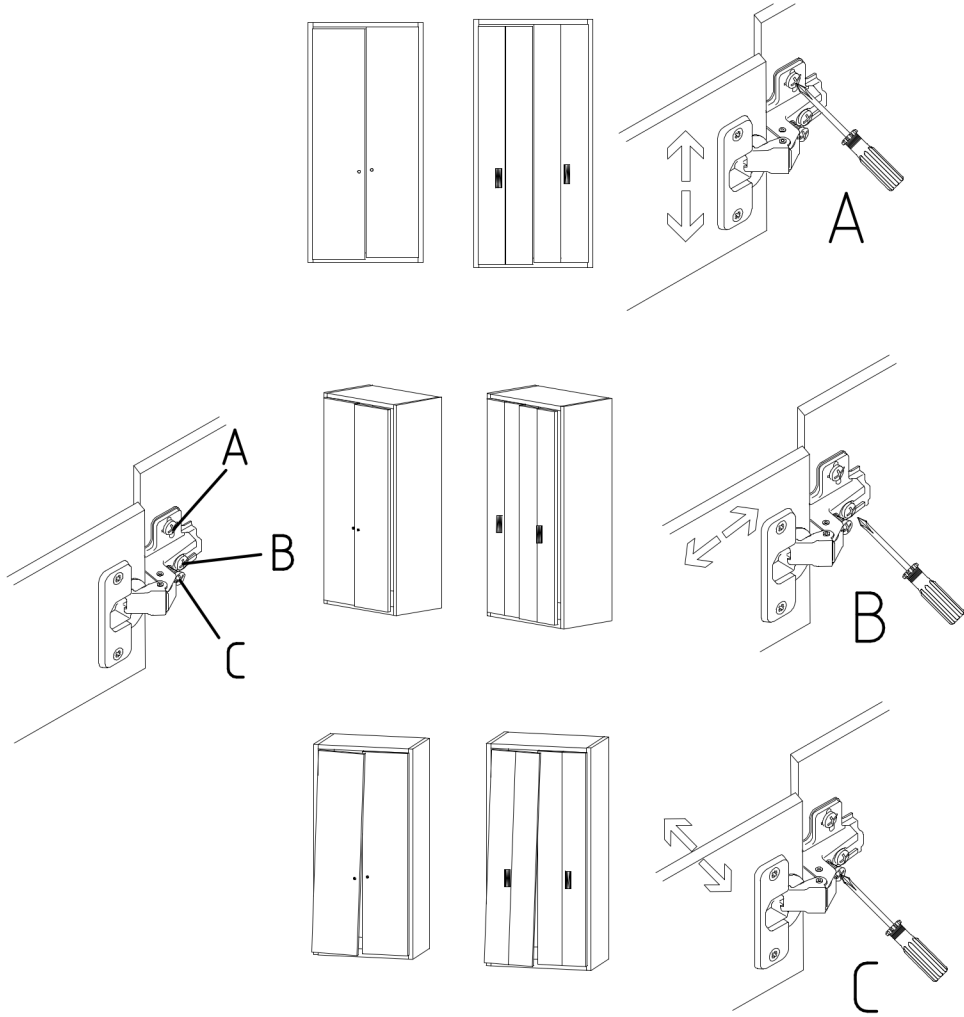

Modell/Model/Modèle

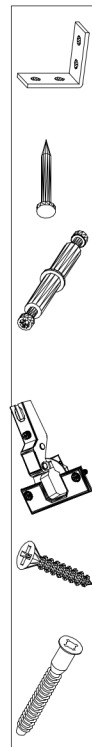

(121 370)	( G 1 )	(4x)