

29.03.2017

- | | |
|----------------------------------|------------------------------|
| (D) Montageanleitung | (GB) Assembly Instructions |
| (FR) Notice de montage | (IT) Istruzioni di montaggio |
| (NL) Handleiding voor de montage | (PL) Instrukcja montażu |
| (CZ) Montážní návod | (SK) Návod na montáž |
| (HU) Szerelési útmutató | (RO) Instrucțiuni de montaj |
| (TR) Montaj talimatı | (RU) Инструкции по монтажу |

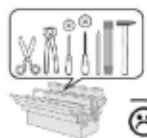





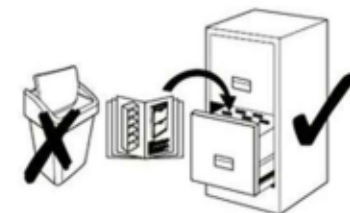
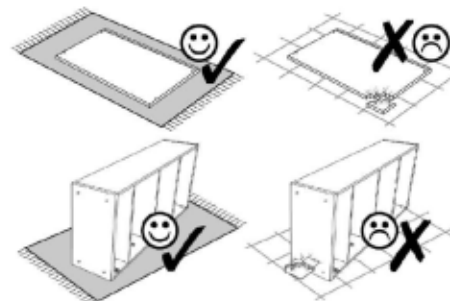
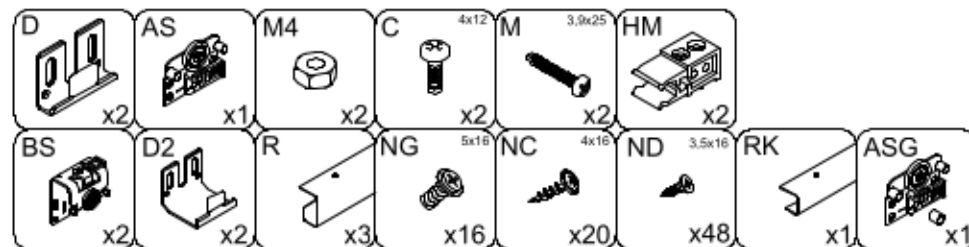
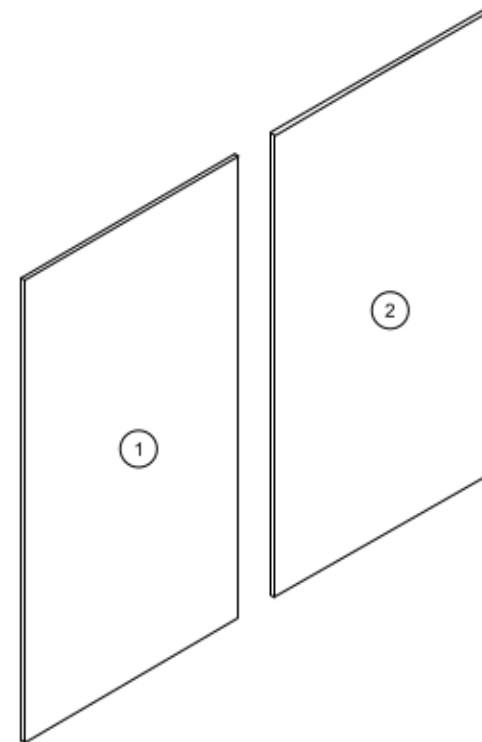

2-2,5

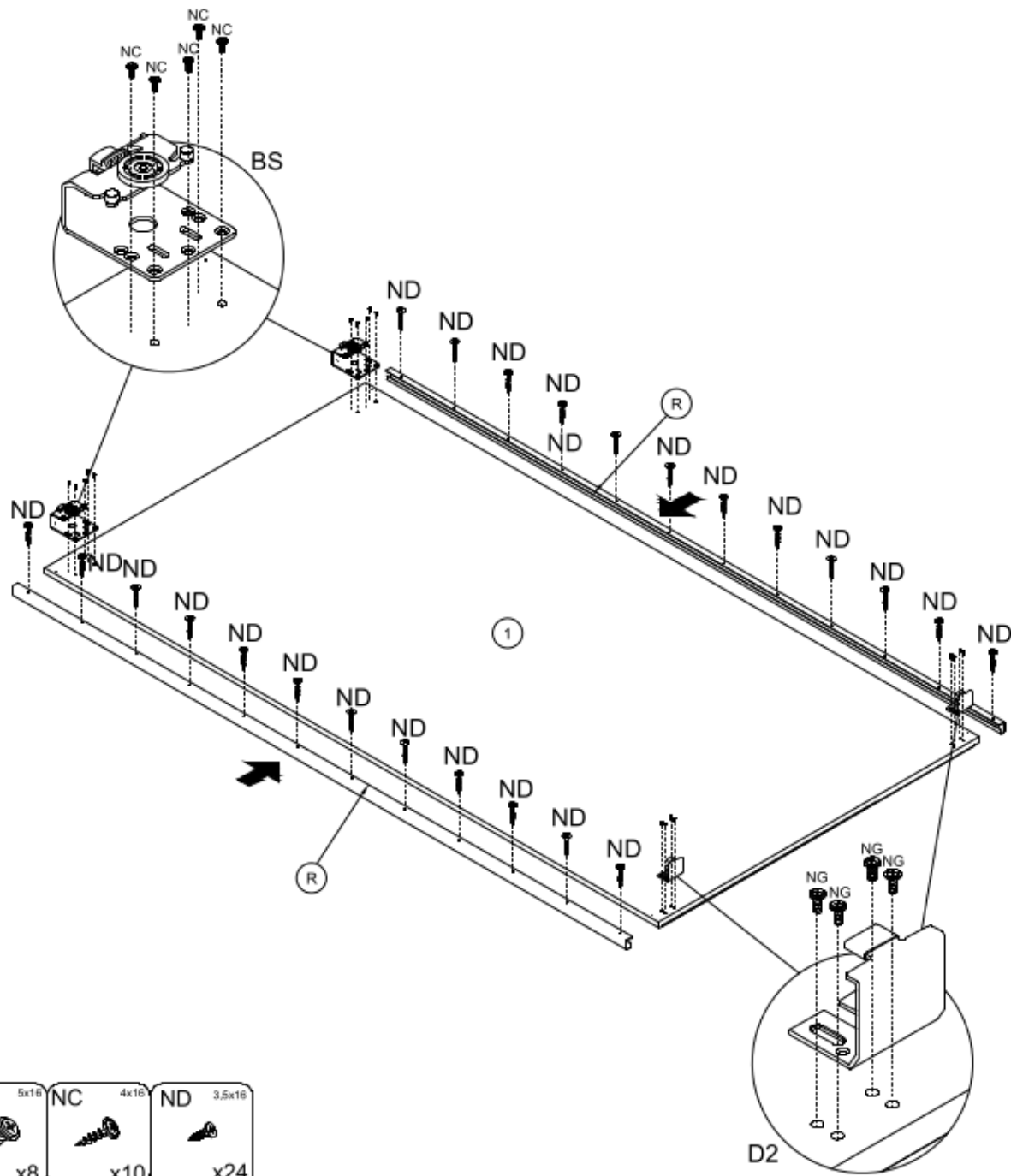
1









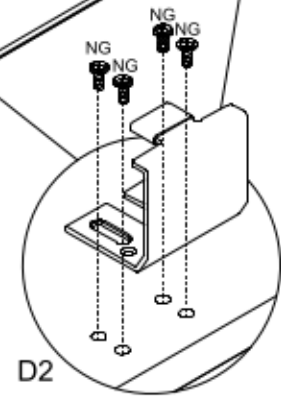

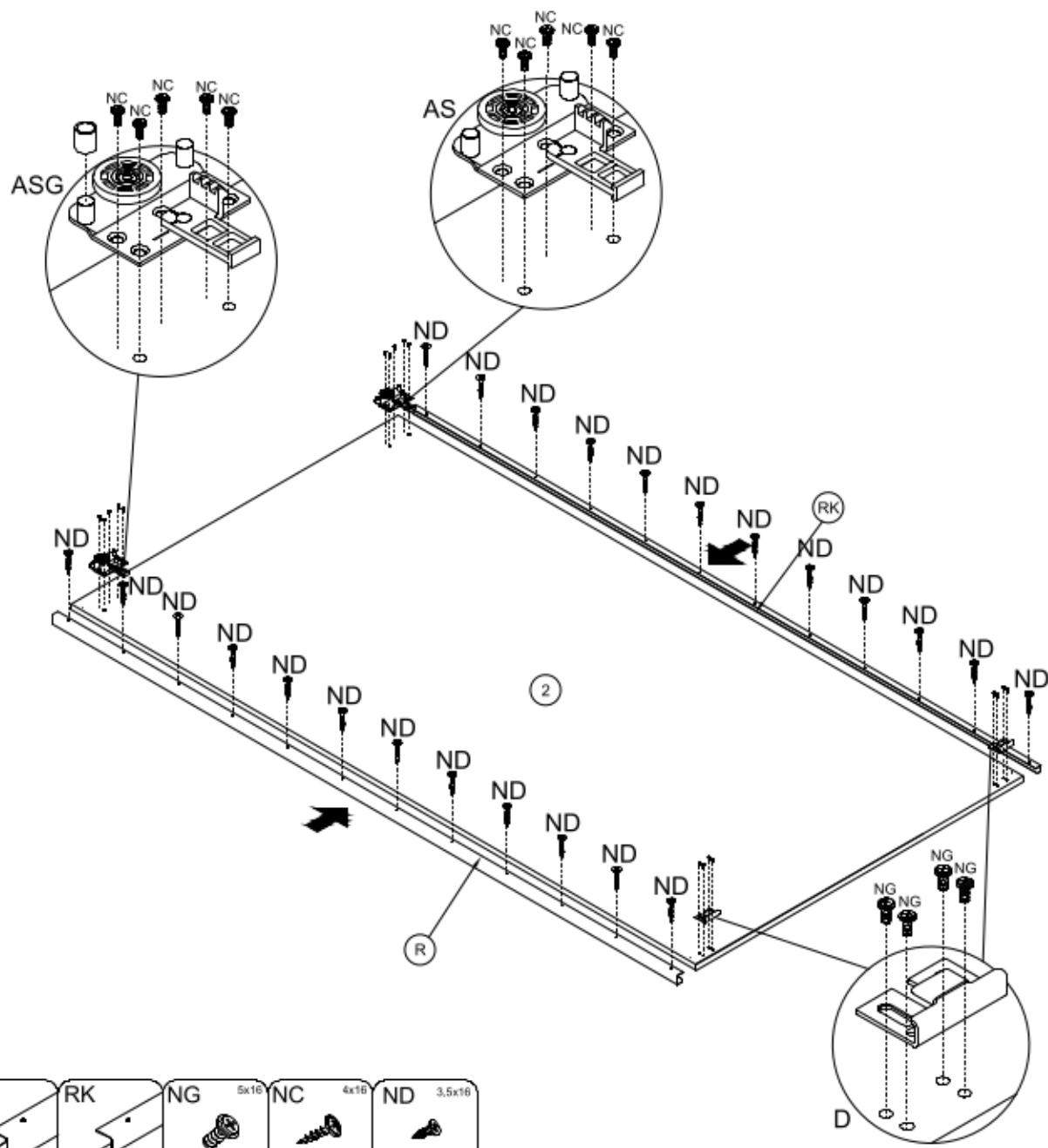
2





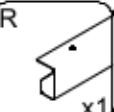
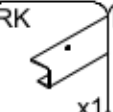

BS 	D2 	R 	NG 5x16 	NC 4x16 	ND 3,5x16 
x2	x2	x2	x8	x10	x24



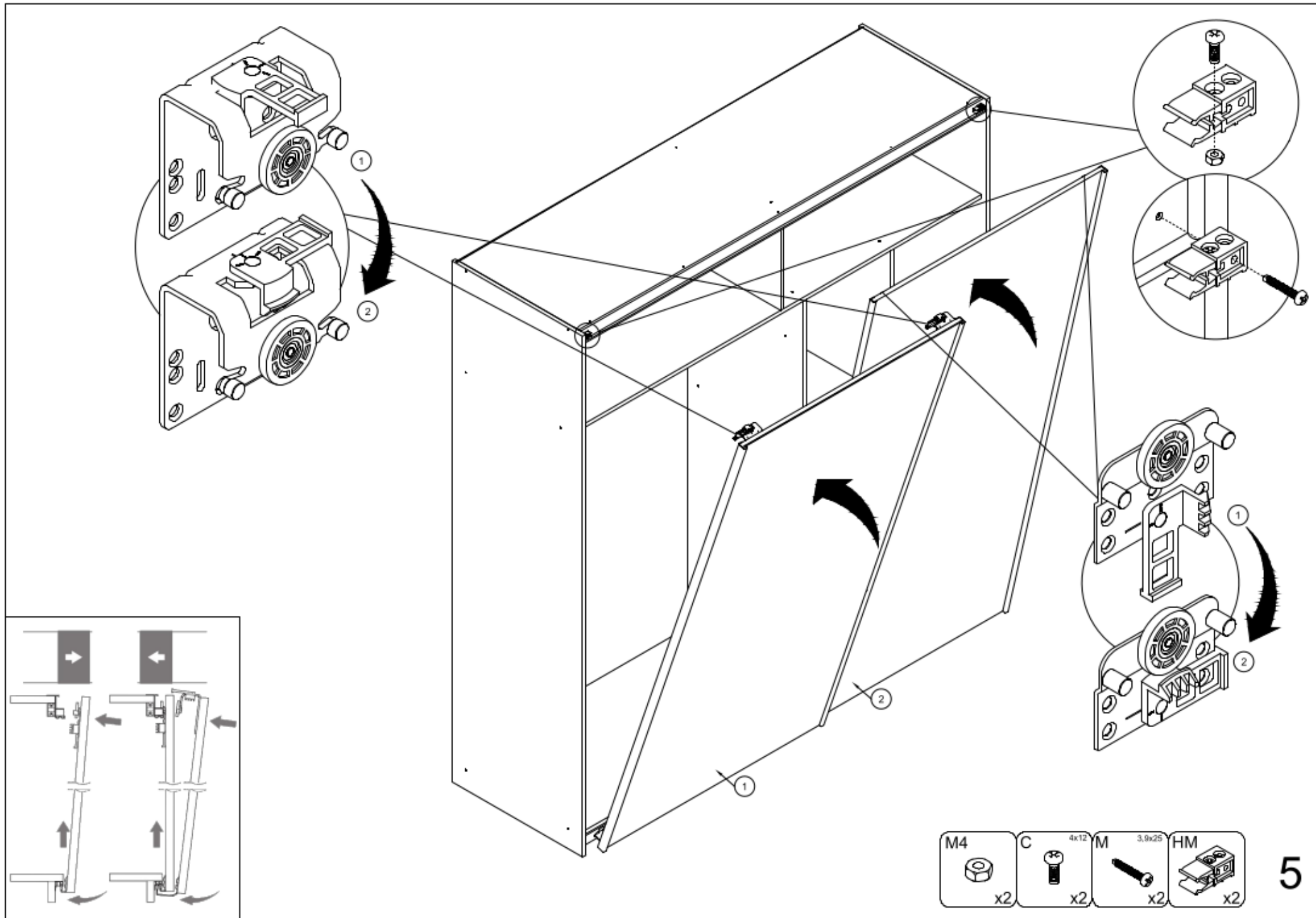

- | | | | | | | | |
|---|---|---|---|---|---|---|--|
|  |  |  |  |  |  |  |  |
| x2 | x1 | x1 | x1 | x1 | x8 | x10 | x24 |



- | | | | |
|---|---|---|---|
| M4 | C 4x12 | M 3,9x25 | HM |
|  |  |  |  |
| x2 | x2 | x2 | x2 |