













Cura

A	1900x520	1/5
B	1900x520	1/5
C	1788x500	2/5
D	1468x500	3/5
E	1468x500	3/5
F	978x500	3/5
G	474x500	3/5

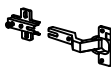
H	2x 474x420	3/5
I	1468x 80	3/5
J	420x 80	2/5
K	3x 485x1294	4/5
L	3x 485x 520	5/5
M	3x 1815x497	2/5

18x  10174	2x  10072	28x  10013	22x  50317	2x  50011	6x  50738	8x  50332
12x  40160	3x  40163	6x  20278	12x  M 4x18 10186	67x  Φ 3,5/16 10001	 10033	

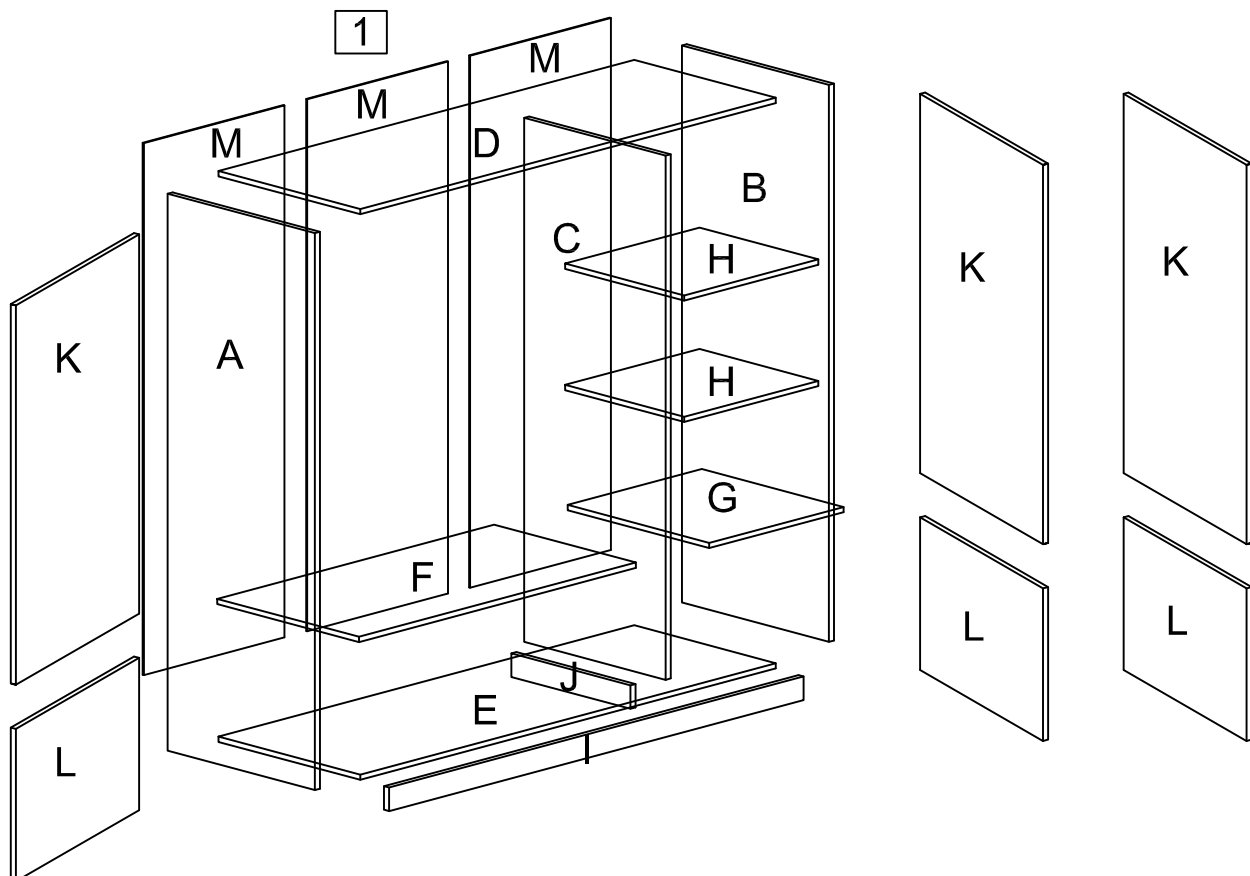

1.1

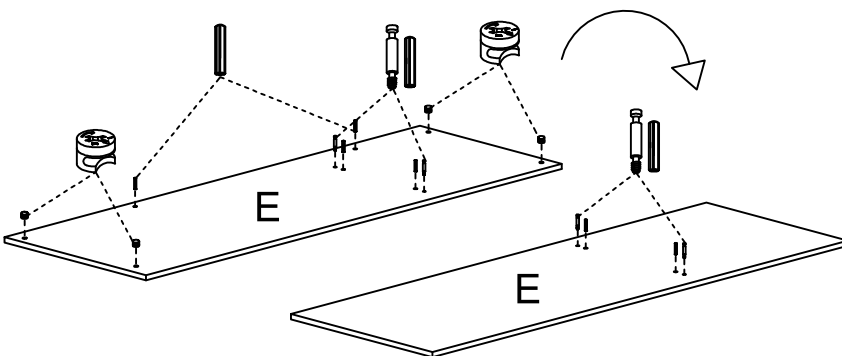
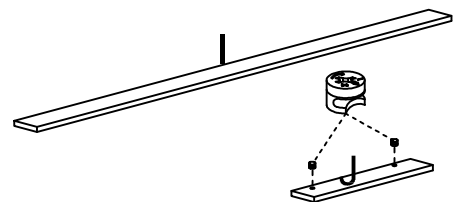
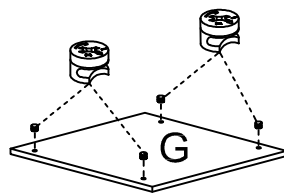
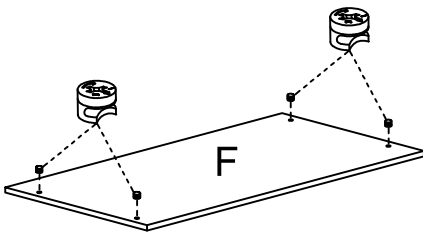
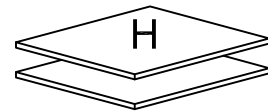
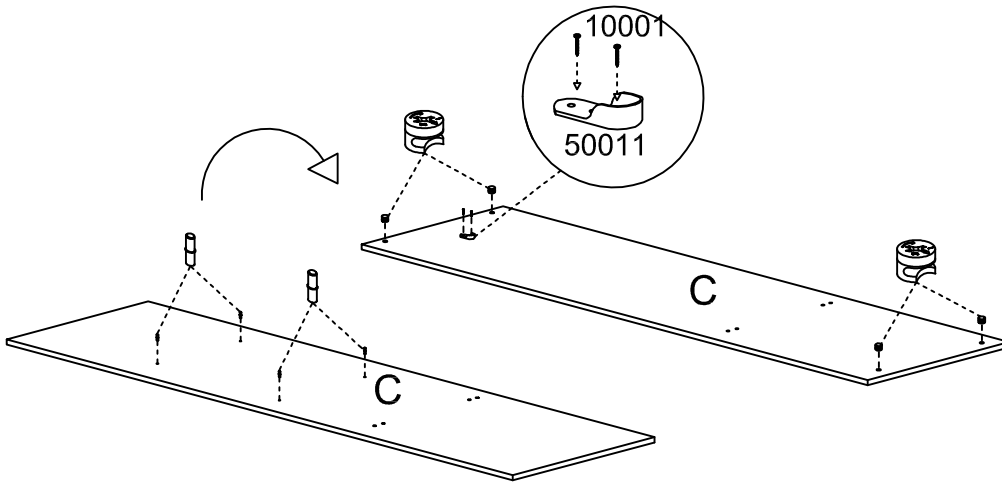
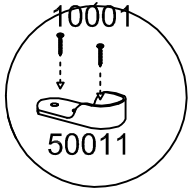
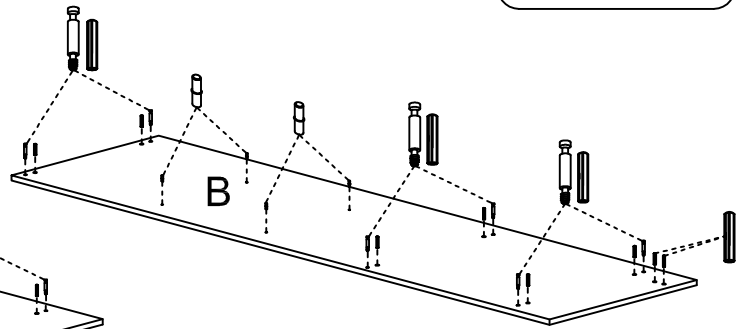
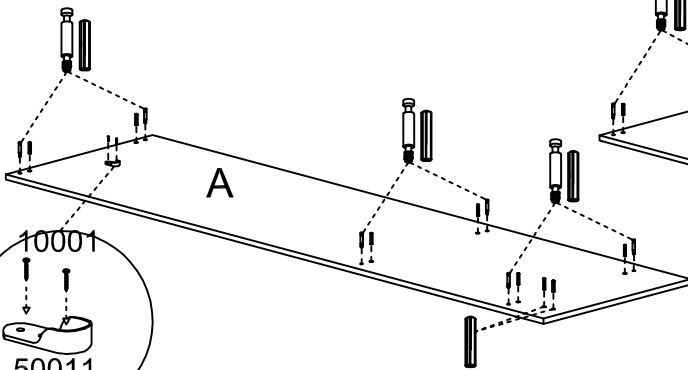
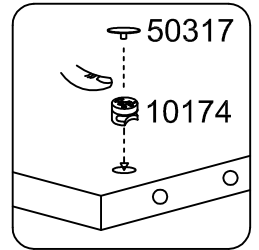
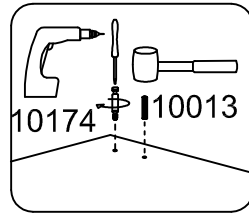
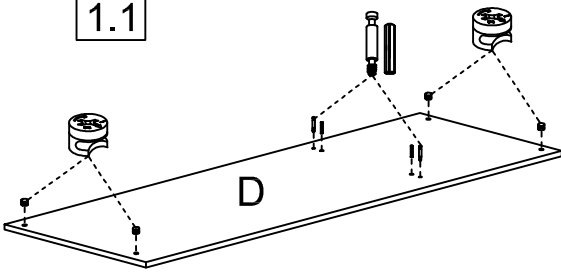

1.2

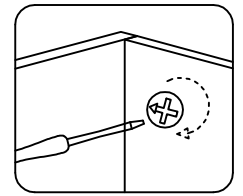
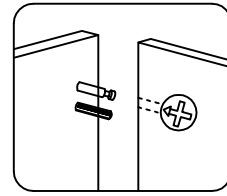
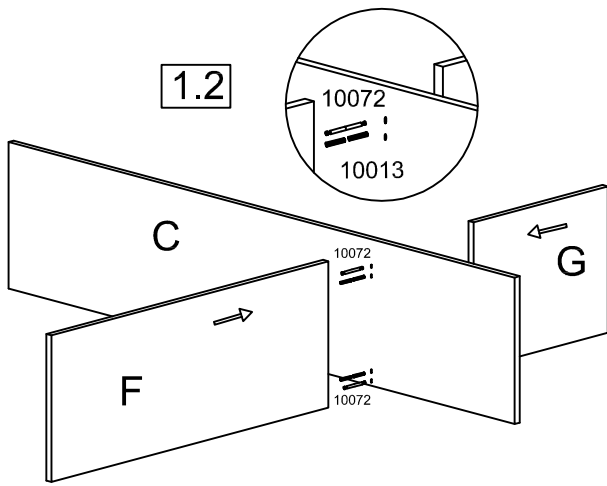

1.3

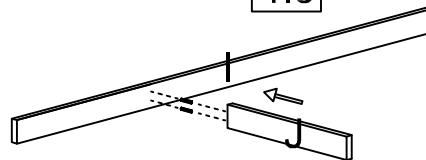

1.4

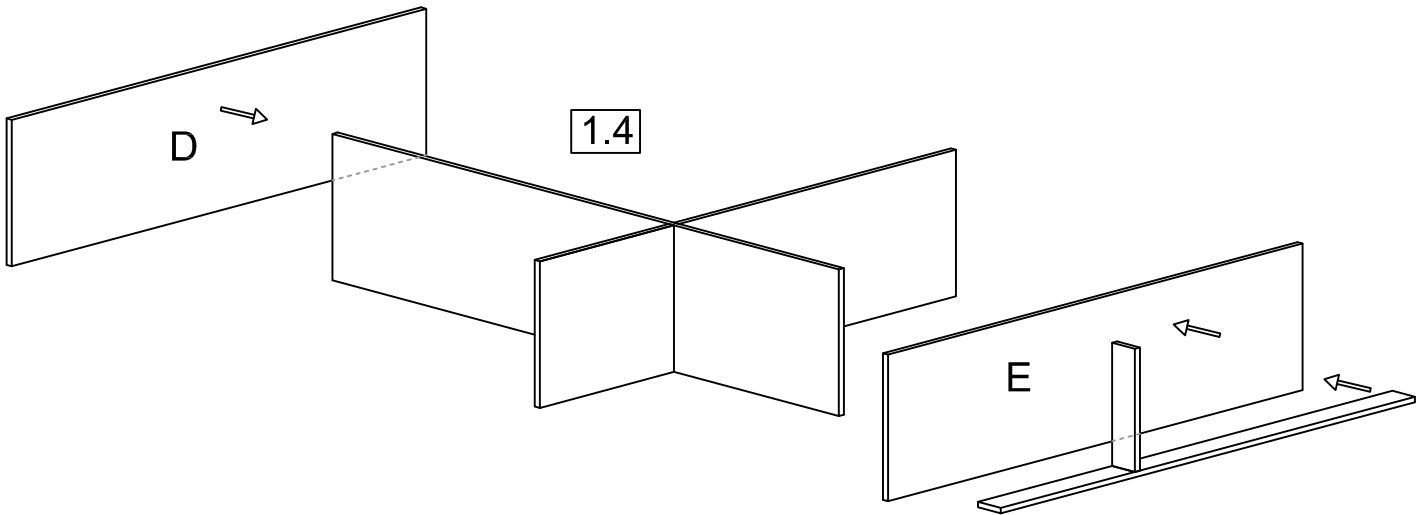

1.5

