

MONTAGEANLEITUNG  
INSTRUKCJA MONTAŻU  
FITTING-UP INSTRUCTION  
ІНСТРУКЦІЯ МОНТАЖУ  
ИНСТРУКЦИЯ СБОРКИ

MONTÁŽNY NÁVOD  
INSTRUCTIONS POUR LE MONTAGE  
INSTRUCCIONES DE MONTAJE  
SZERELÉSI ÚTMUTATÓ  
UPUTE ZA SASTAVLJANJE

Notwendiges Montagewerkzeug:  
Do montażu potrzebne są:  
You need for fitting-up:  
Для монтажу потрібно:  
Для сборки нужны:

Pour le montage il faut:  
Para realizar el montaje es necesario:  
K montá i potrebuje:  
A szereléshez szükséges:  
Za sastavljanje su potrebne:

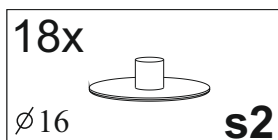
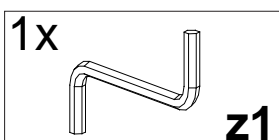
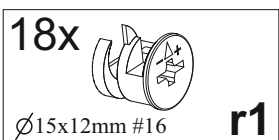
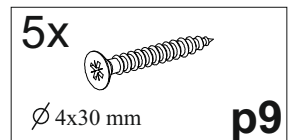
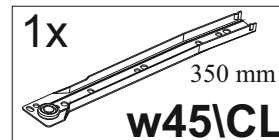
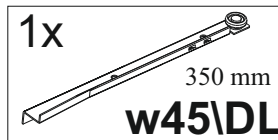
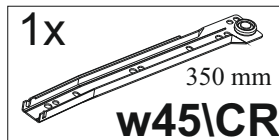
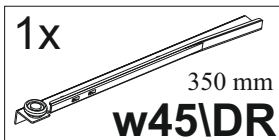
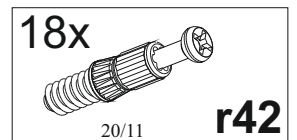
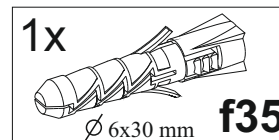
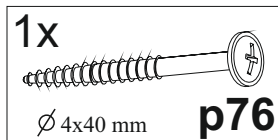
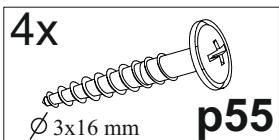
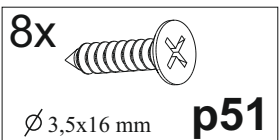
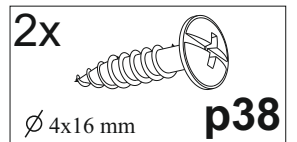
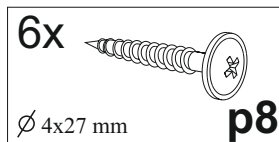
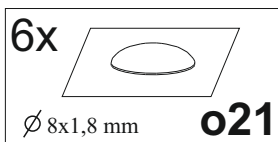
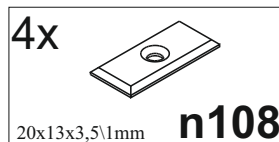
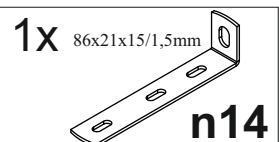
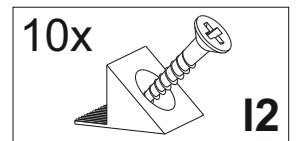
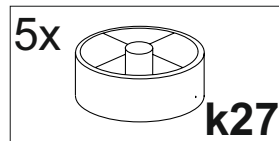
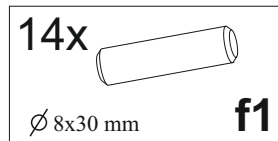
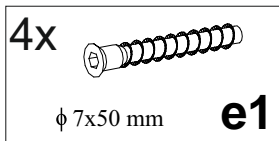
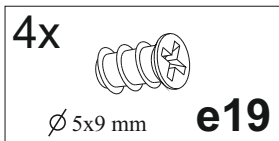
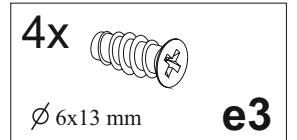
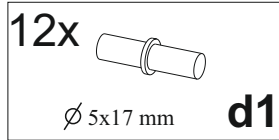
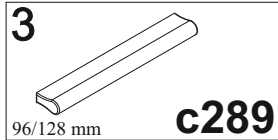
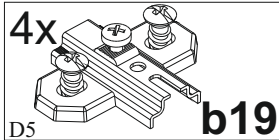
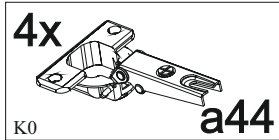
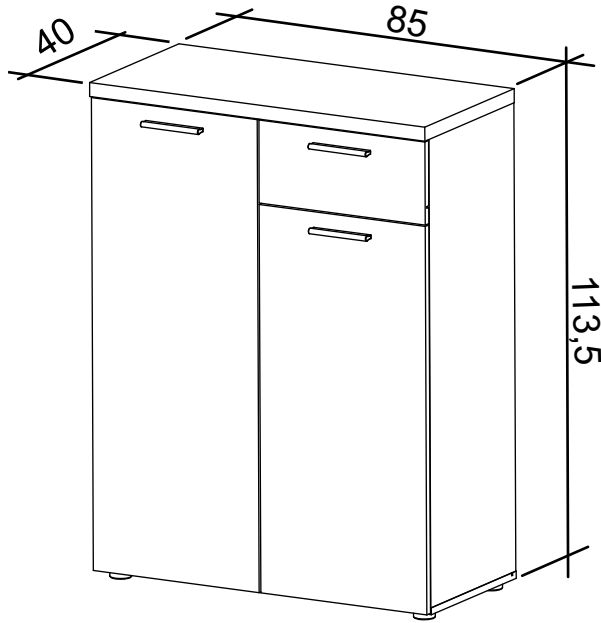
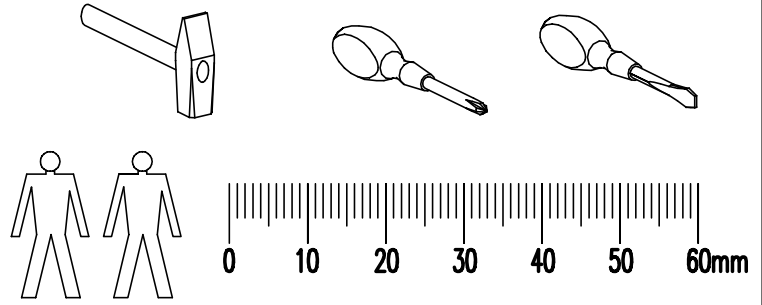
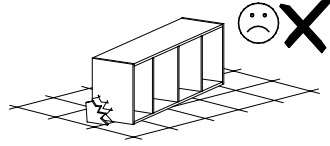
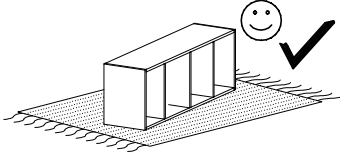

max.



5KG 109

max.



10KG 107

max.



3KG 114

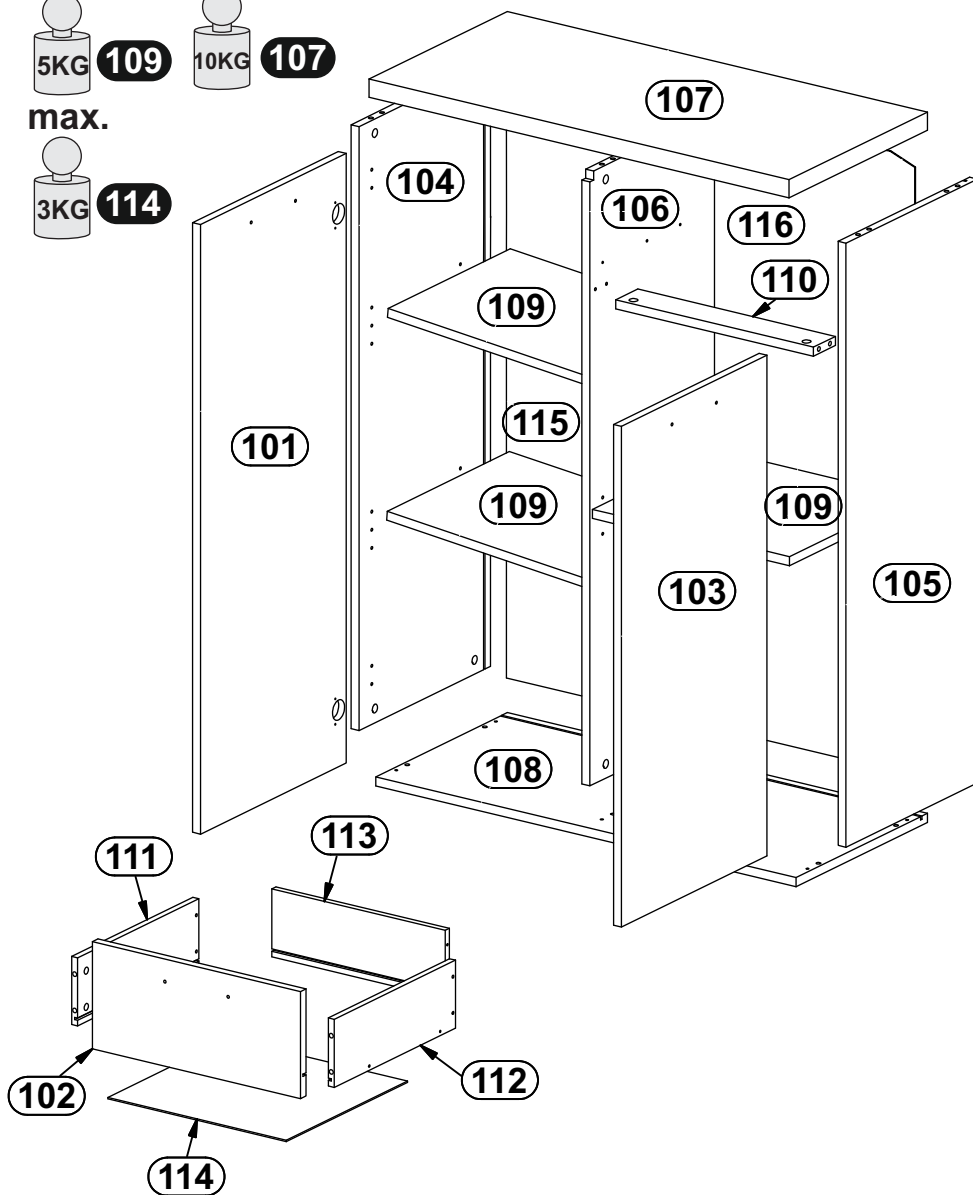

# 1

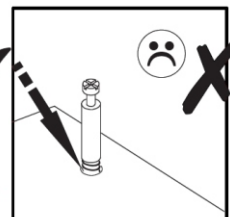
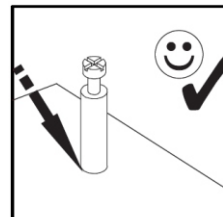
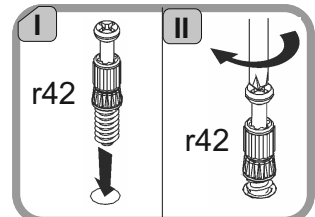
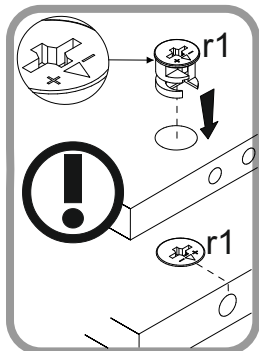
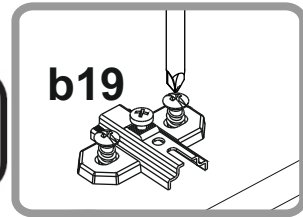
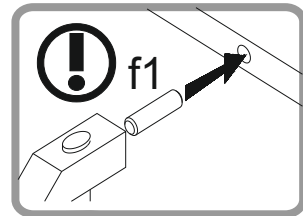
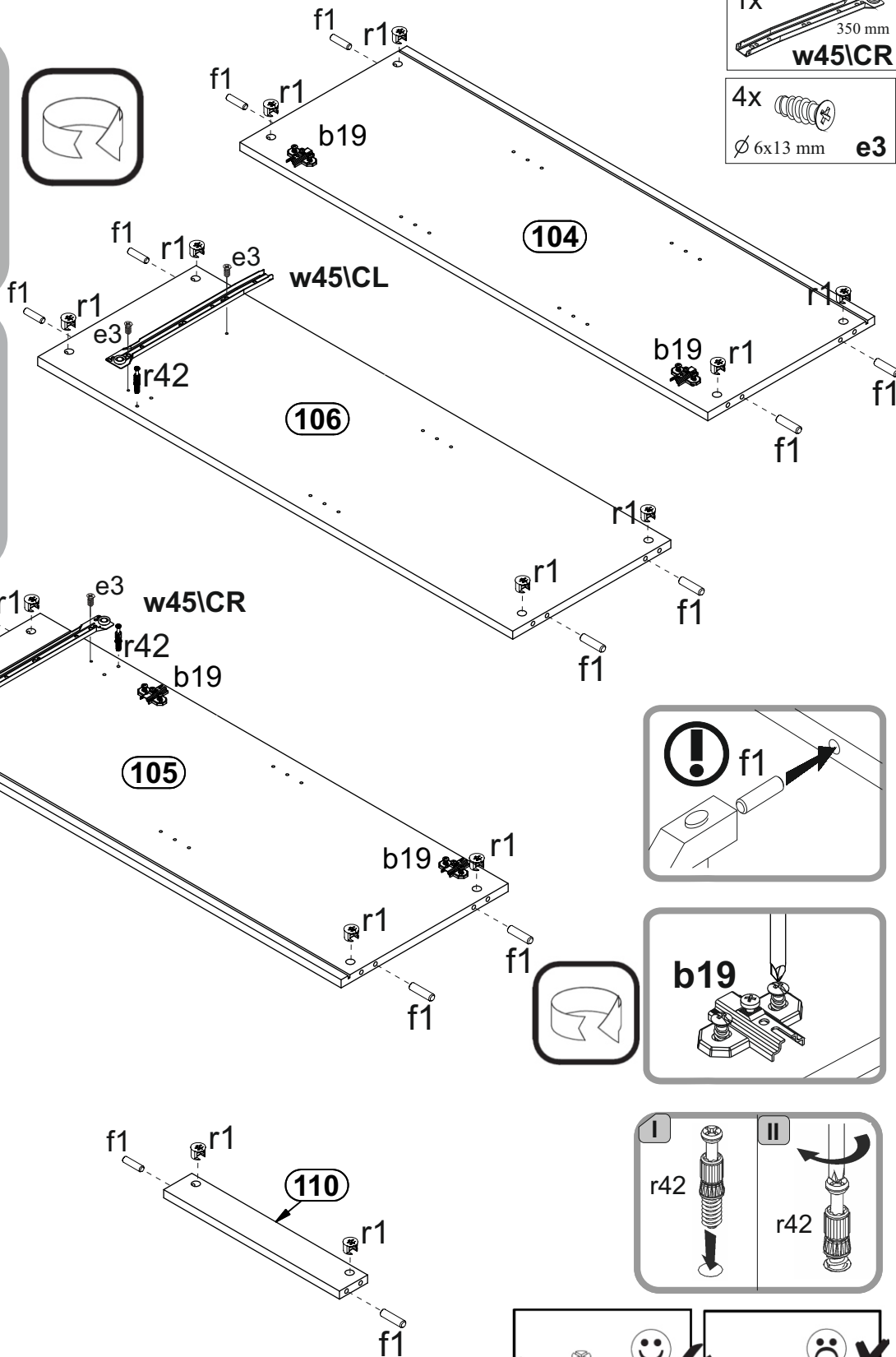
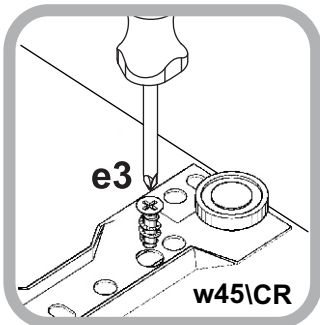
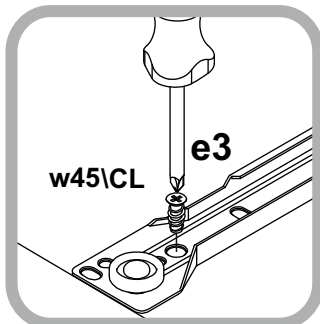
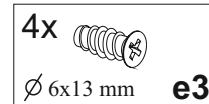
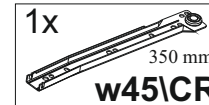
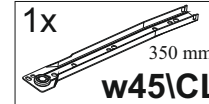
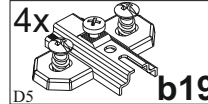
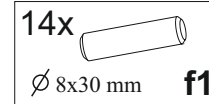
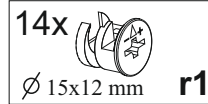
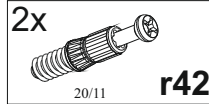
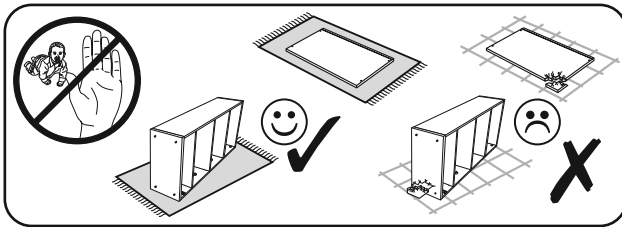

# 2

12x  
20/11  
**r42**

5x  
**k27**

5x  
 $\varnothing 4 \times 30 \text{ mm}$   
**p9**

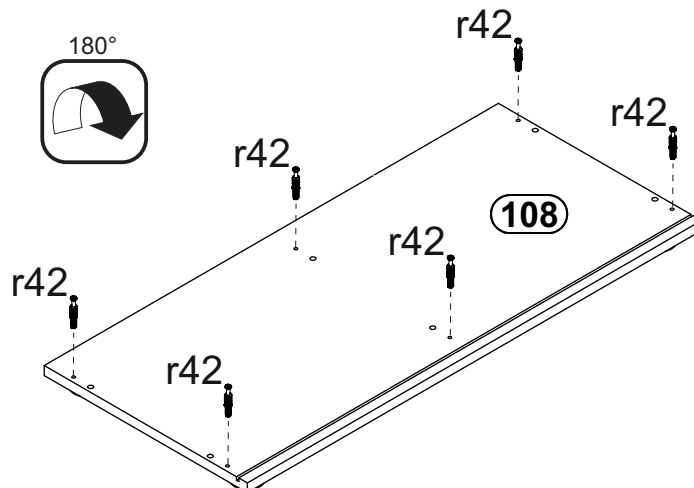
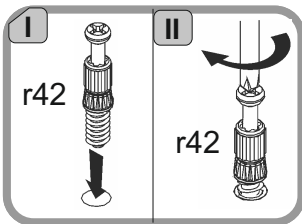
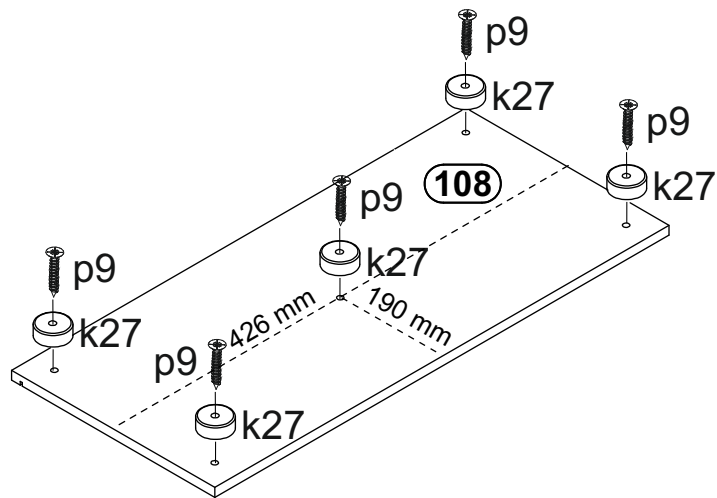
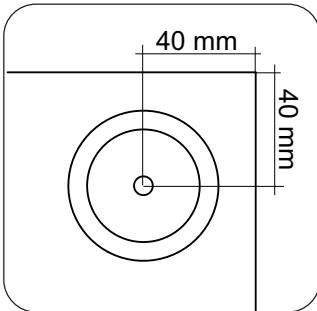
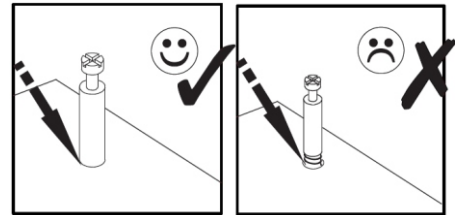
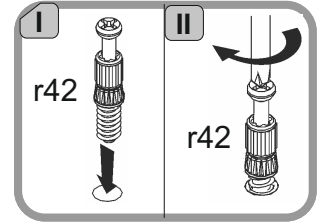
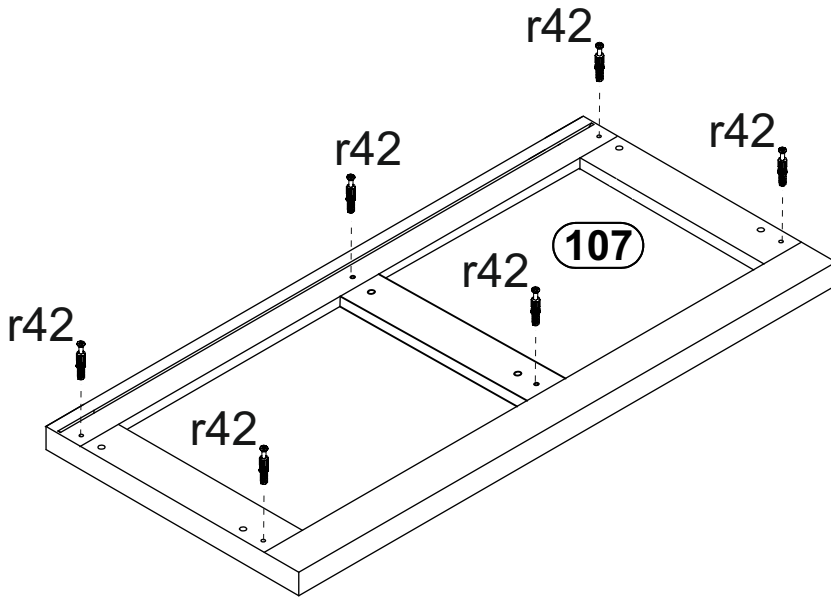



# 3

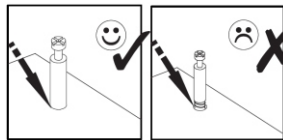
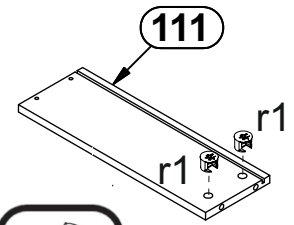
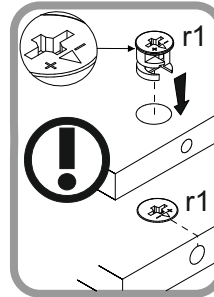
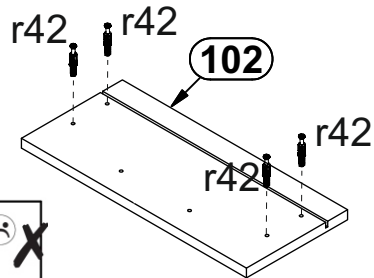
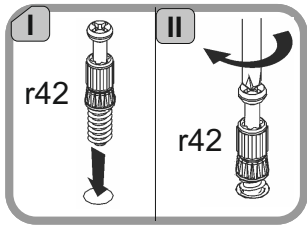
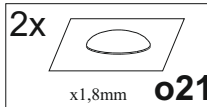
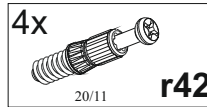
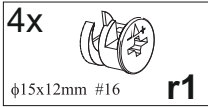
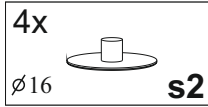
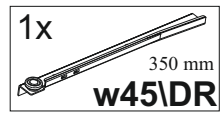
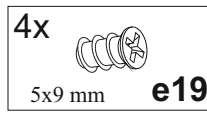
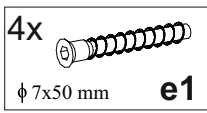
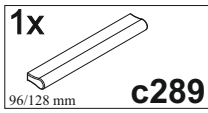
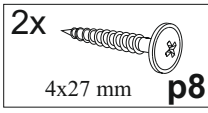
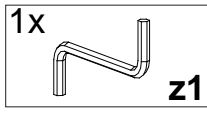

## A

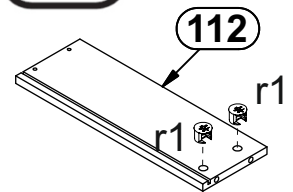
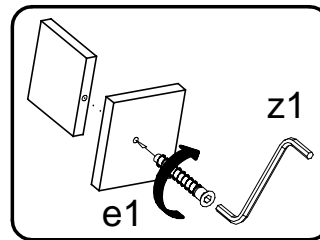
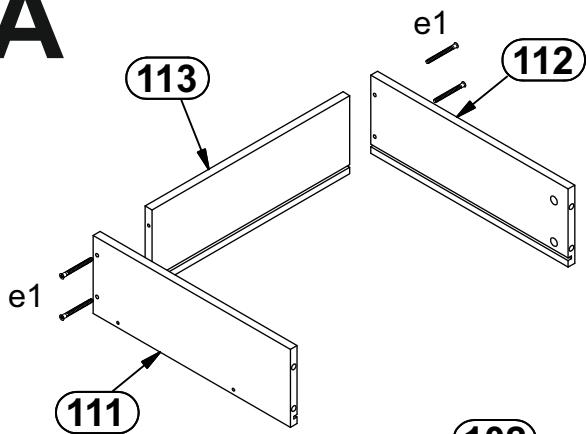

## B

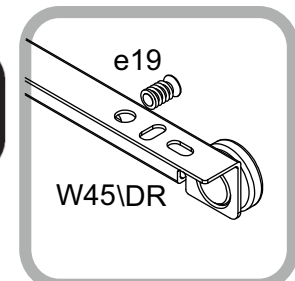
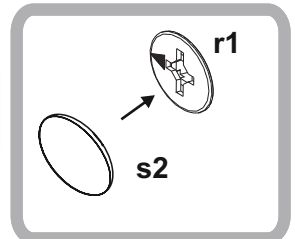
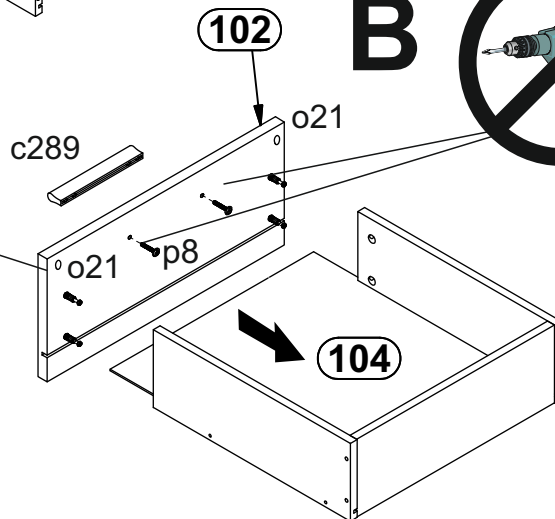
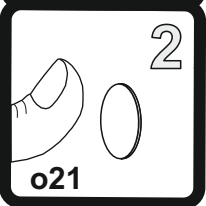
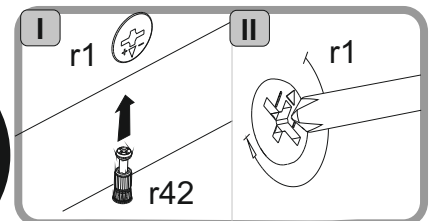
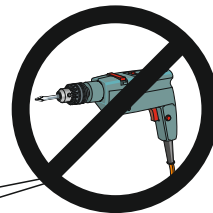

## C

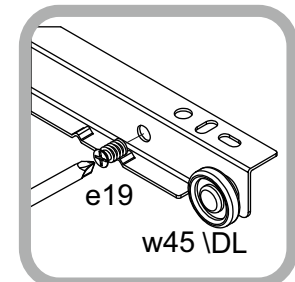
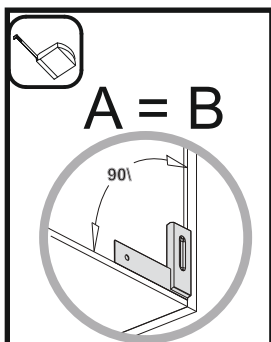
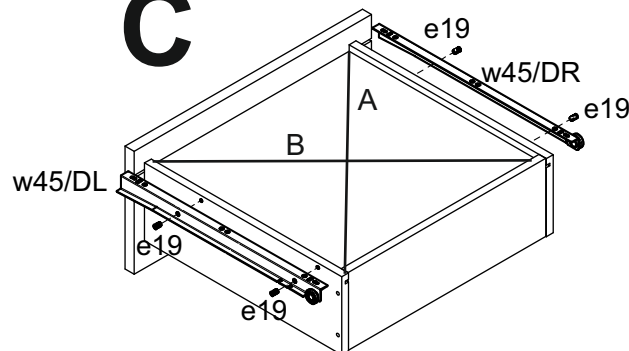

# 4

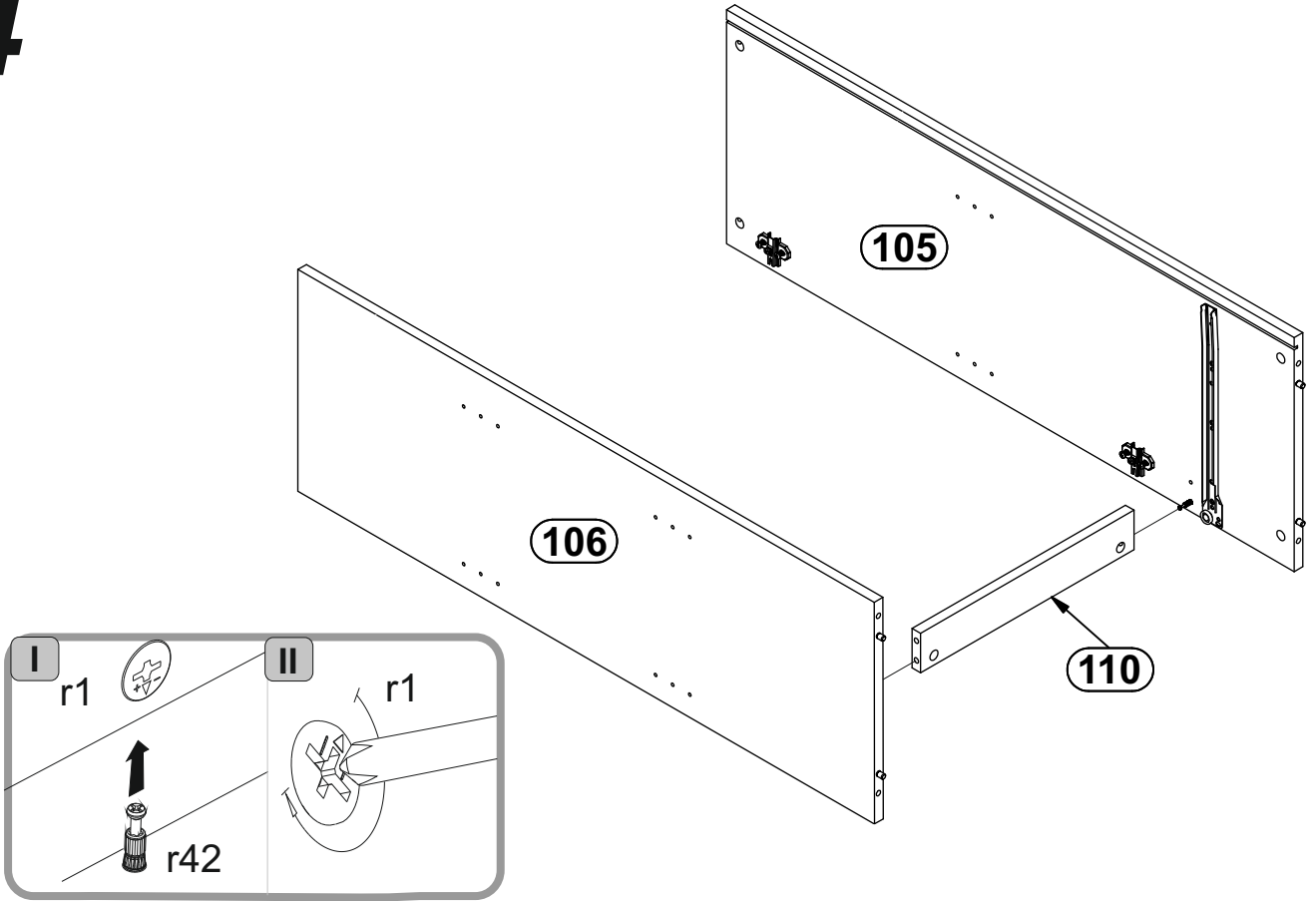

# 5

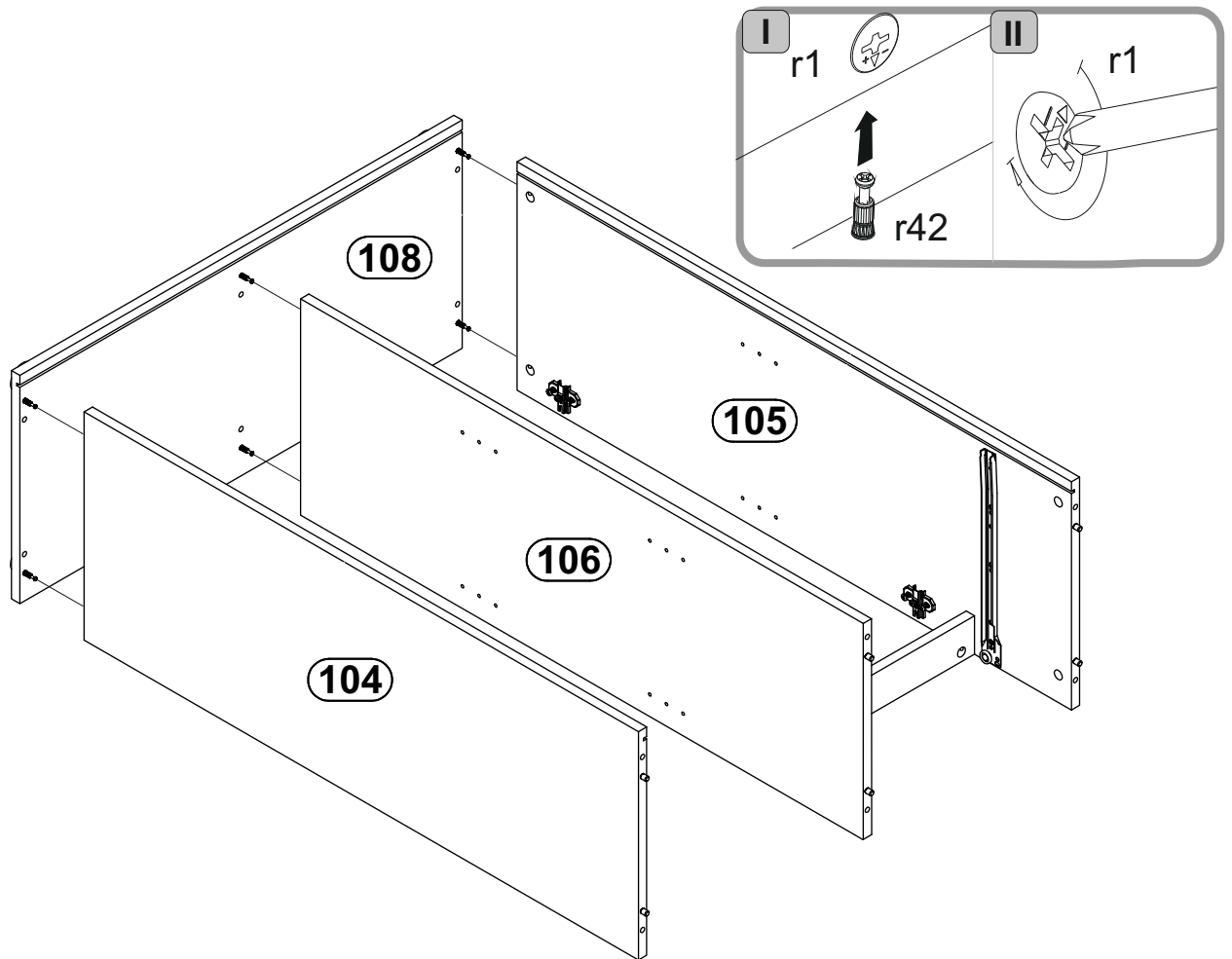

# 6

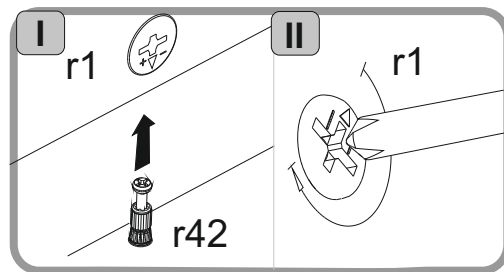
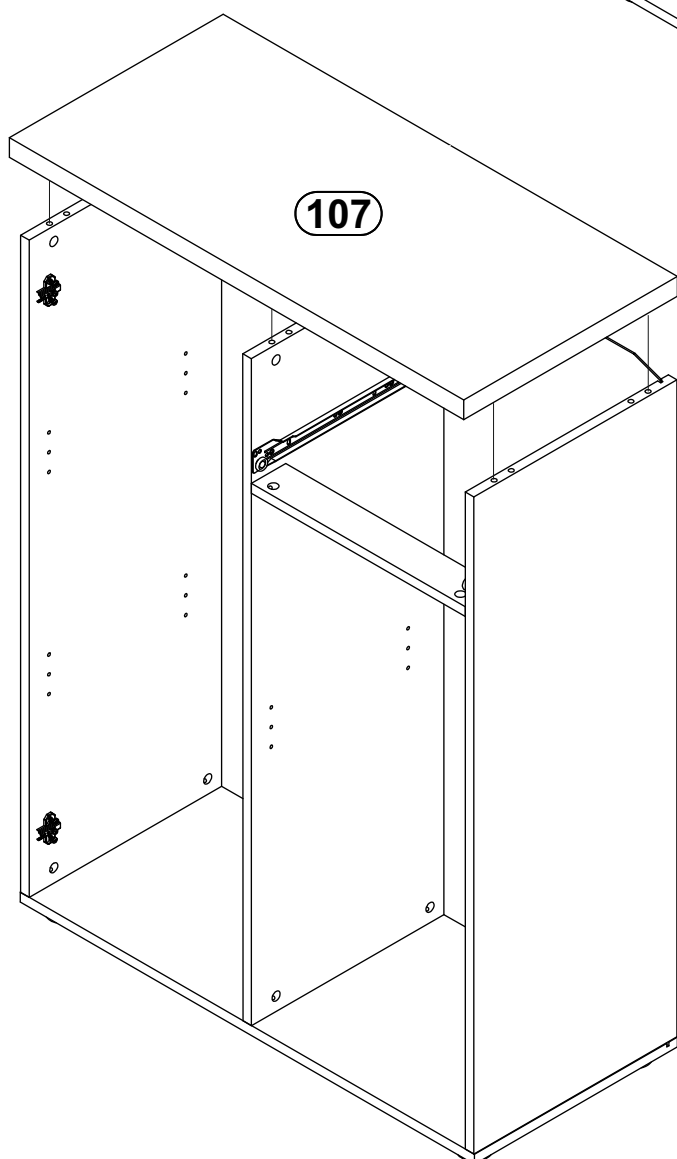
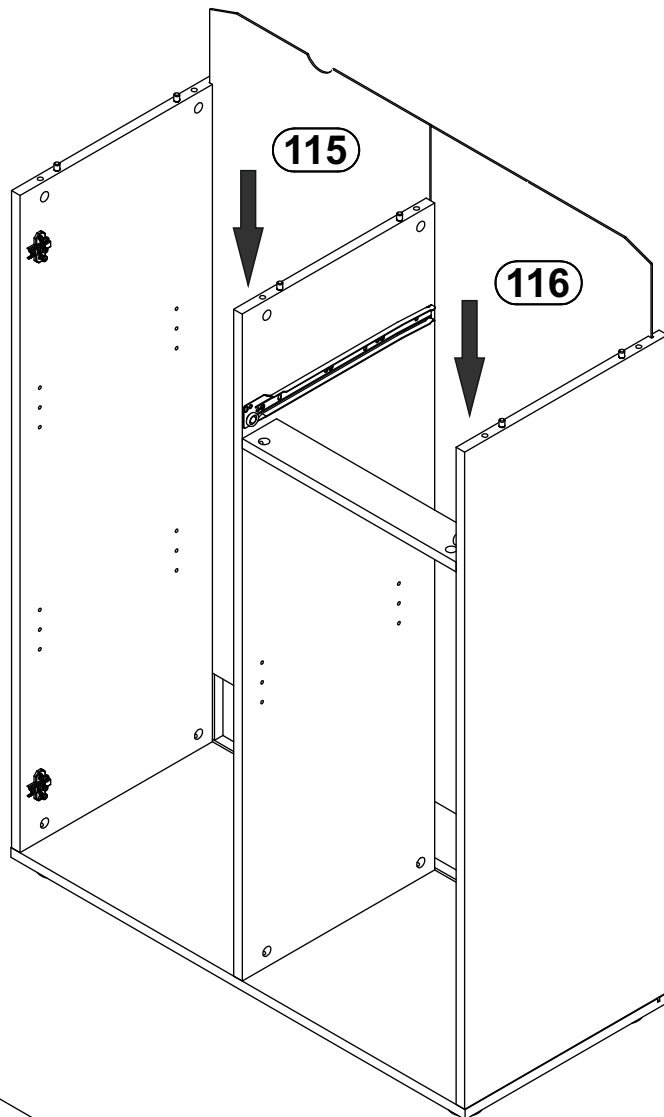

# 7

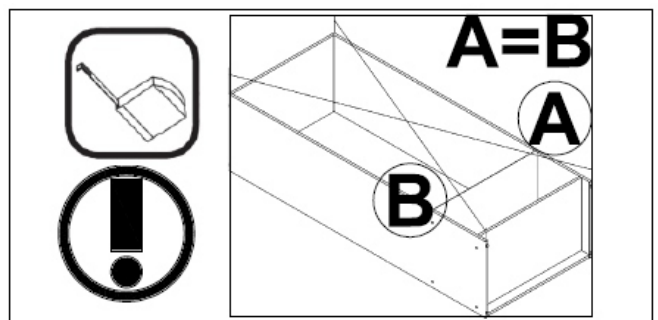
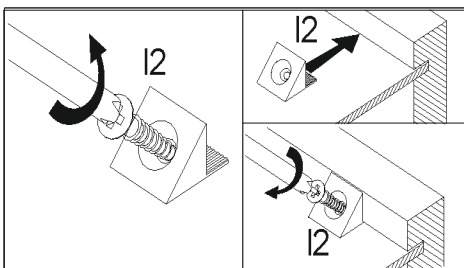
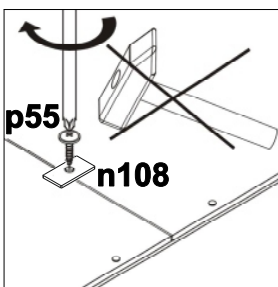
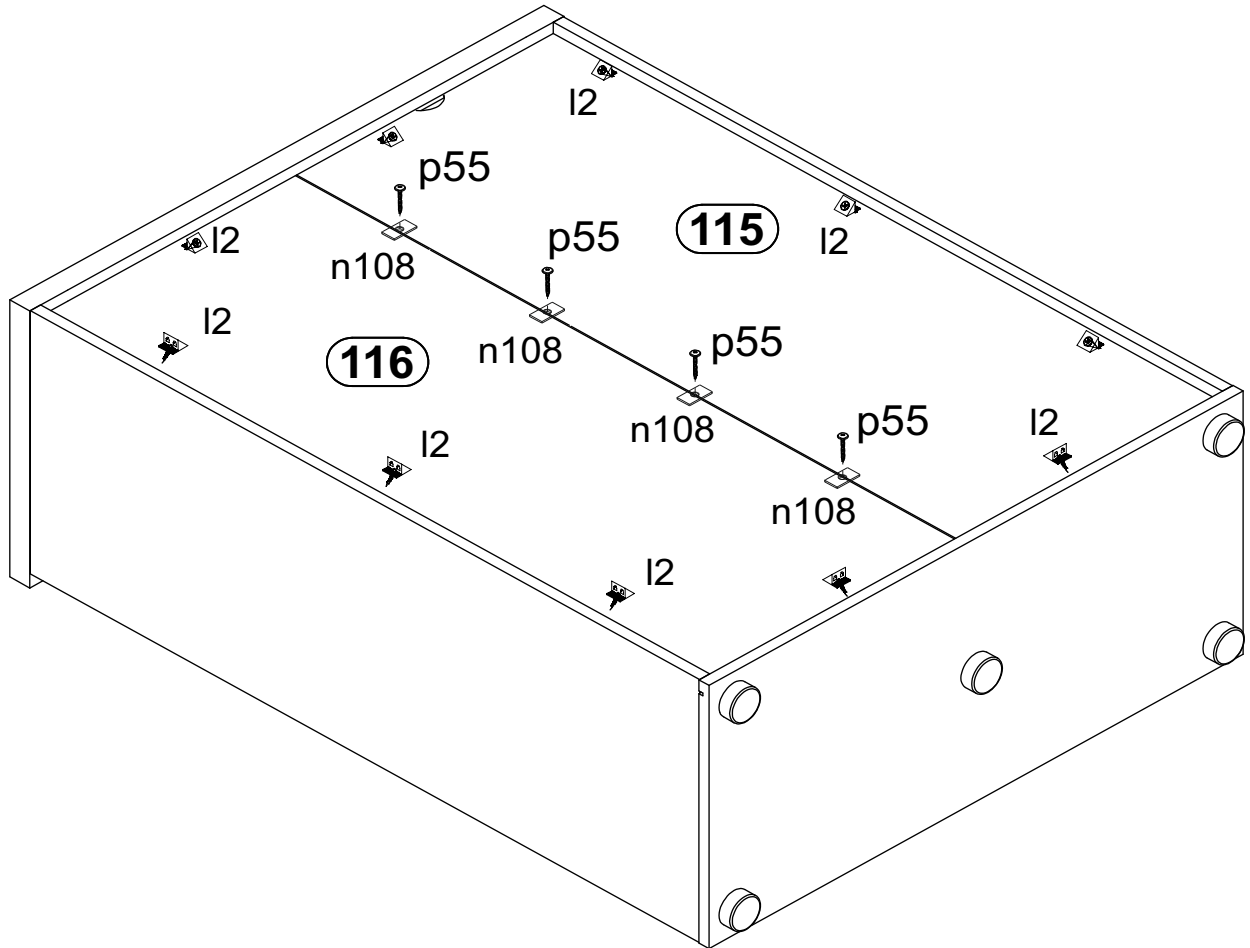
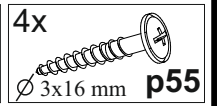
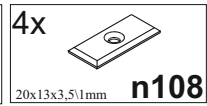
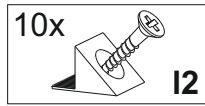

# 8

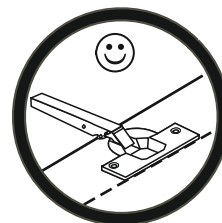
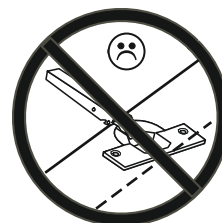
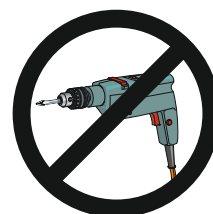
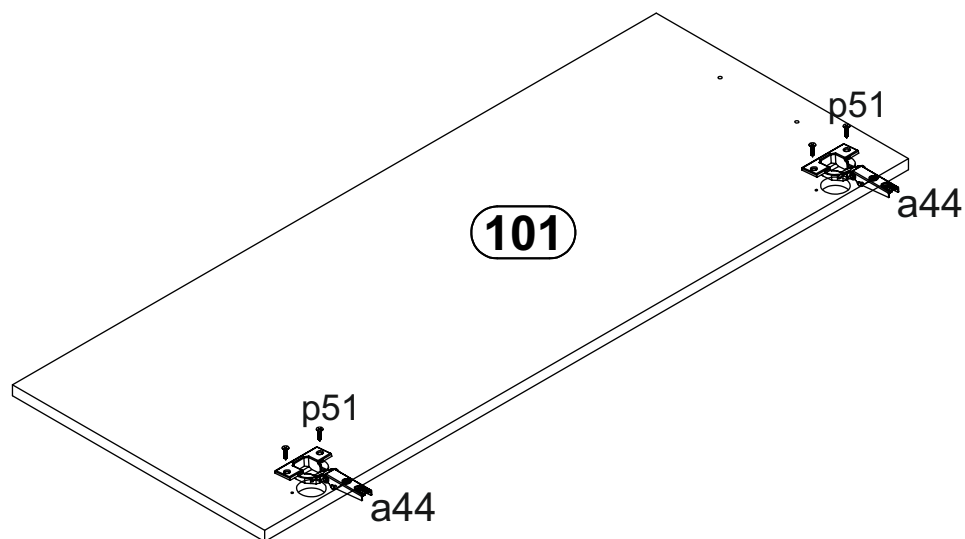
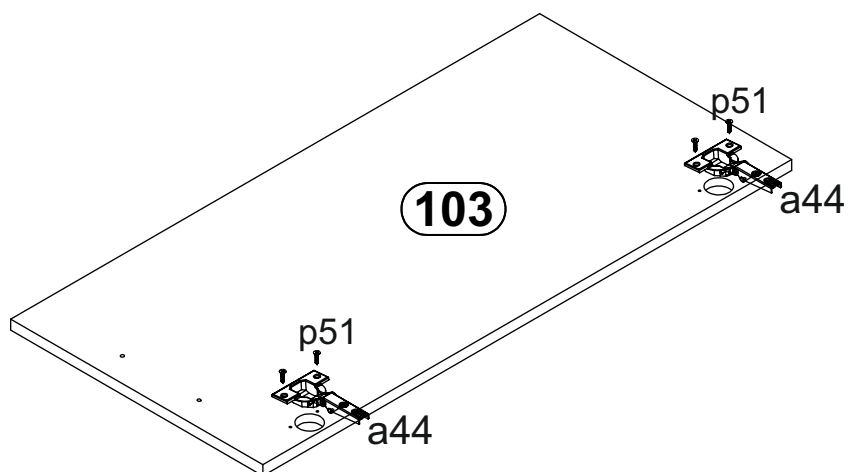
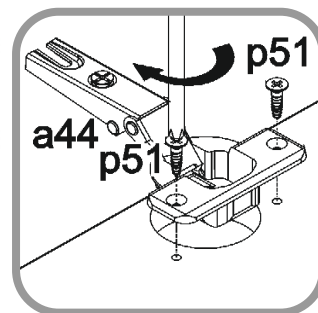
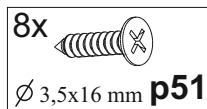
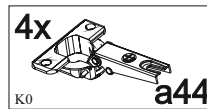
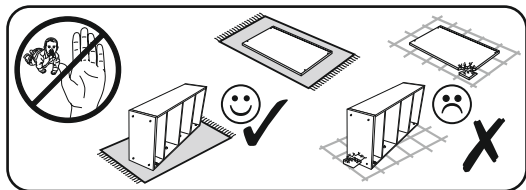

# 9

14x  
∅ 16  
s2

12x  
∅ 5x17 mm  
d1

2x  
96/128 mm  
c289

4x  
∅ 4x27 mm  
p8

4x  
∅ 8x1,8 mm  
o21

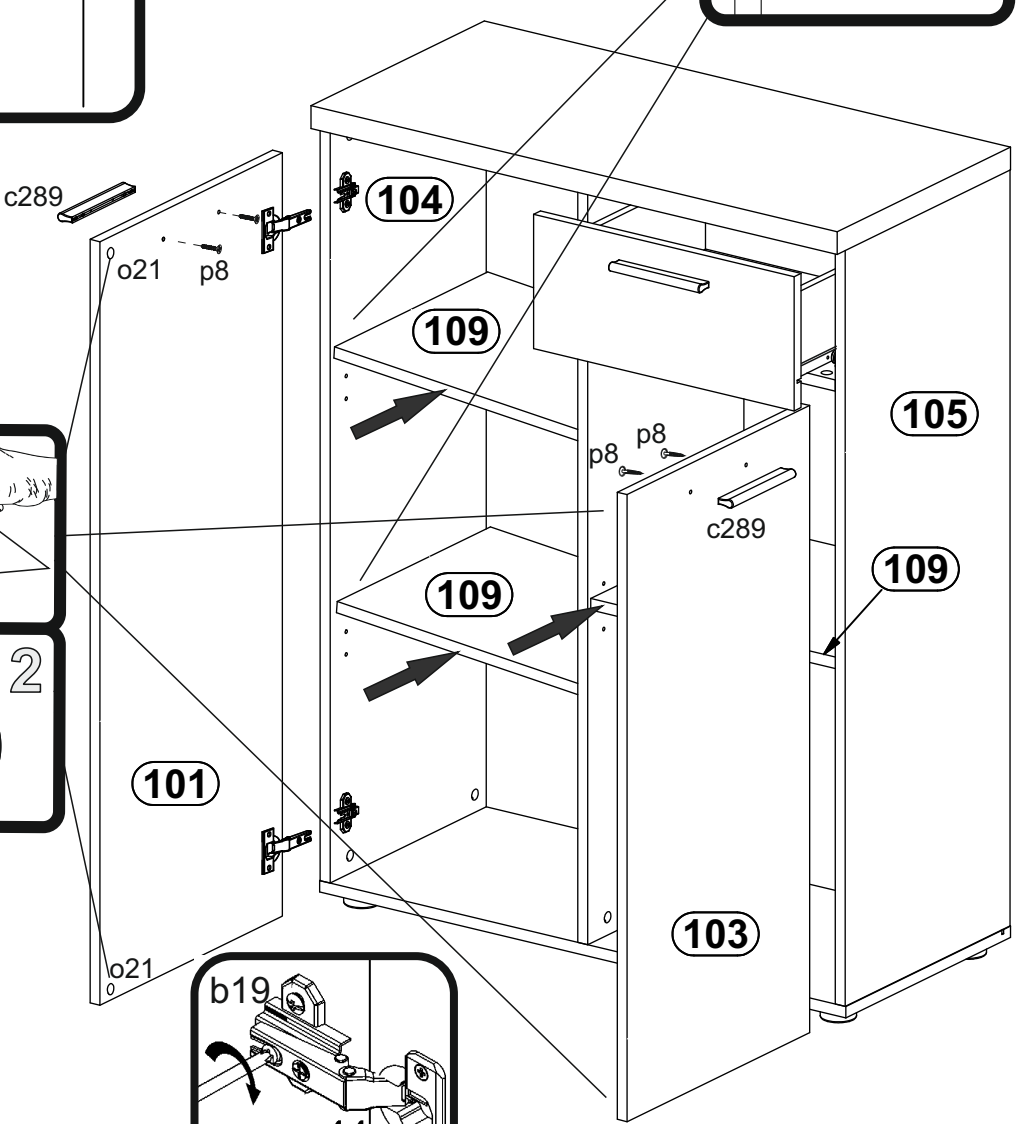
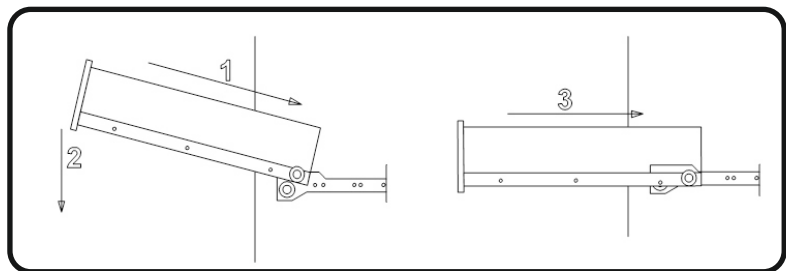
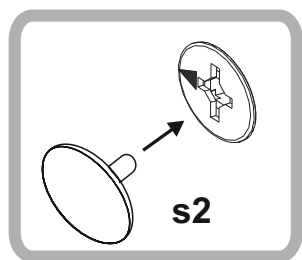
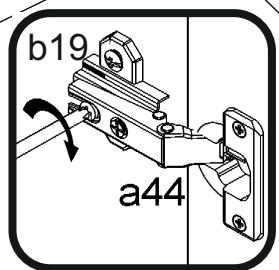
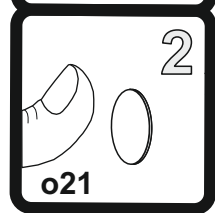
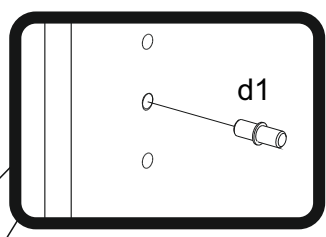
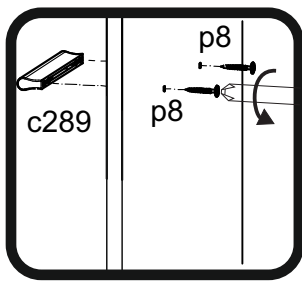

# 10

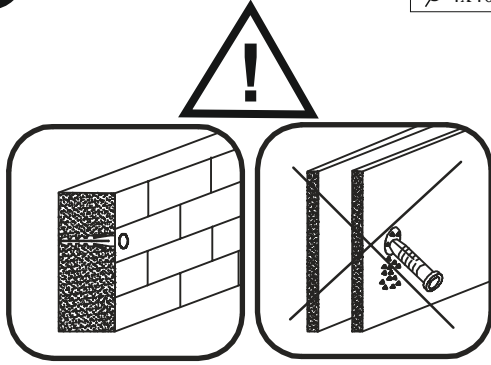
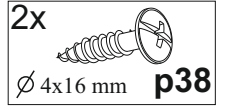
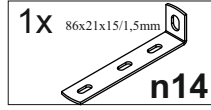
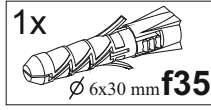
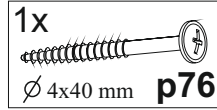

**A**

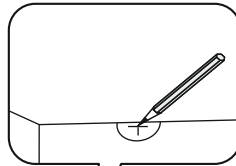

**B**

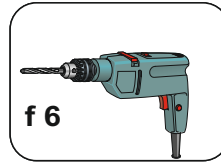

**C**

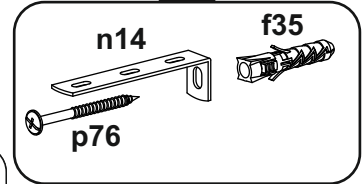

**D**

