

Kuchyně Brick Light - 260 cm

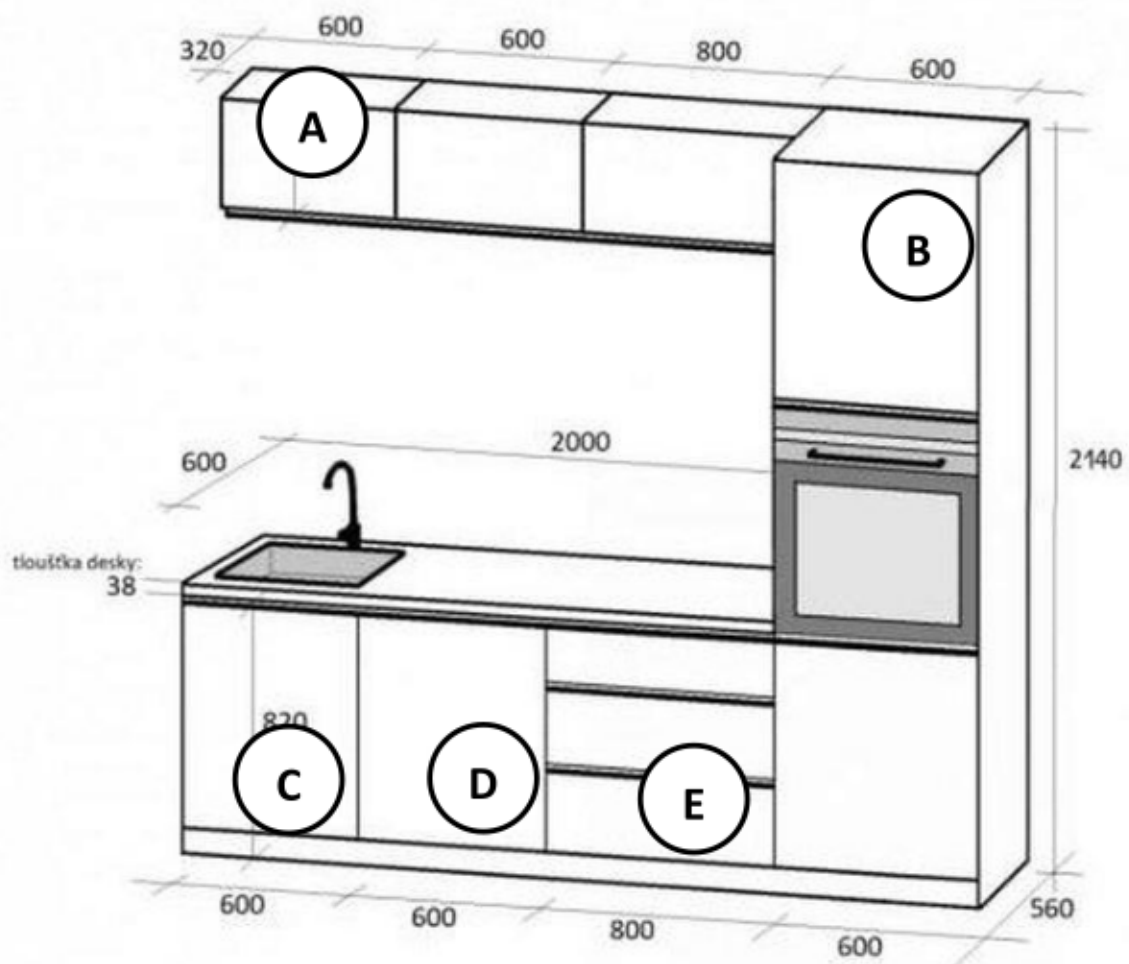

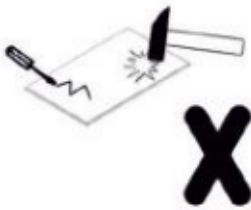

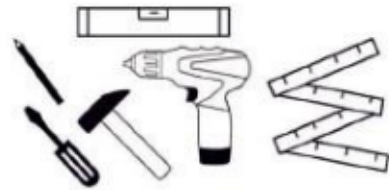

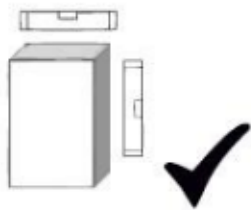
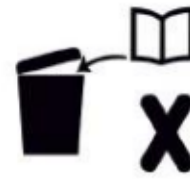
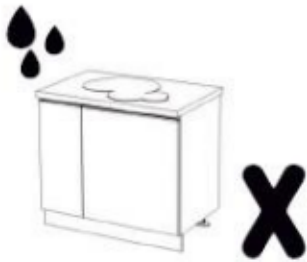
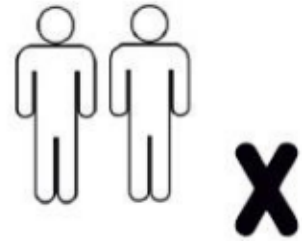
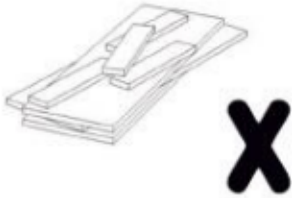
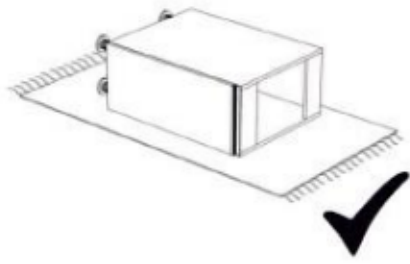

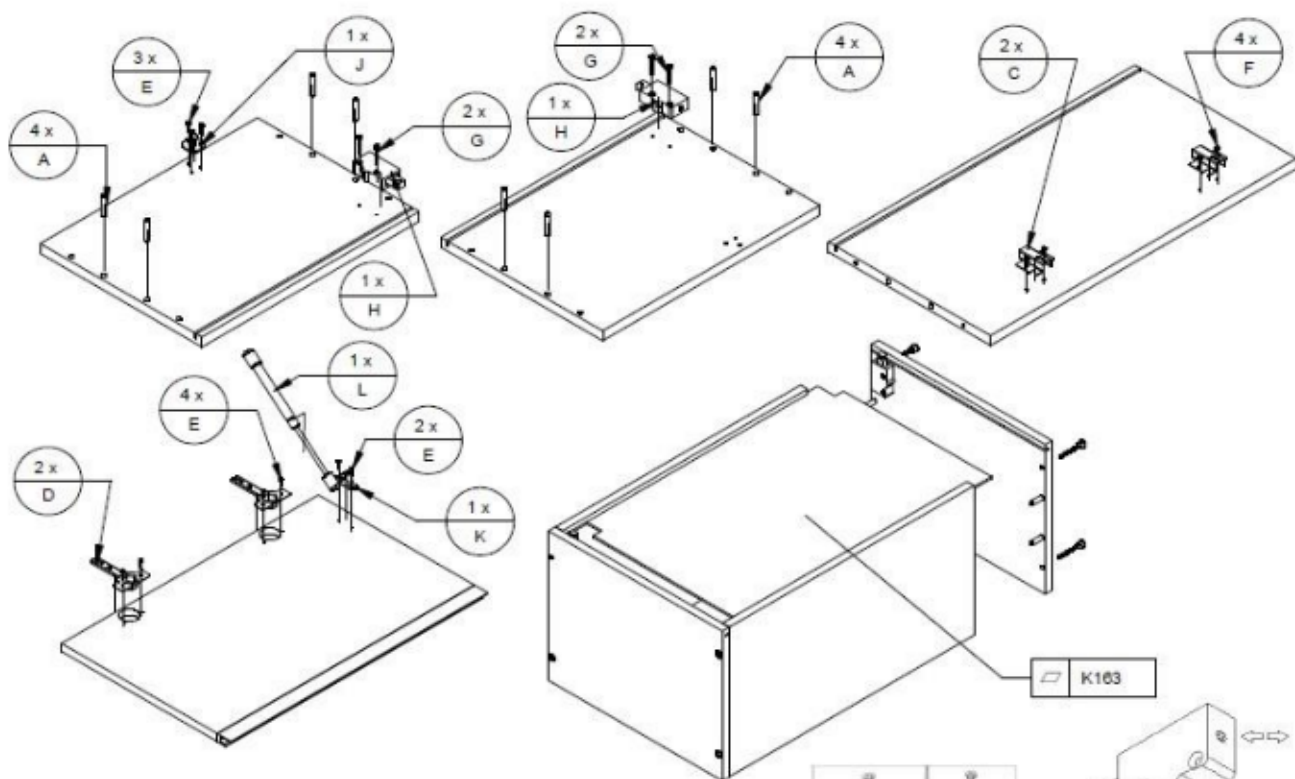





A

G50/60 ok



A	B	C
 x8	 x8	 x2
D	E	F
 x2	 $\varnothing 3,5$ x9	 $\varnothing 4$ x4
G	H	J
 $\varnothing 4$ x4	 x2	 x1
K	L	
 x1	 x1	

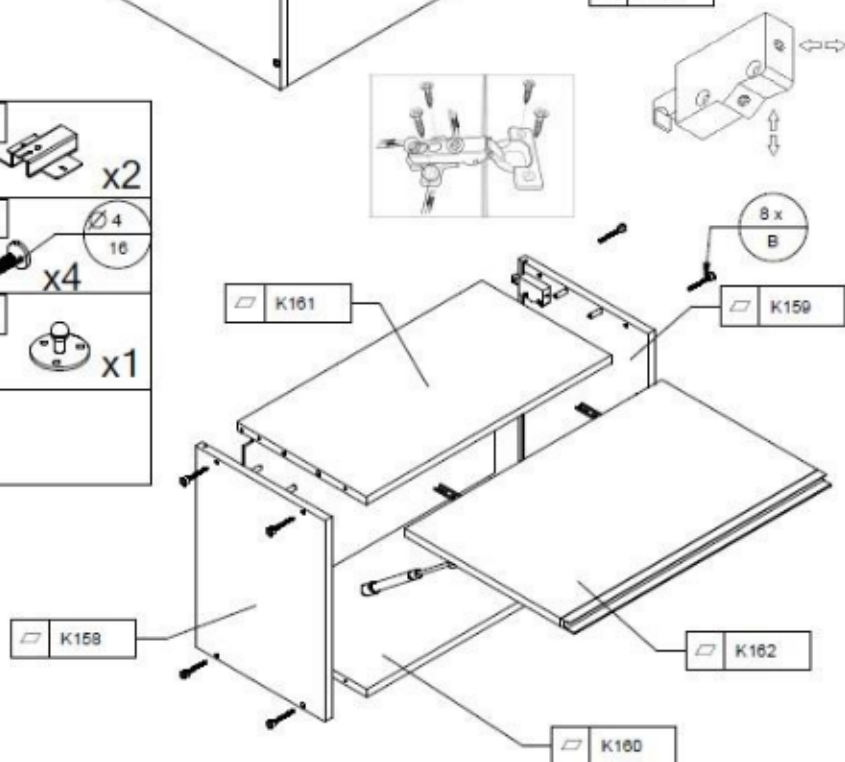

B



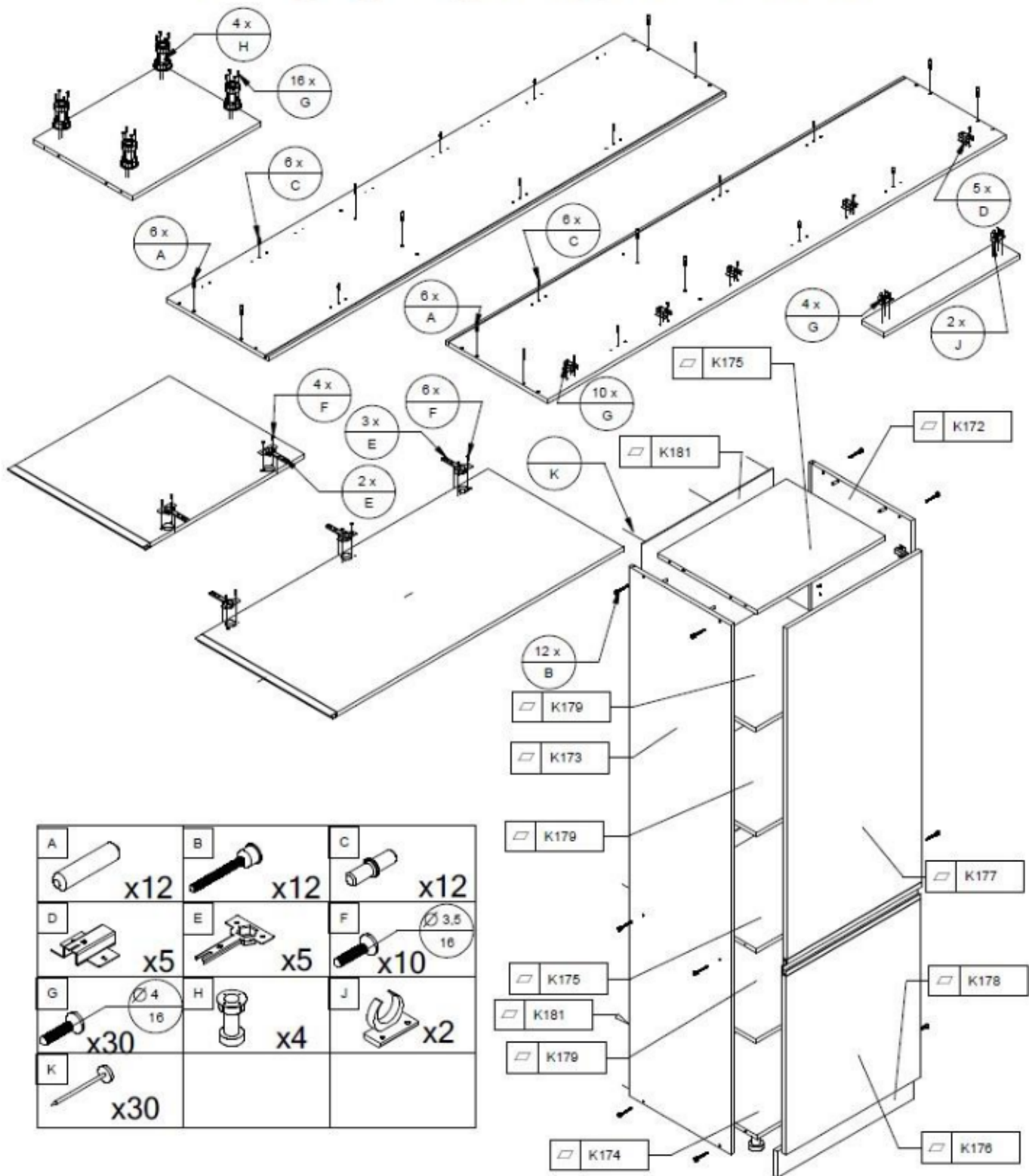





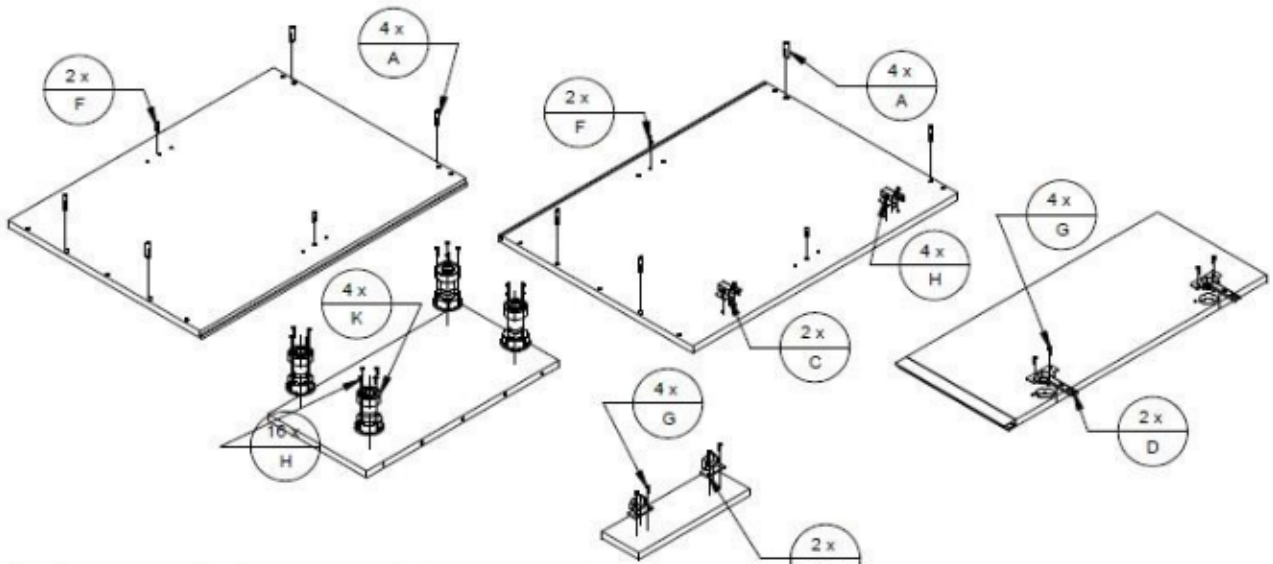

D60 SŁUPEK



C D

D 30/40/60 1F



A	B	C
 x8	 x10	 x2
D	E	F
 x2	 x2	 x4
G	H	J
 x8	 x20	 x20
K		
 x4		

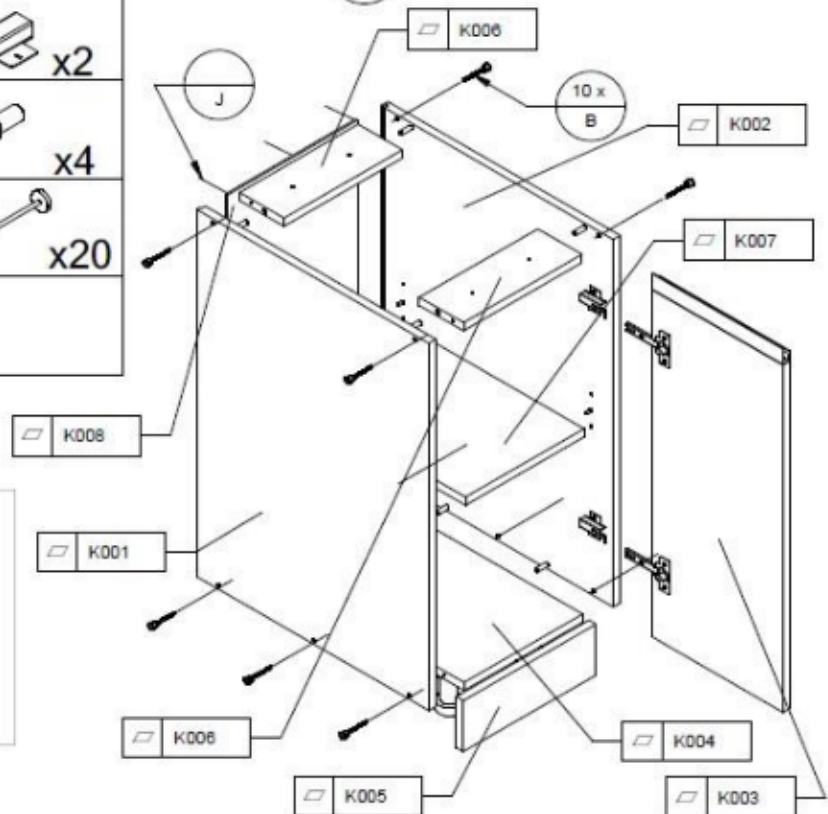
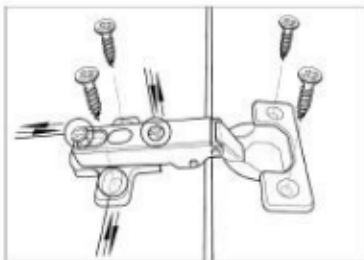

E

D 60 3sz/80 3sz

