

Rohová kuchyně Brick 300x182

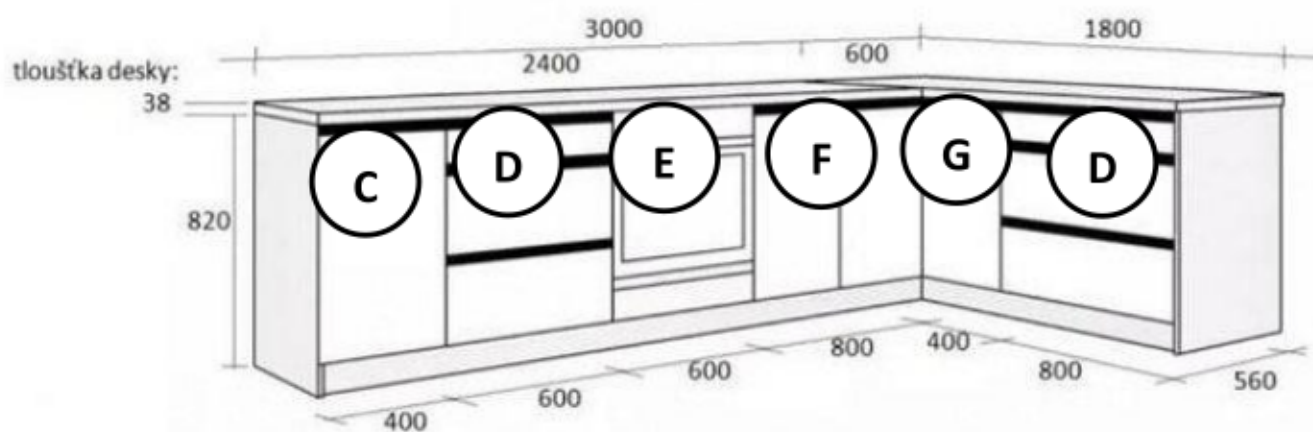

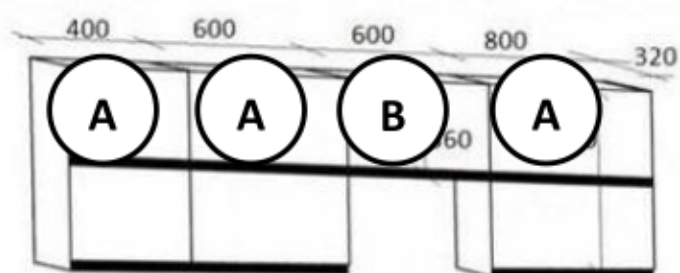

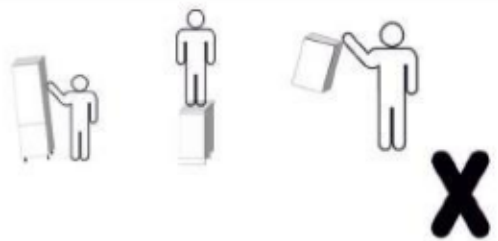

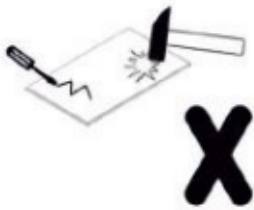
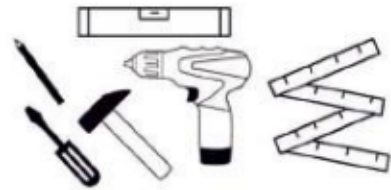
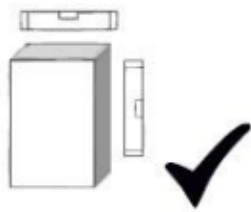
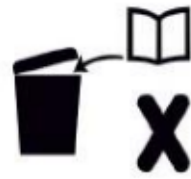
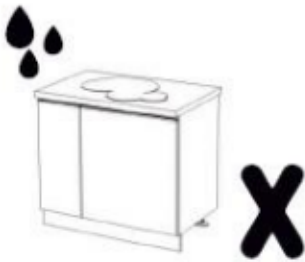
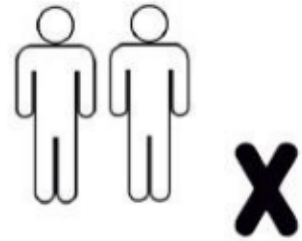
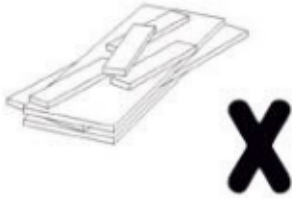
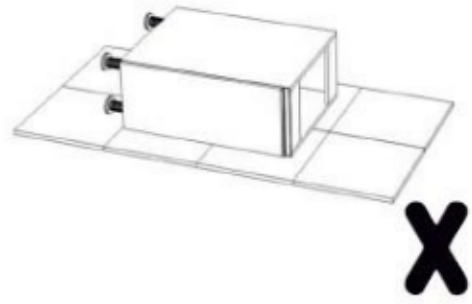
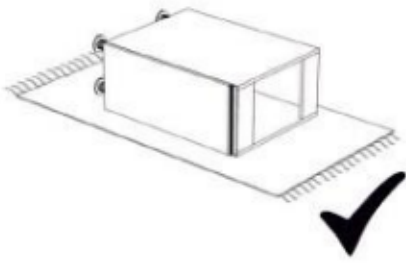

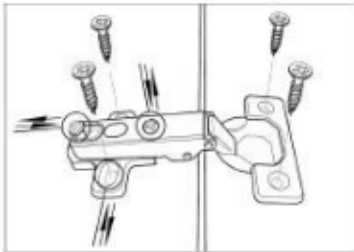
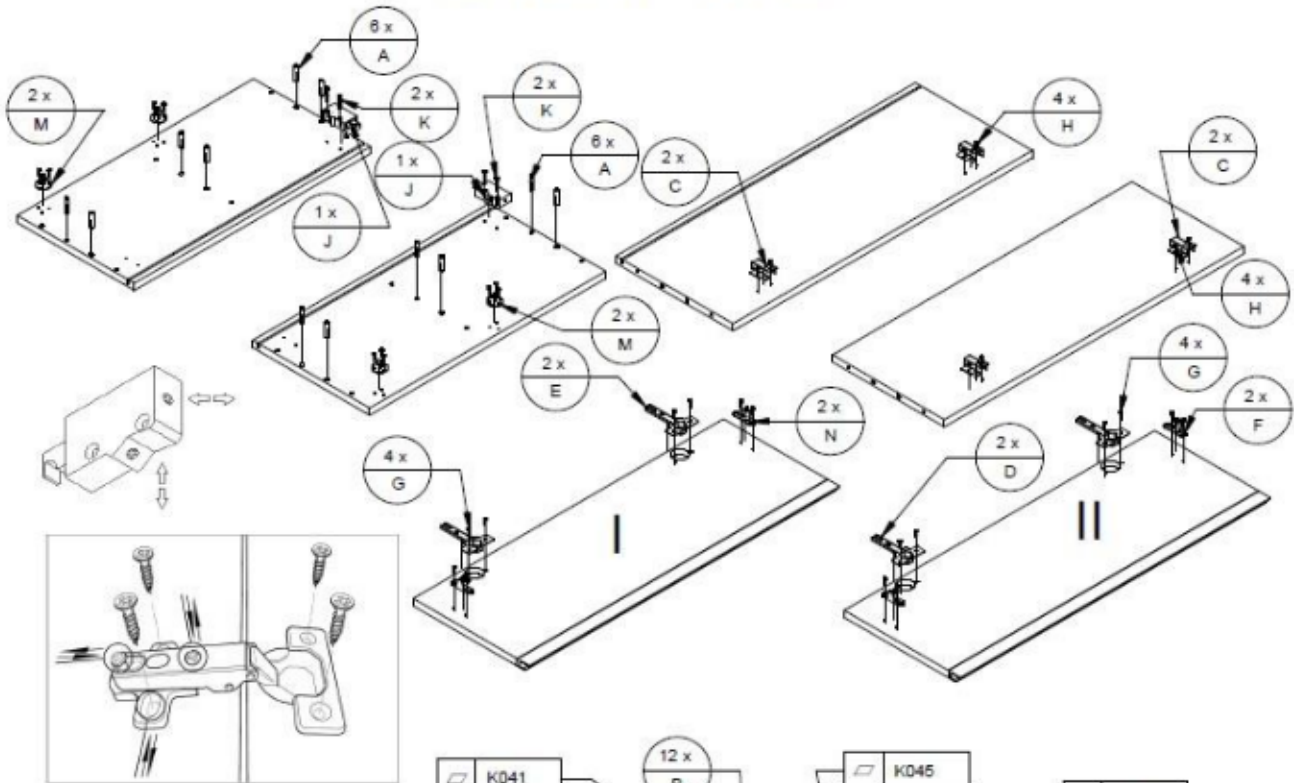







A

G60u/80u



A	B	C
 x12	 x12	 x4
D	E	F
 x2	 x2	 x4
G	H	J
 $\varnothing 3.5$ 16 x8	 $\varnothing 4$ 16 x8	 x2
K	L	M
 $\varnothing 4$ 30 x4	 x4	 x4

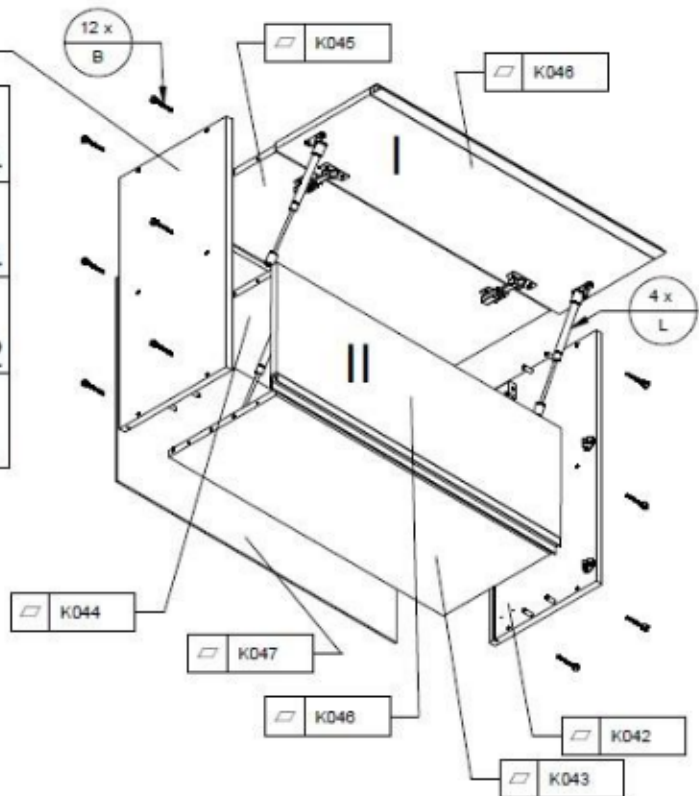

B

G50/60 ok

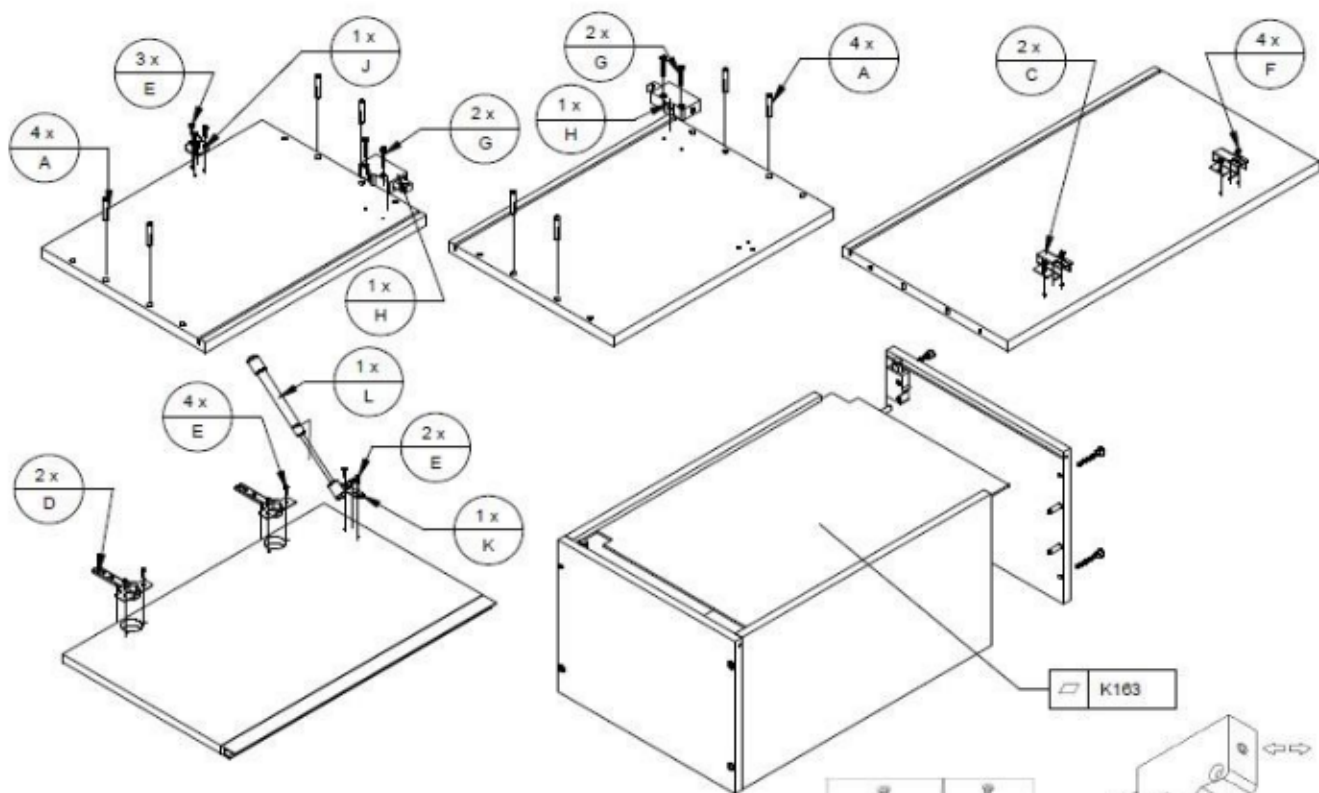



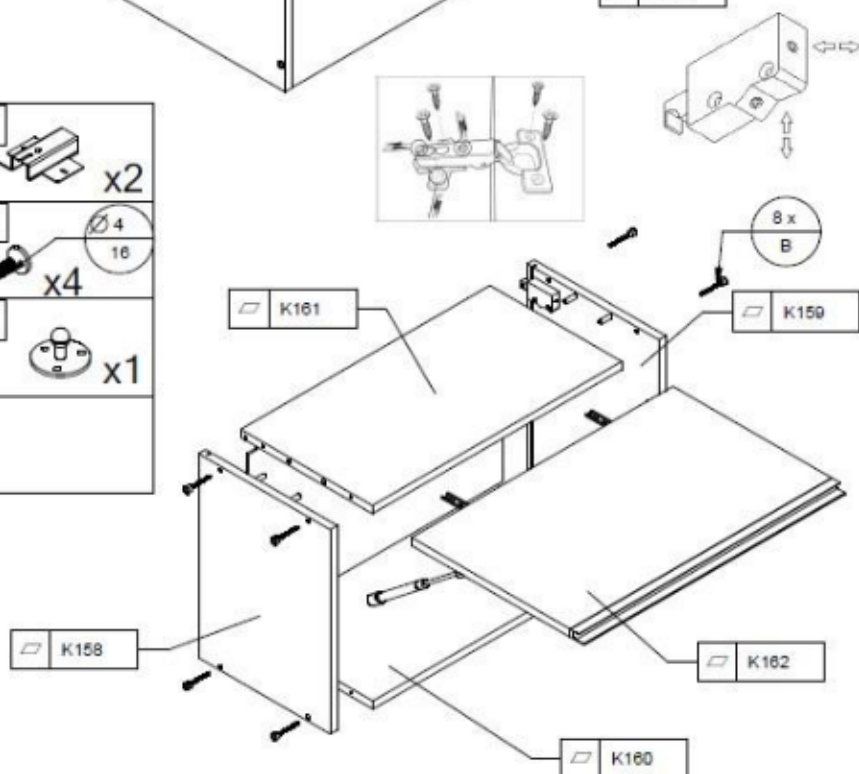





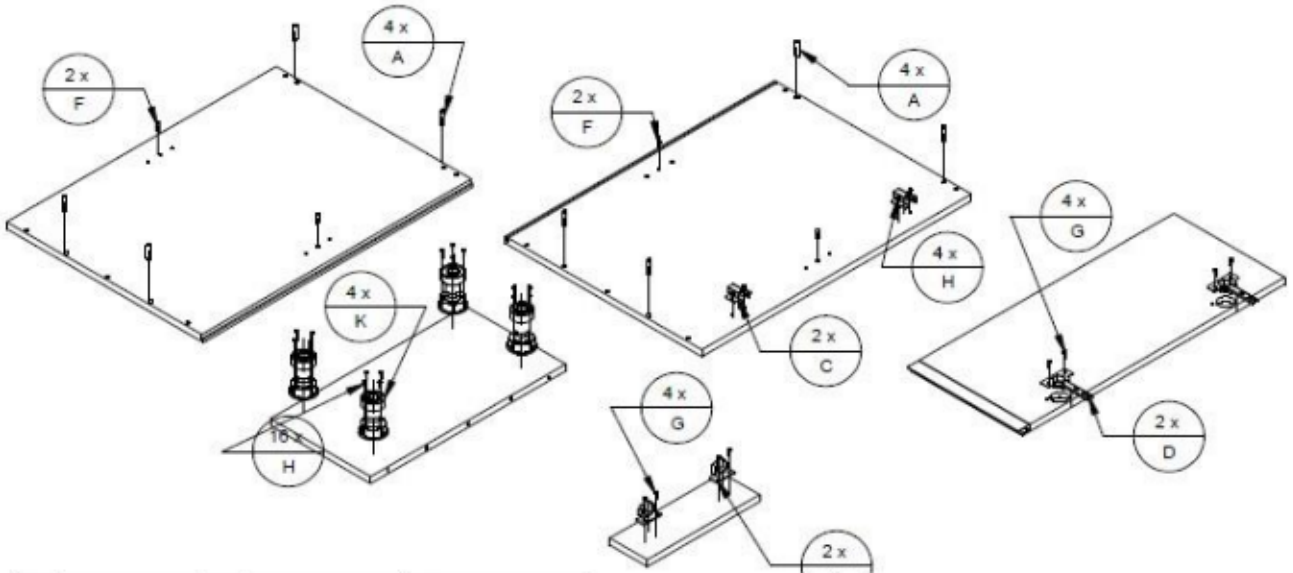

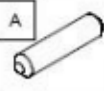
A	x8	B	x8	C	x2
D	x2	E	x9	F	x4
G	x4	H	x2	J	x1
K	x1	L	x1		

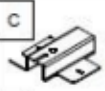



D 30/40/60 1F



 A x8	 B x10	 C x2
 D x2	 E x2	 F x4
 G x8 $\varnothing 3.5$ 16	 H x20 $\varnothing 4$ 16	 J x20
 K x4		

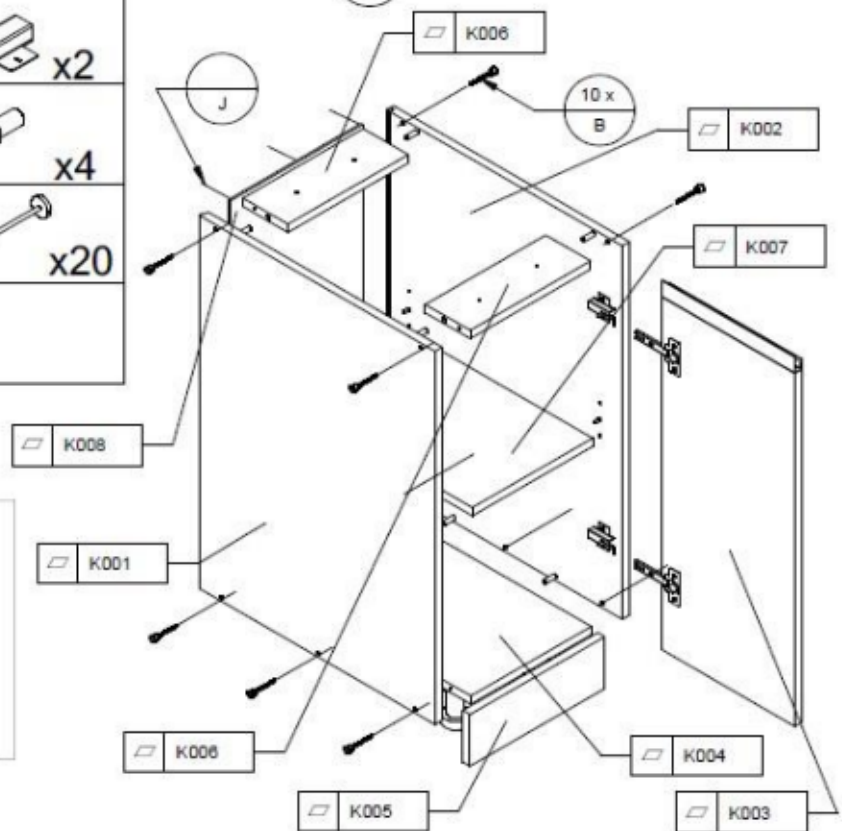
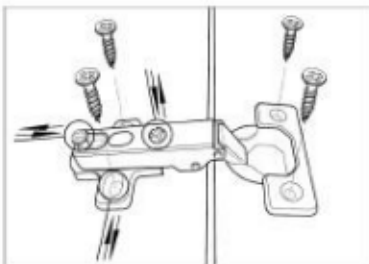

D



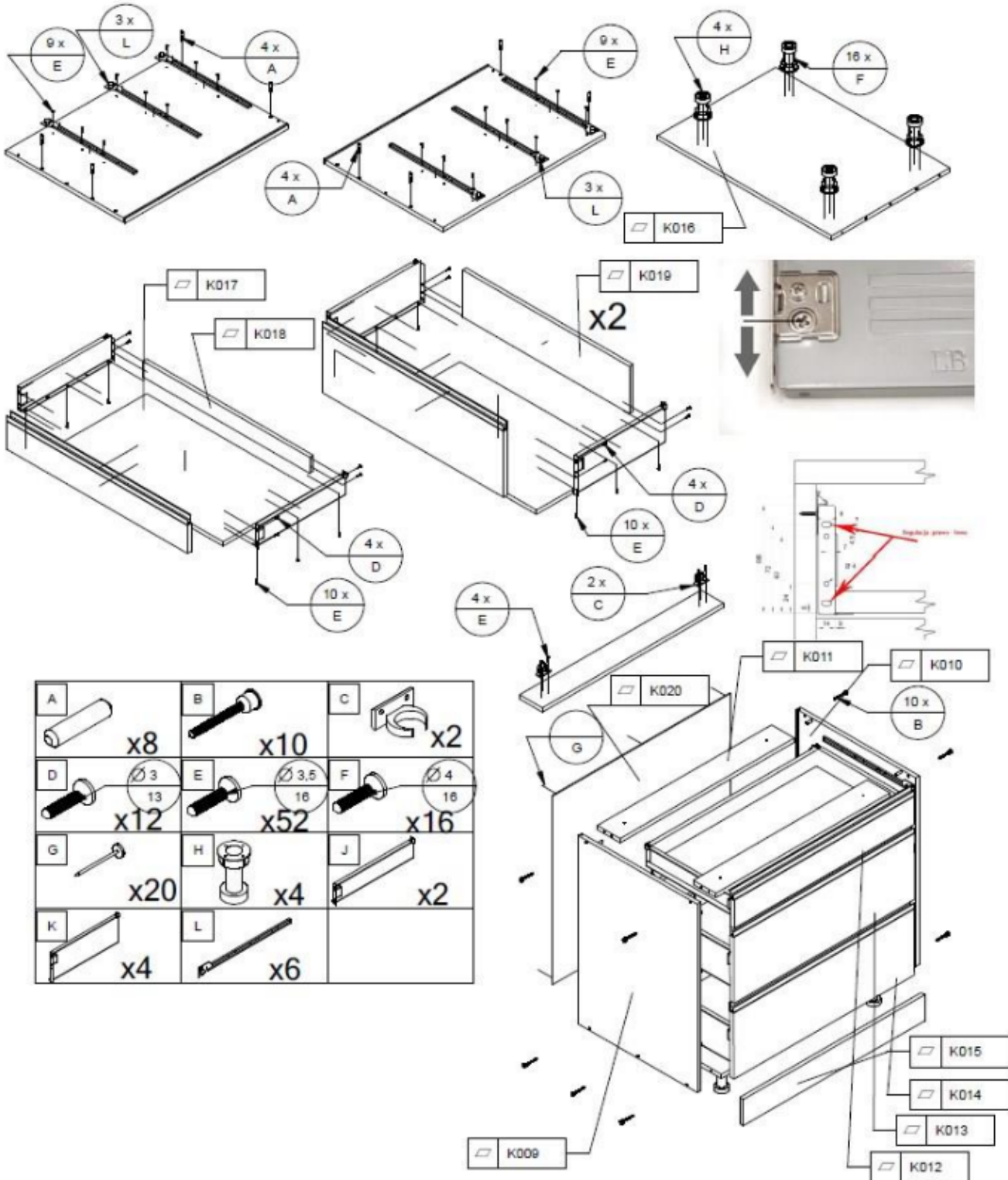



D 60 3sz/80 3sz

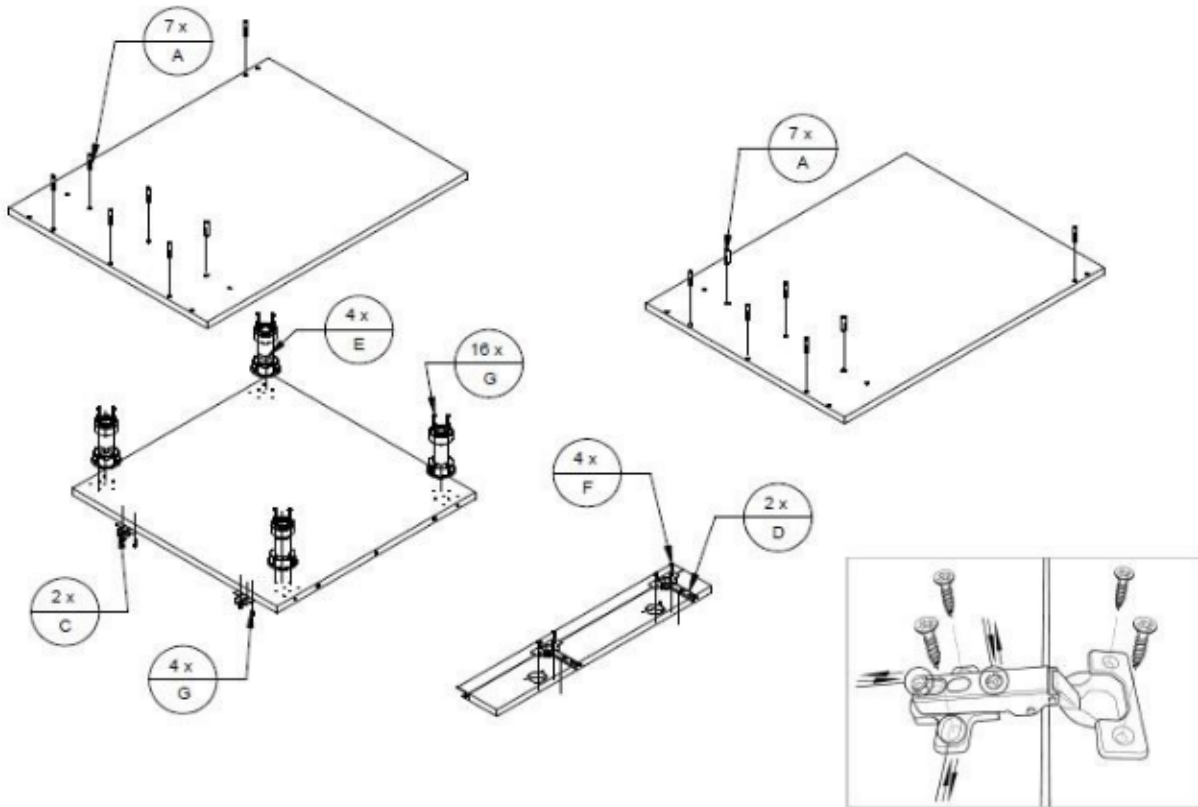

E

D 60 ku





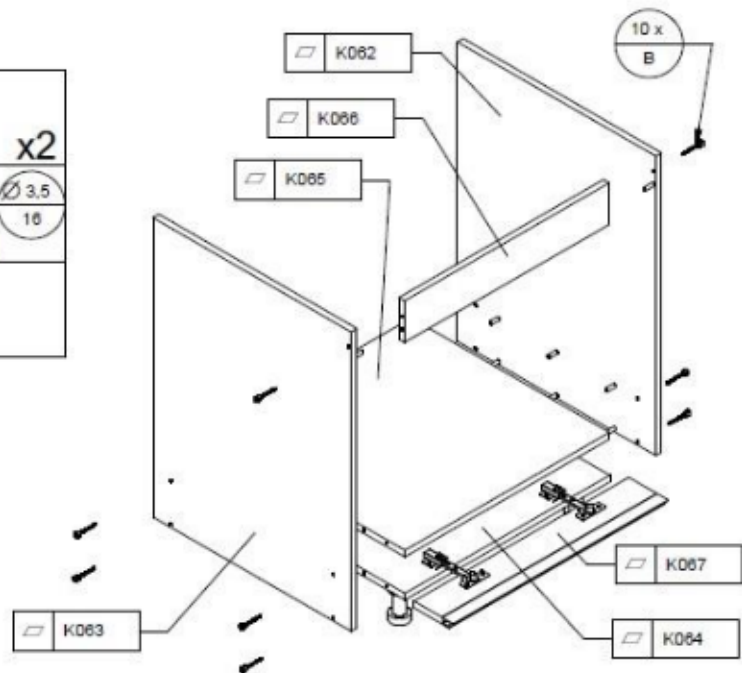





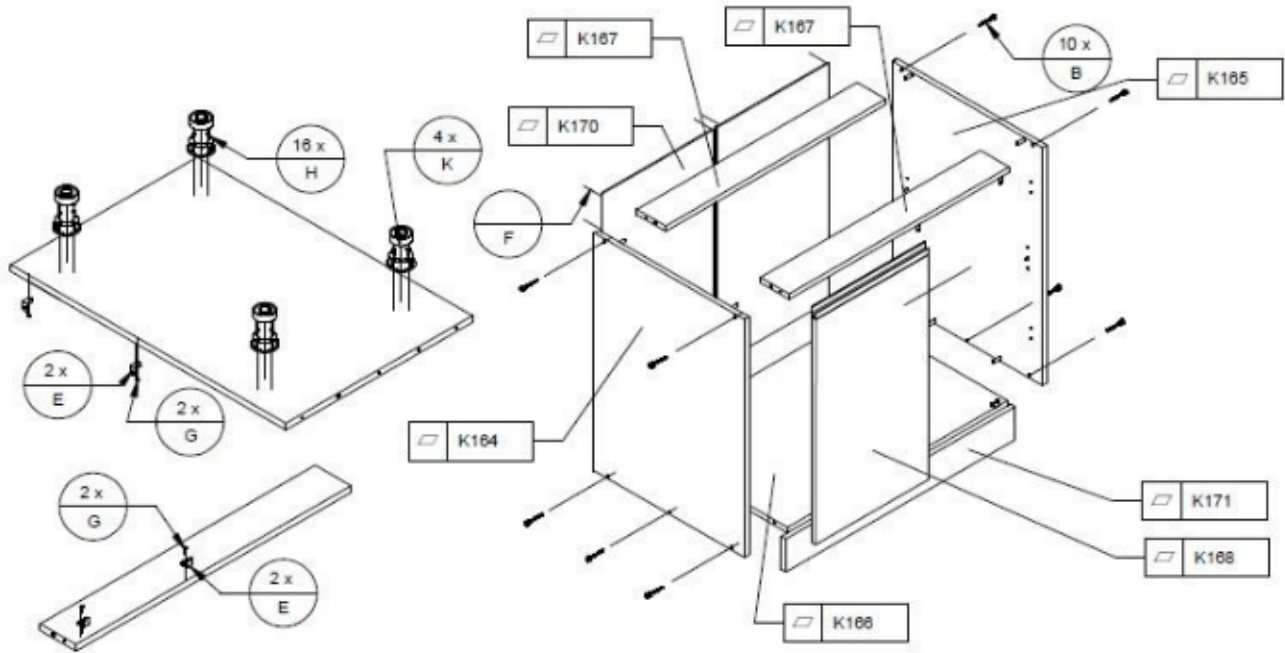
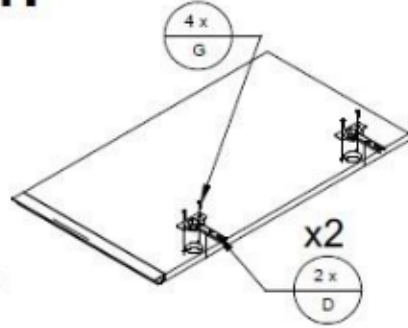
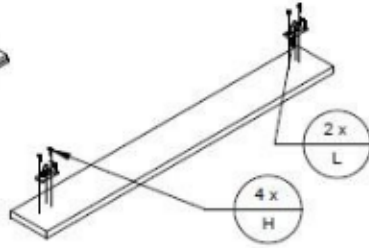
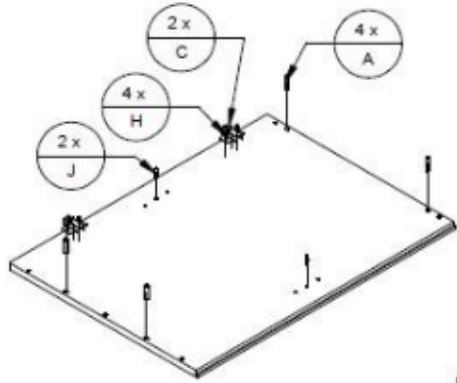



A	 x14	B	 x10	C	 x2
D	 x2	E	 x4	F	 x4 $\begin{matrix} \text{3,5} \\ \text{16} \end{matrix}$
G	 x20 $\begin{matrix} \text{4} \\ \text{16} \end{matrix}$				



G

D 80zaśl.



A	 x8	B	 x10	C	 x2	D	 x2	E	 x4
F	 x35	G	 3.5 x 16 x12	H	 4 x 16 x24	J	 x4	K	 x4
L	 x2								

F

D 80zi

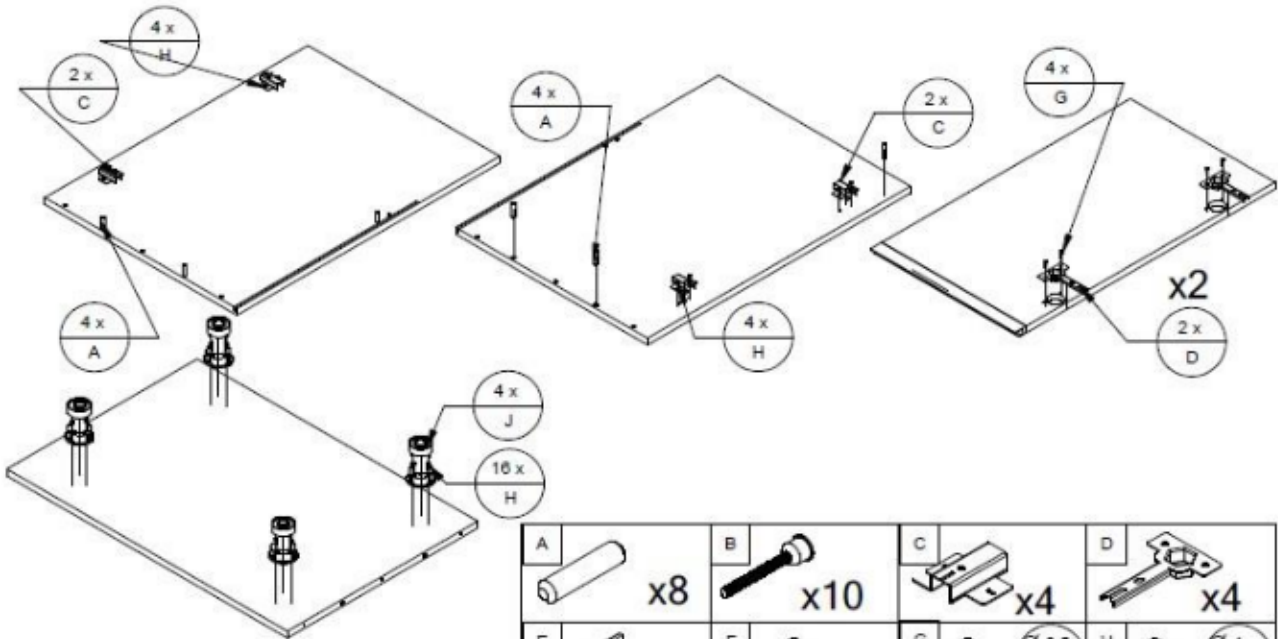

A	x8	B	x10	C	x4	D	x4
E	x2	F	x10	G	∅ 3,5 16 x12	H	∅ 4 16 x8
J	x4						

