

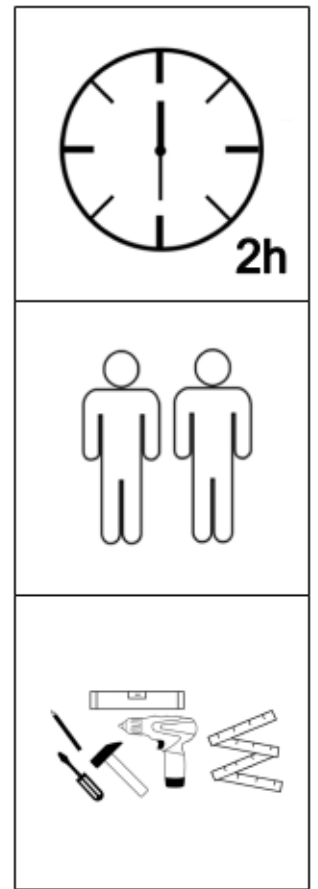

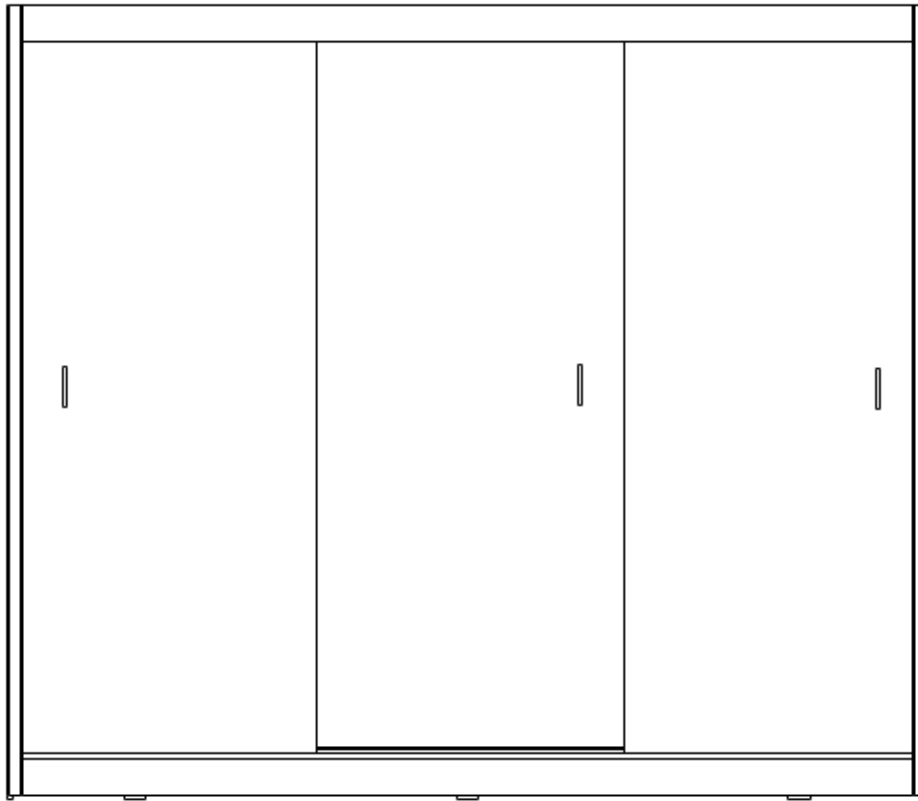









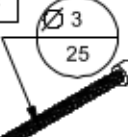
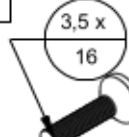
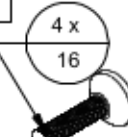
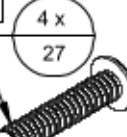

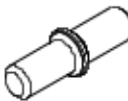



# 250

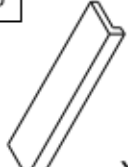

<p>A</p>  <p>x54</p>	<p>B</p>  <p>x8</p>	<p>C</p>  <p>x8</p>	<p>D</p>  <p>x36</p>	<p>E</p>  <p>x12</p>	<p>F</p>  <p>x30</p>	<p>G</p>  <p>x42</p>	<p>H</p>  <p>x6</p>
<p>J</p>  <p>x4</p>	<p>K</p>  <p>x24</p>	<p>L</p>  <p>x1</p>	<p>M</p>  <p>x2</p>	<p>N</p>  <p>x2</p>	<p>P</p>  <p>x2</p>	<p>R</p>  <p>x12</p>	<p>S</p>  <p>x6</p>
<p>T</p>  <p>x6</p>	<p>U</p>  <p>x3</p>	<p>V</p>  <p>x10</p>	<p>W</p>  <p>x230</p>	<p>X</p>  <p>x10</p>	<p>Y</p>  <p>x2</p>		

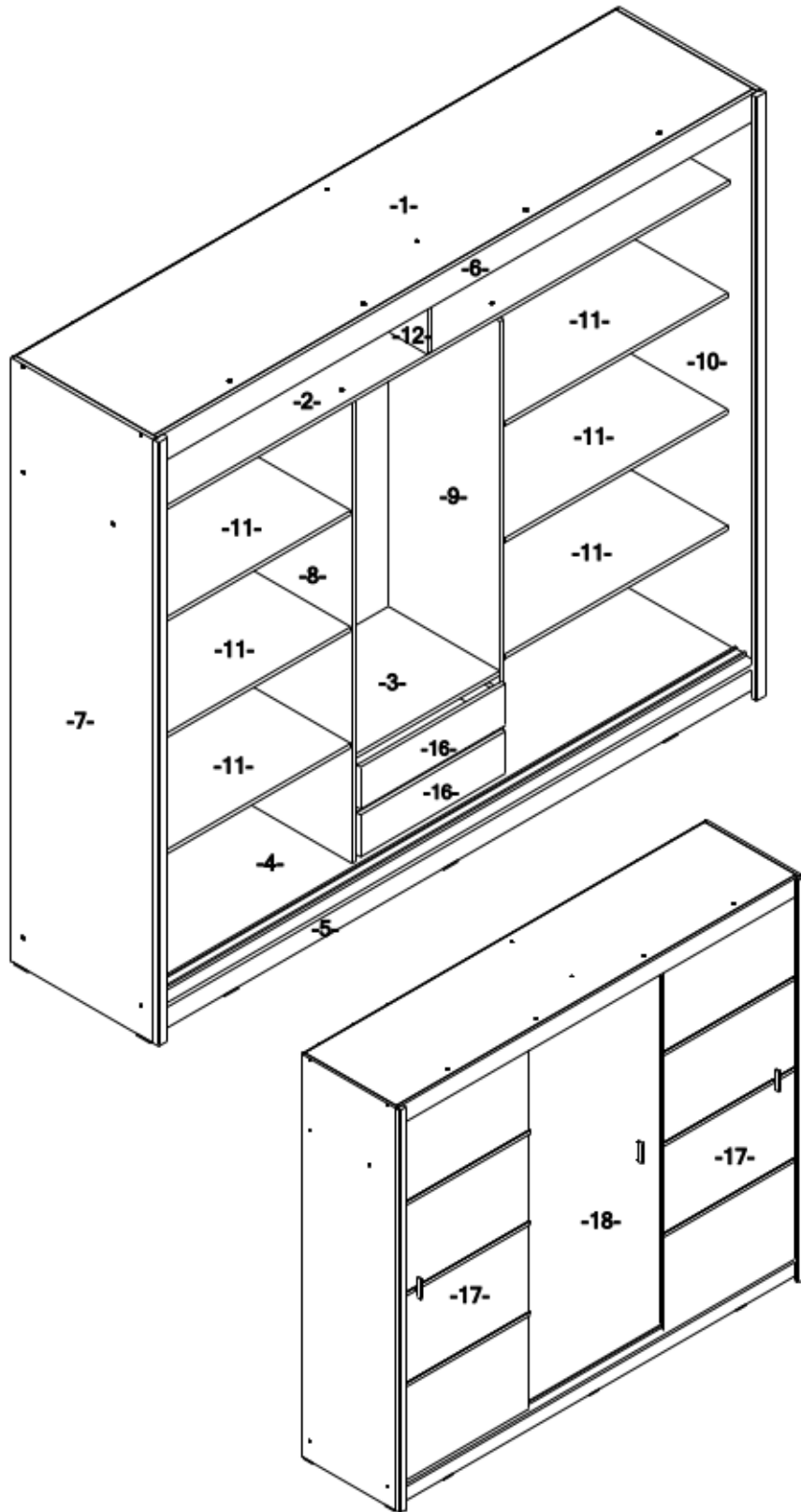
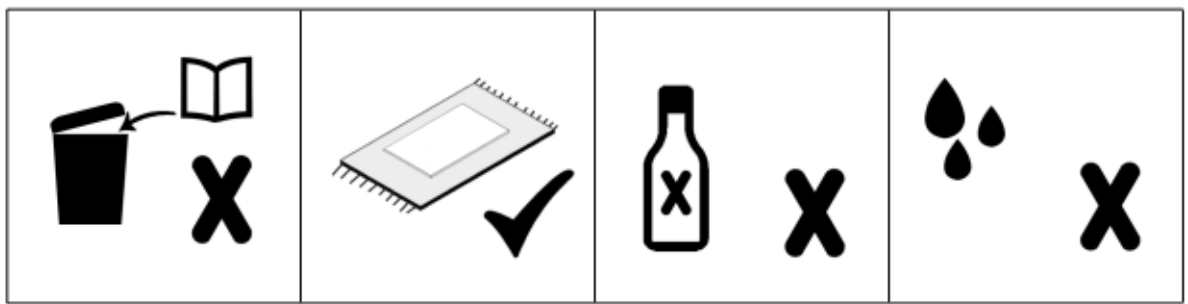

-1-	2468x565	2/4
-2-	2468x466	2/4
-3-	600x466	2/4
-4-	2468x581	2/4
-5-	2x 2468x100	2/4
-6-	2468x70	2/4
-7-	2150x585	1/4
-8-	1642x466	2/4
-9-	1642x466	2/4
-10-	2150x585	1/4
-11-	6x 918x460	1/4
-12-	466x360	2/4
-13-	2x 400x100	2/4
-14-	2x 400x100	2/4
-15-	2x 544x100	1/4
-16-	2x 596x150	1/4
-17-	2x 1990x825	3/4; 4/4
-18-	1990x900	4/4
-19-	3x2050x826	3/4
-20-	2x 573x406	1/4

