

Szafa 200		Szafa 250	
nr		nr	
1	2150 x 581	1	2150 x 581
2	2150 x 581	2	2150 x 581
3	2017 x 475	3	2017 x 475
4	2017 x 475	4	2017 x 475
5	1968 x 565	5	2468 x 565
6	1968 x 581	6	2468 x 581
7	984 x 475	7	1236 x 475
8	476 x 475	8	600 x 475
9	476 x 475	9	600 x 475
10	1968 x 100	10	2468 x 100
11	1968 x 63	11	2468 x 63
12	2004 x 670	12	2004 x 840
13	2040 x 670	13	2004 x 840
14	2040 x 500	14	2040 x 624

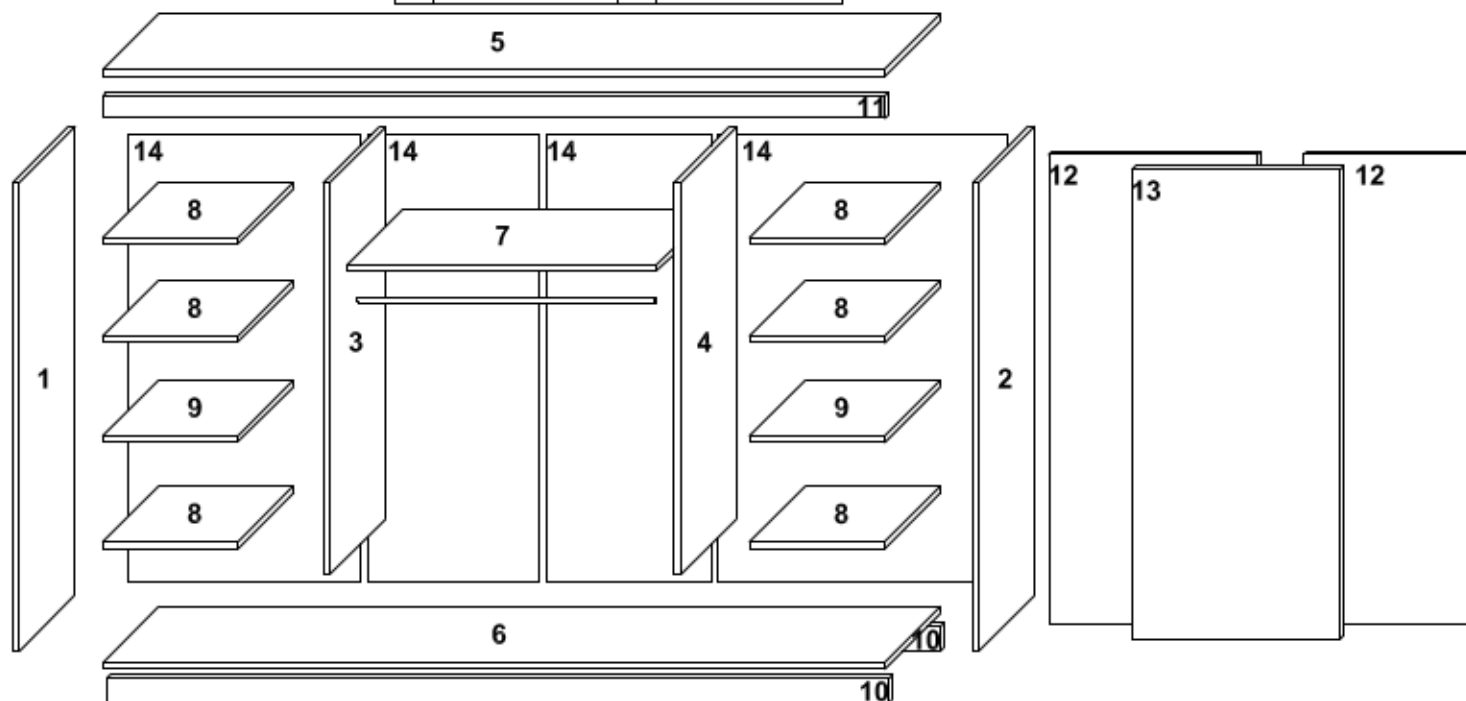

33 A	33 B	33 C	38 D	24 E	14 F	3 kpl N	
2 G	4 H	1 I	2 J	4 K	1 L	1 M	1 N

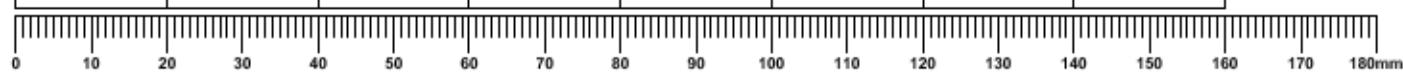

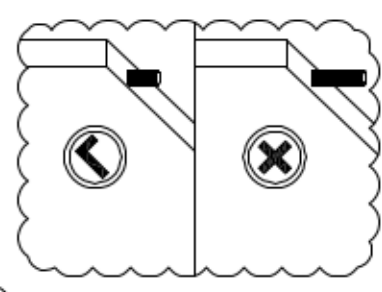
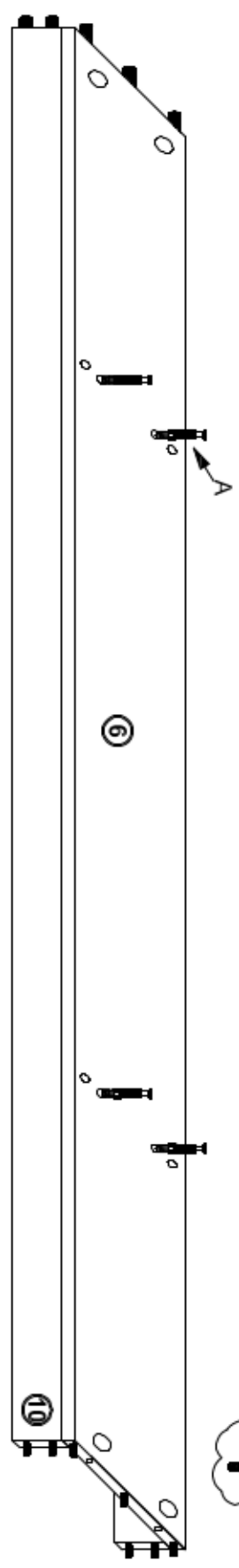
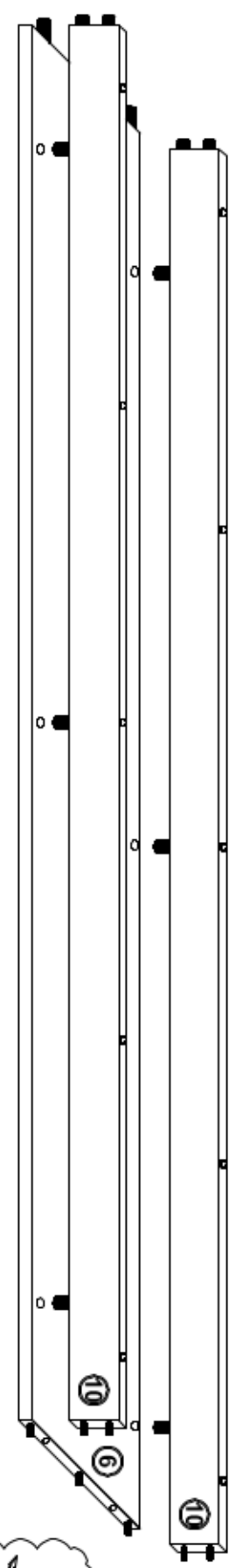
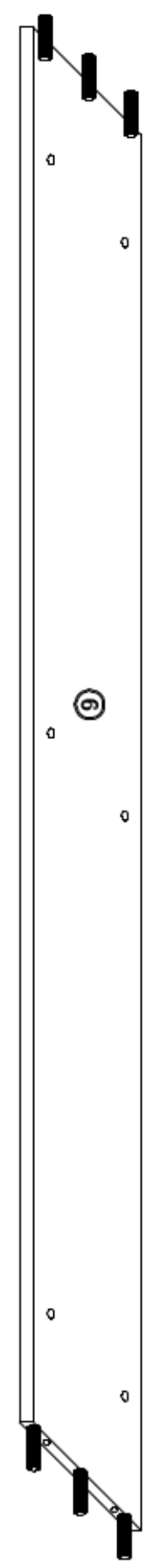
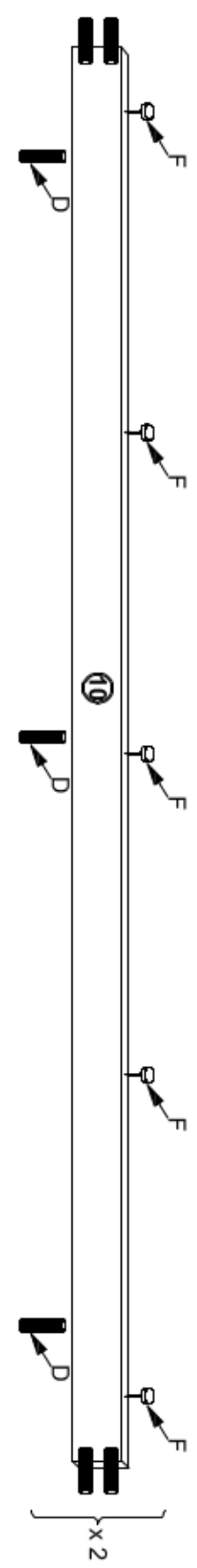

4 A	20 D	10 F

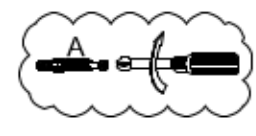

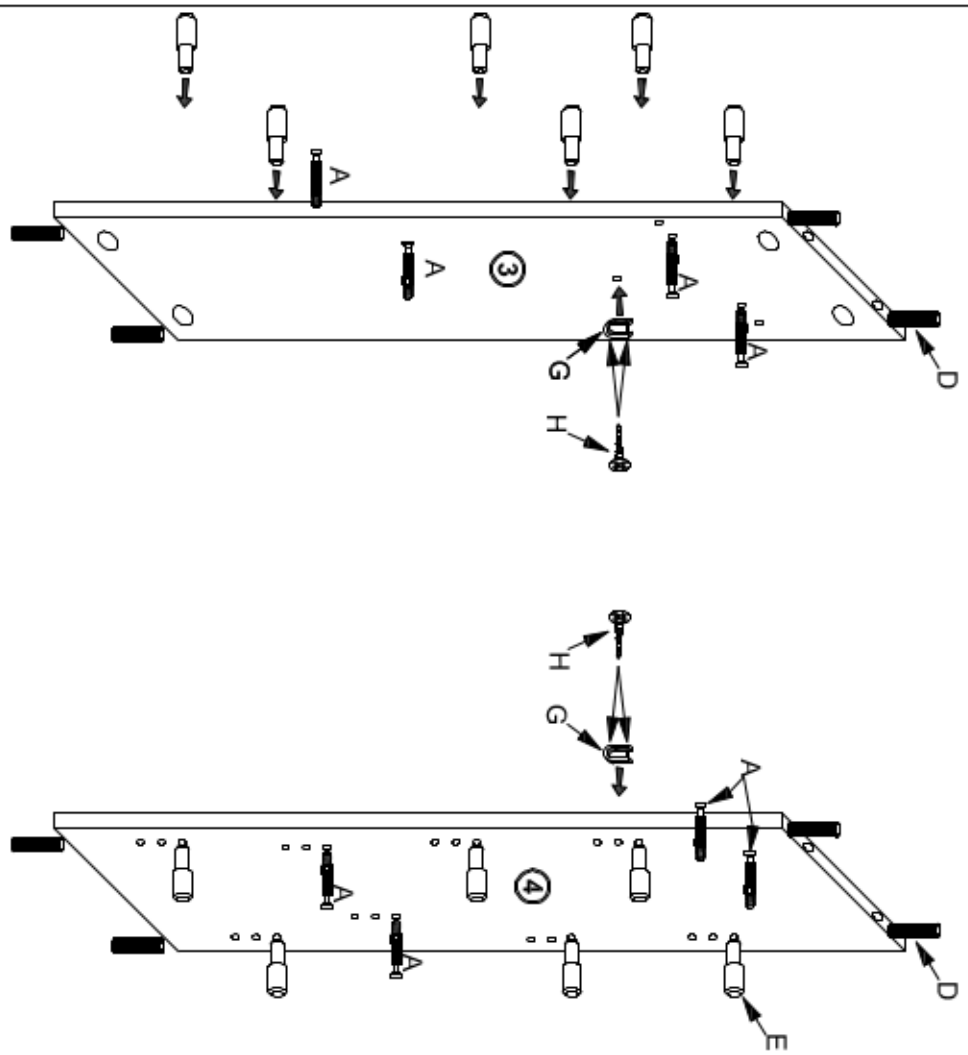

8 A	12 D	2 G	W3,5x7 H	4 H	12 E
-------	--------	-------	------------	-------	--------

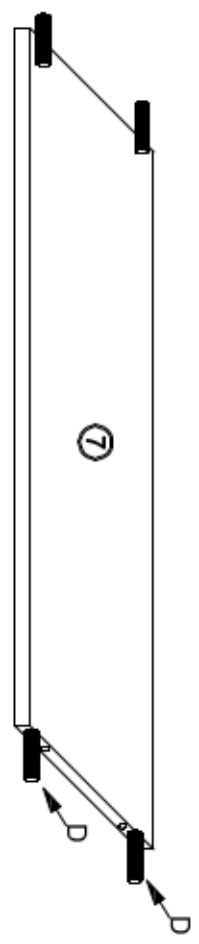
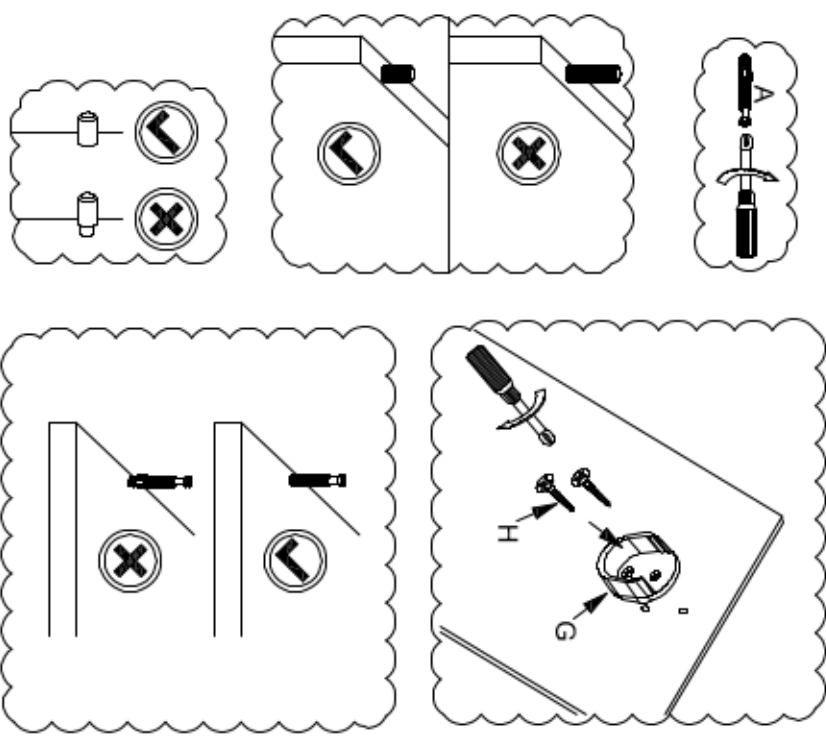

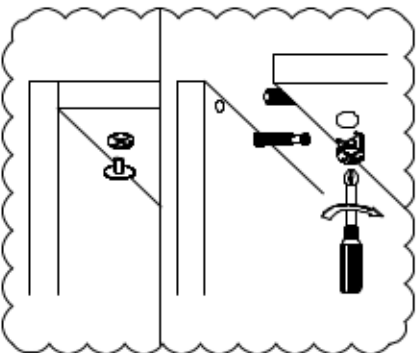
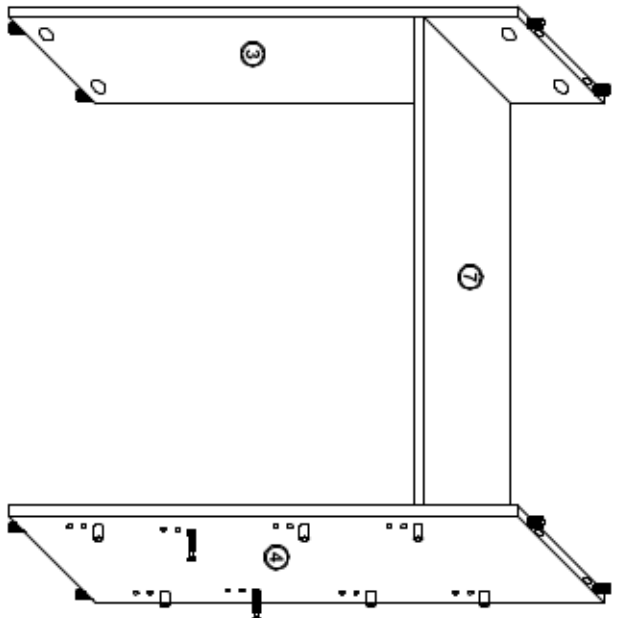
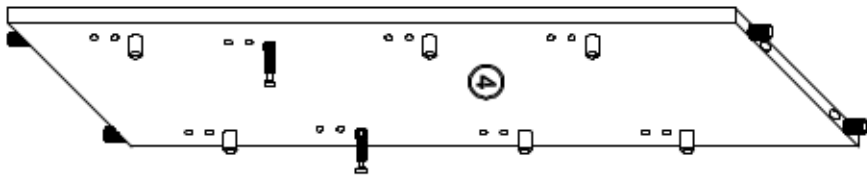
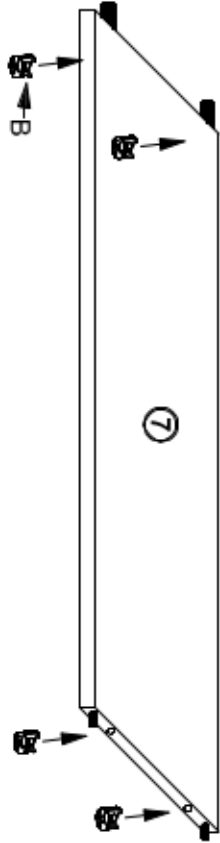
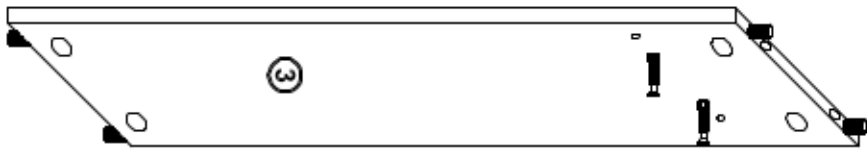

4/B	
4/C	

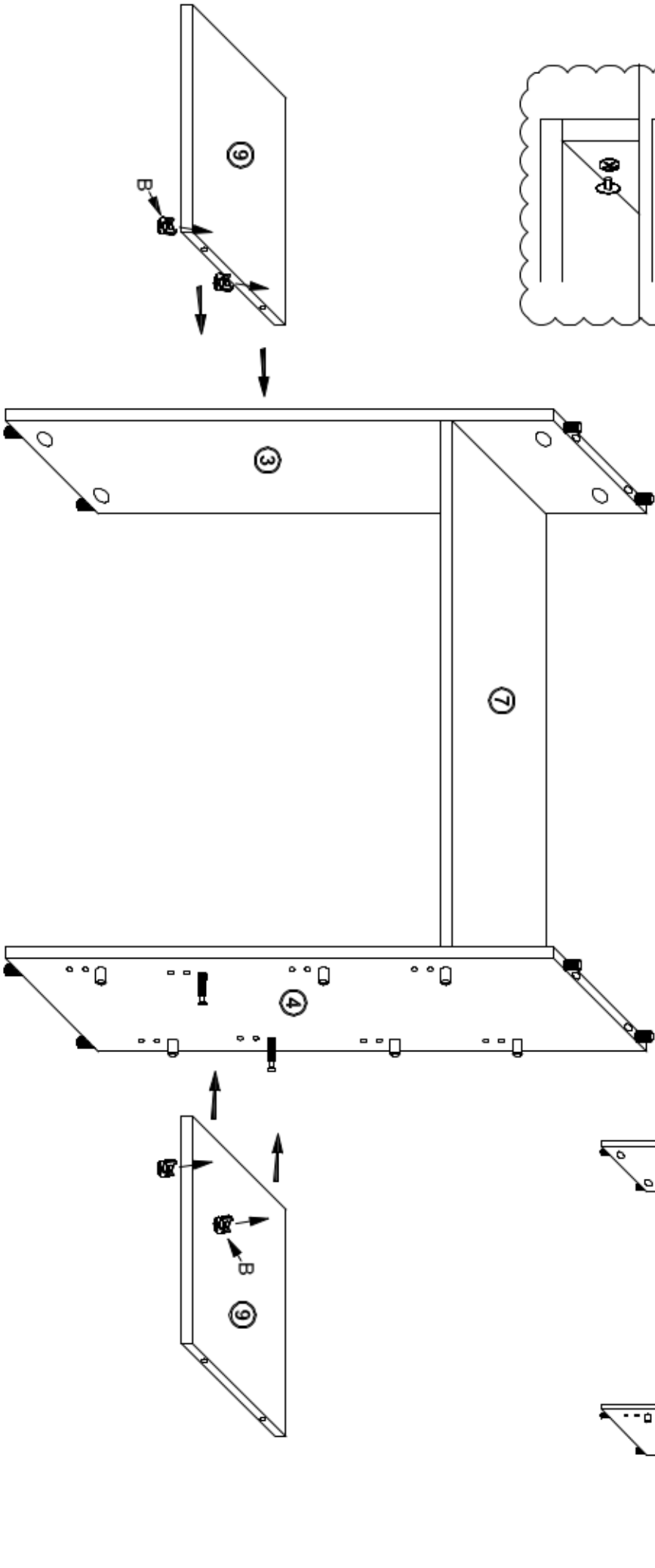
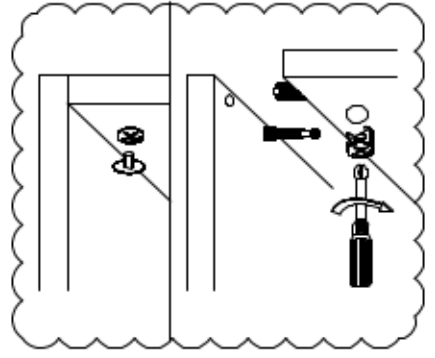

41B	
41C	

4/A	
4/B	
4/C	
6/D	

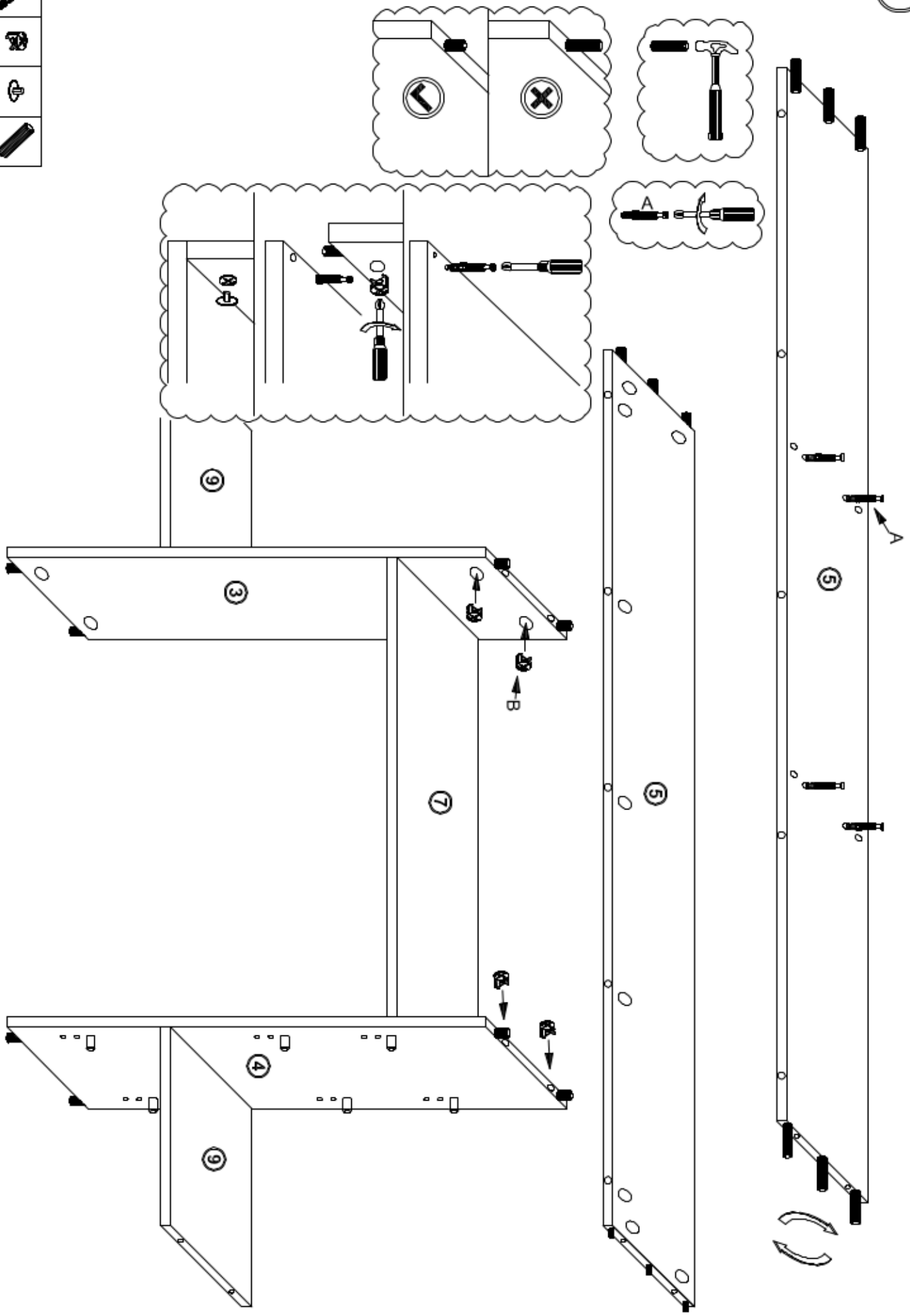

6

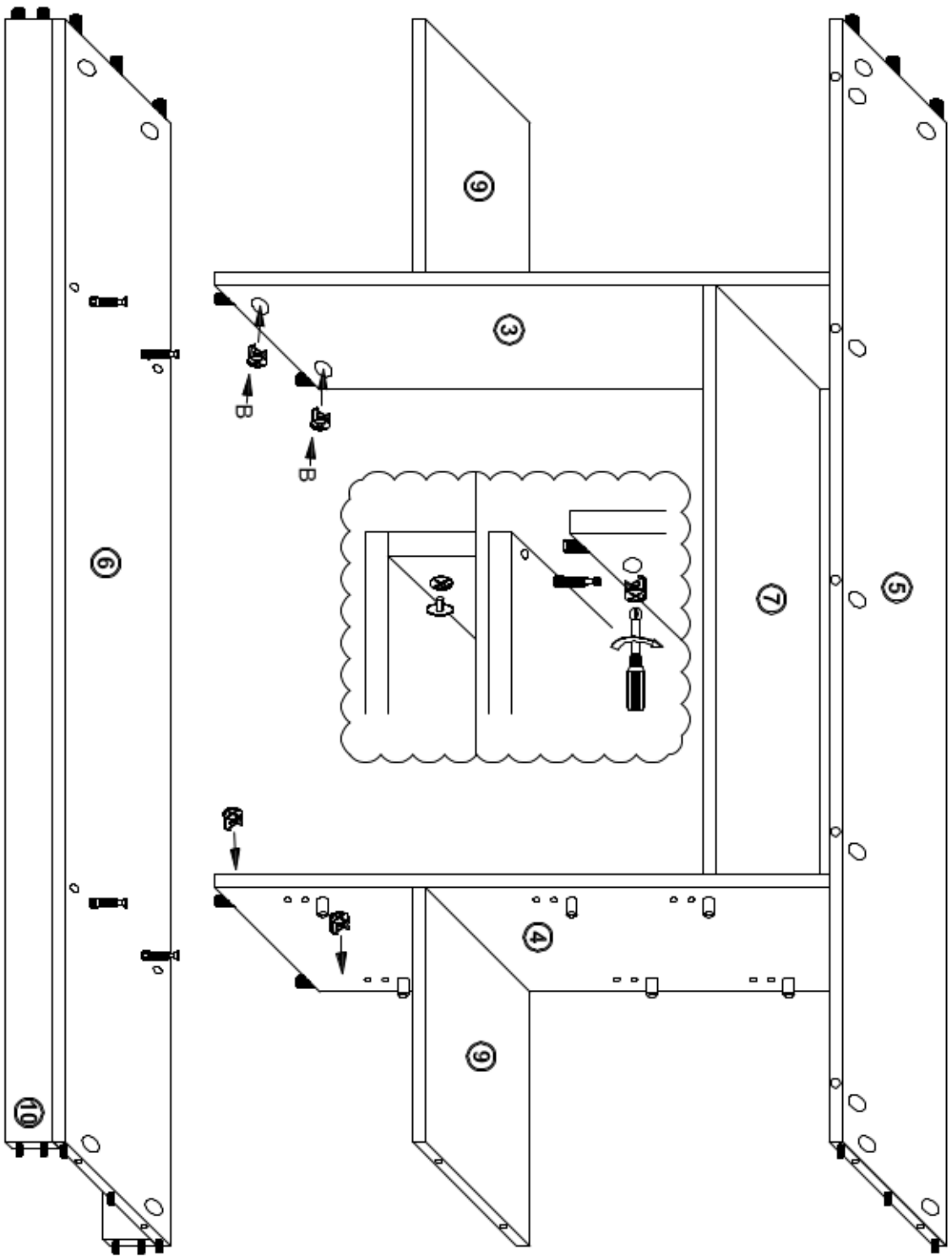

4/B	
4/C	

7

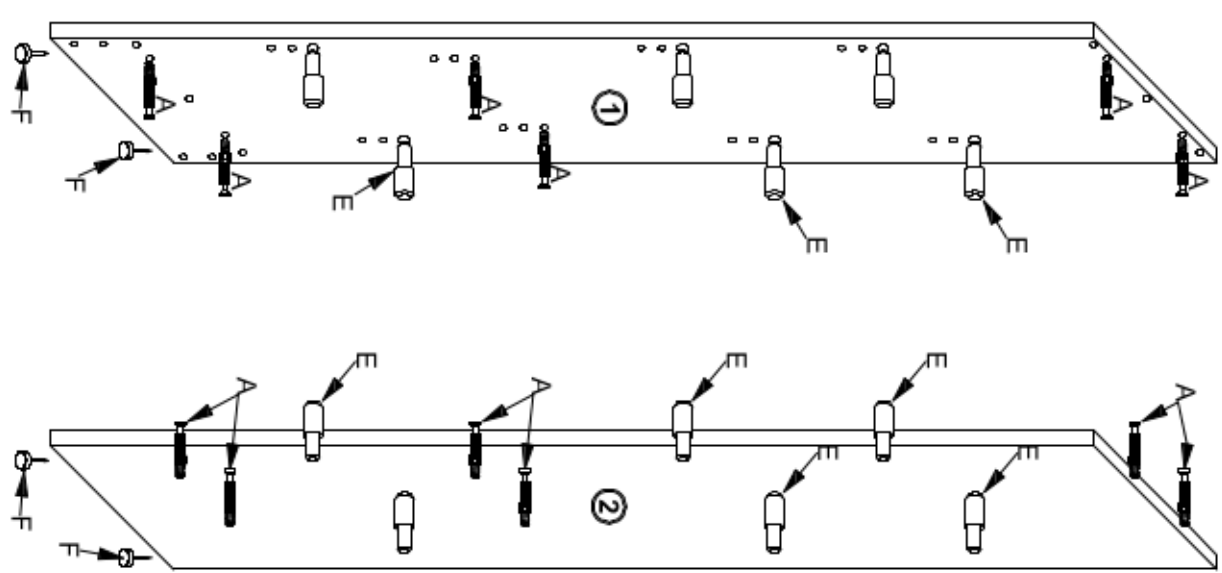

12/A	
12/E	
4/F	



12 B	
12 C	

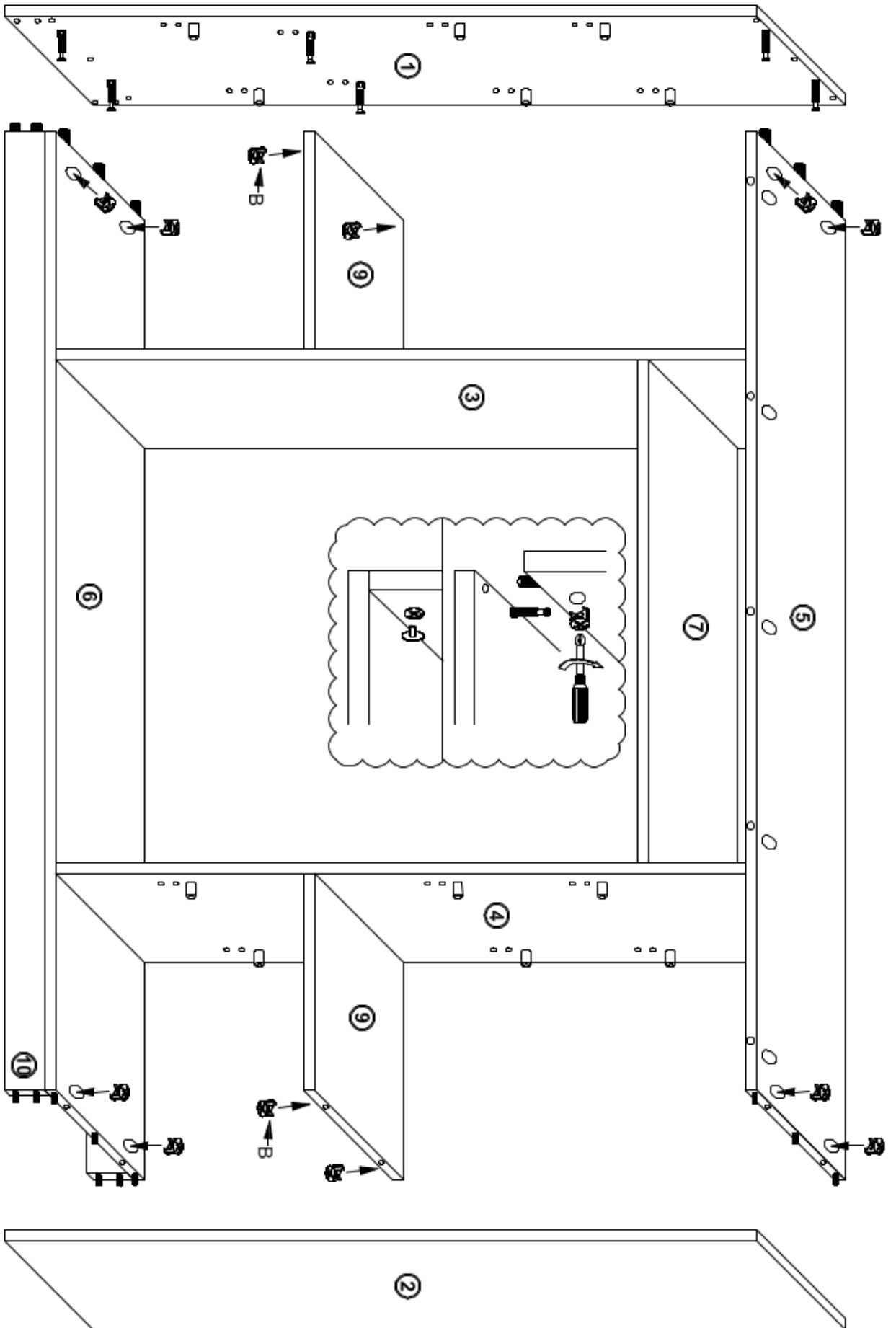

9



A = B

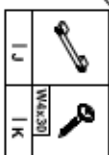
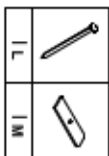
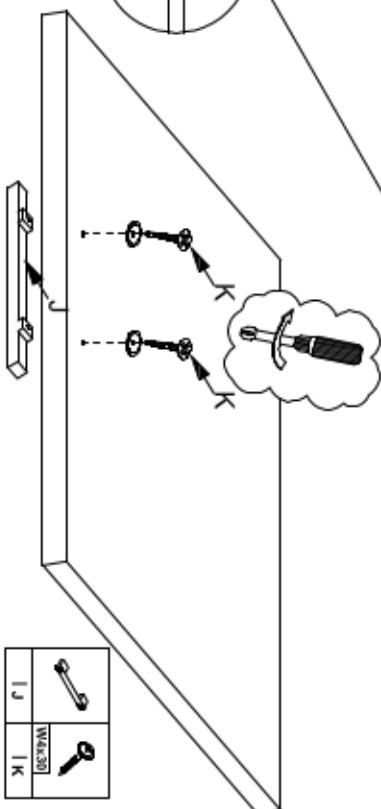
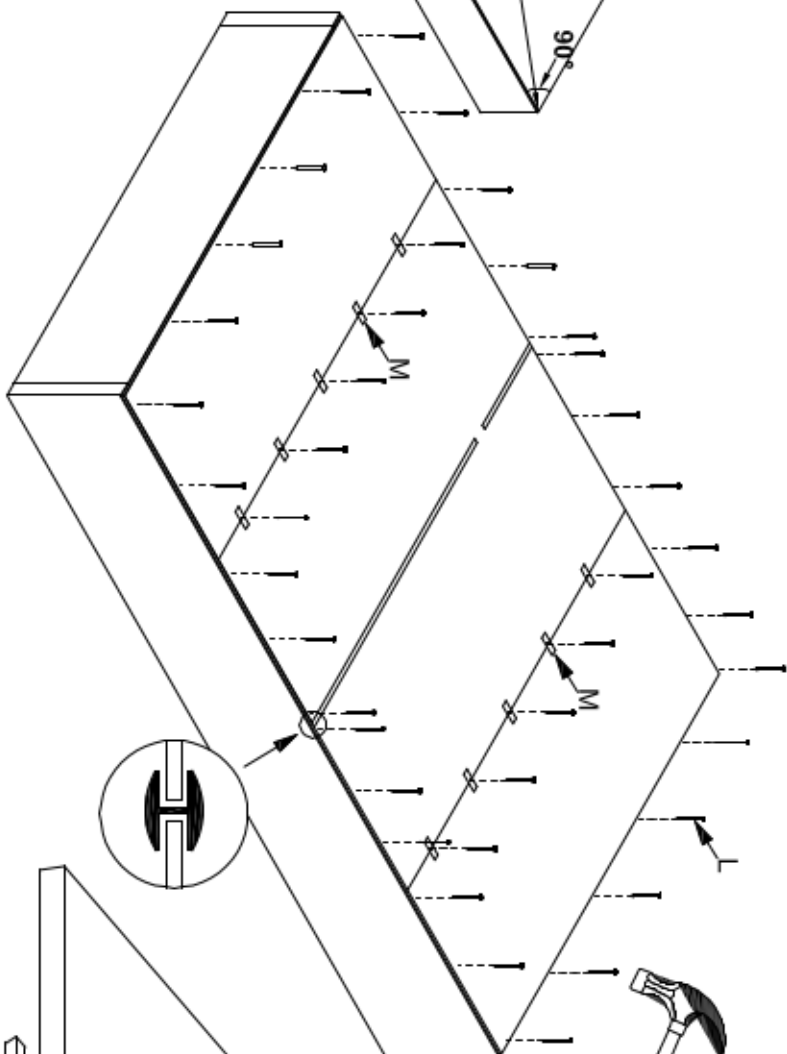
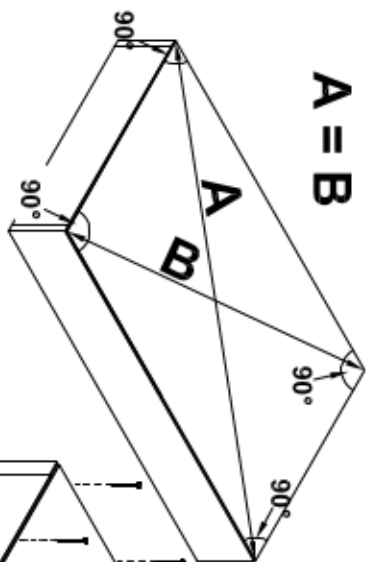

10

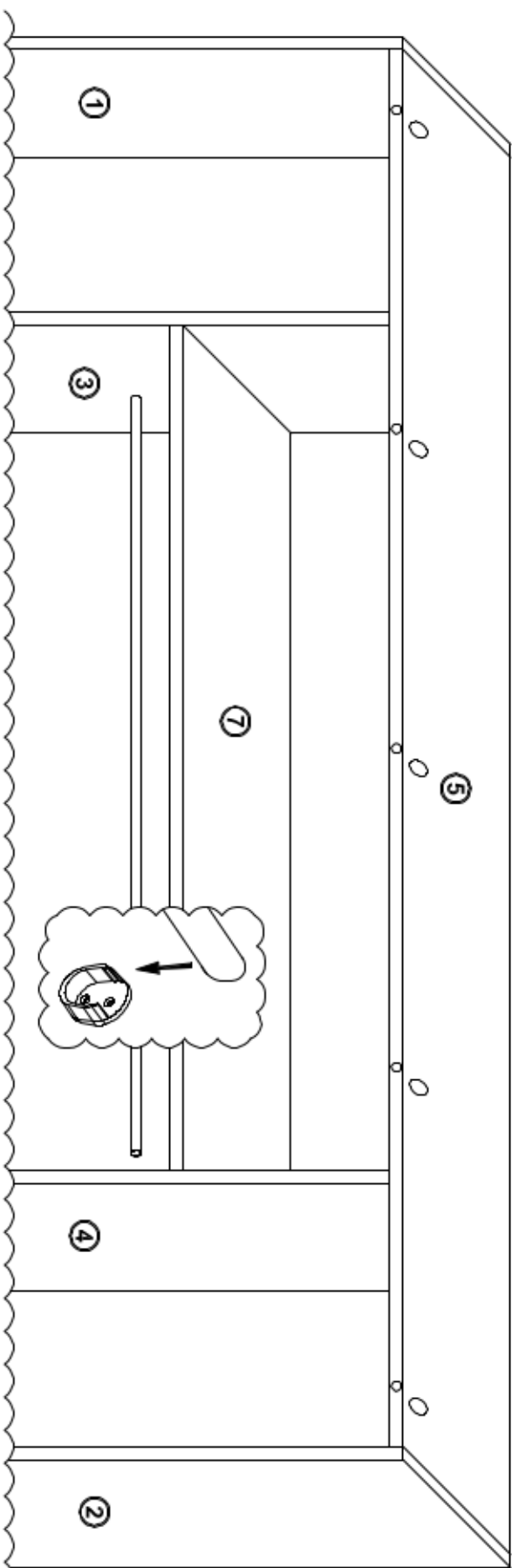

11

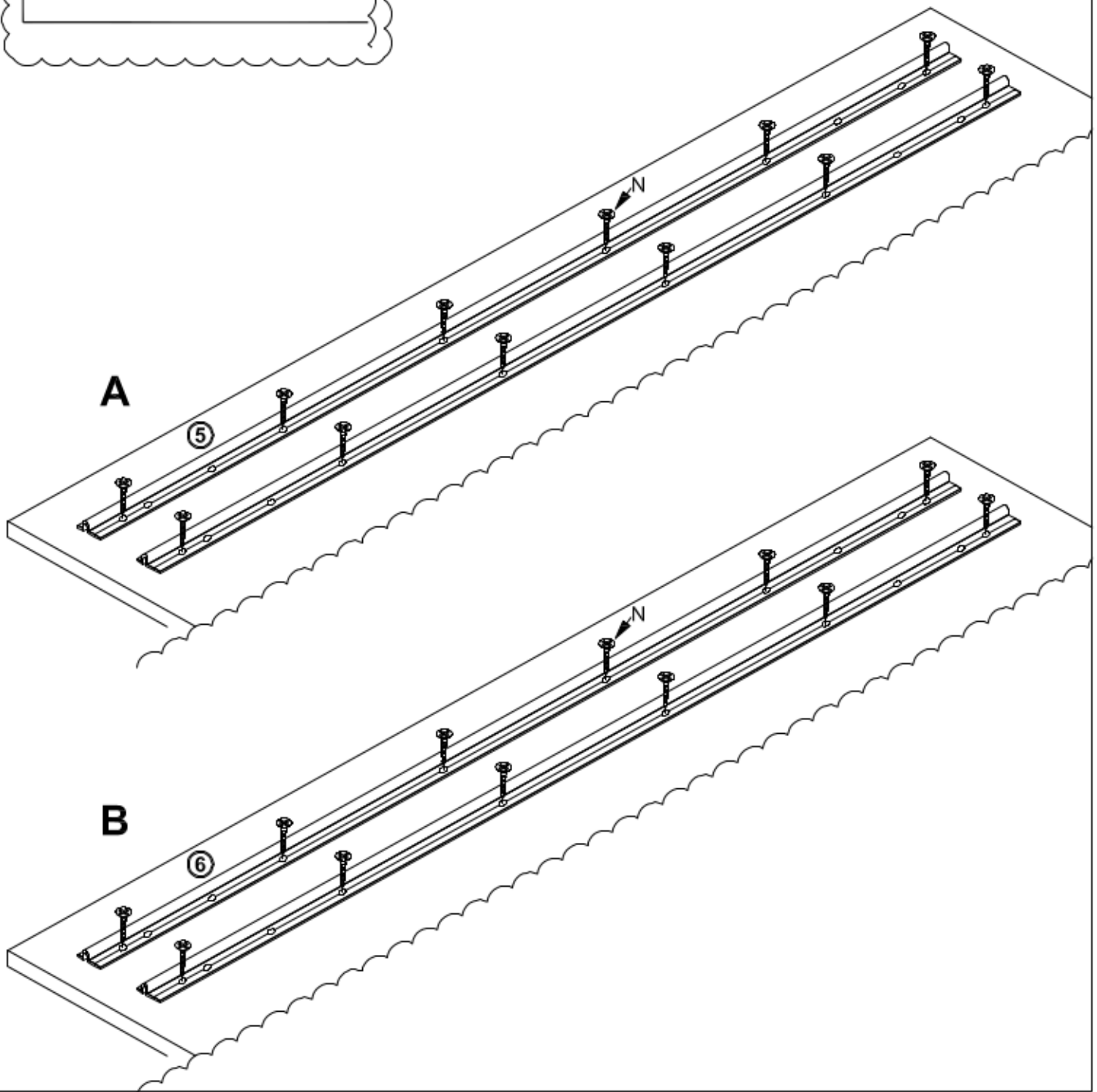
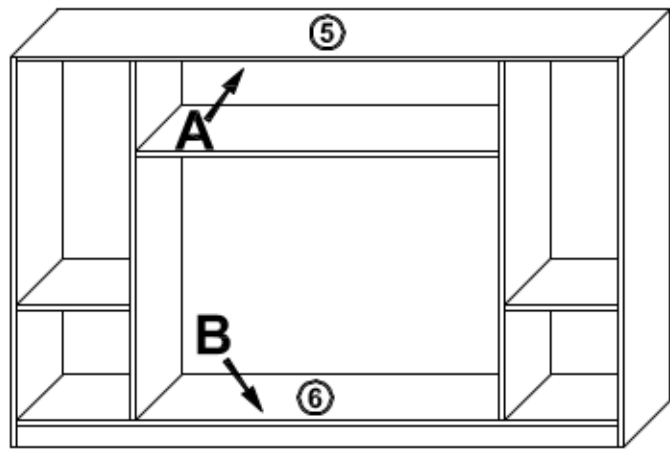
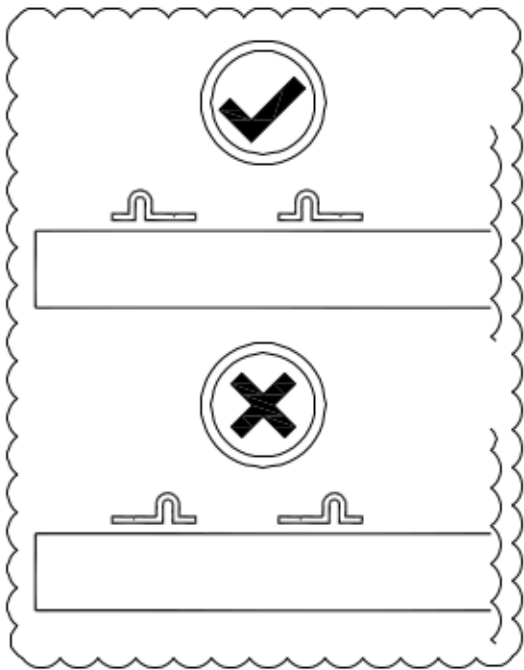

12

1

2

3

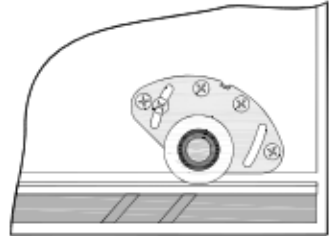
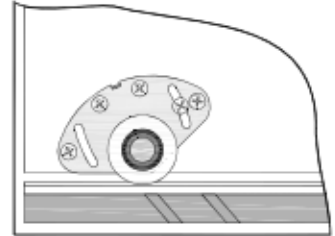
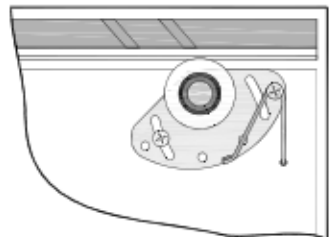
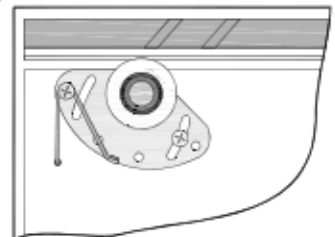
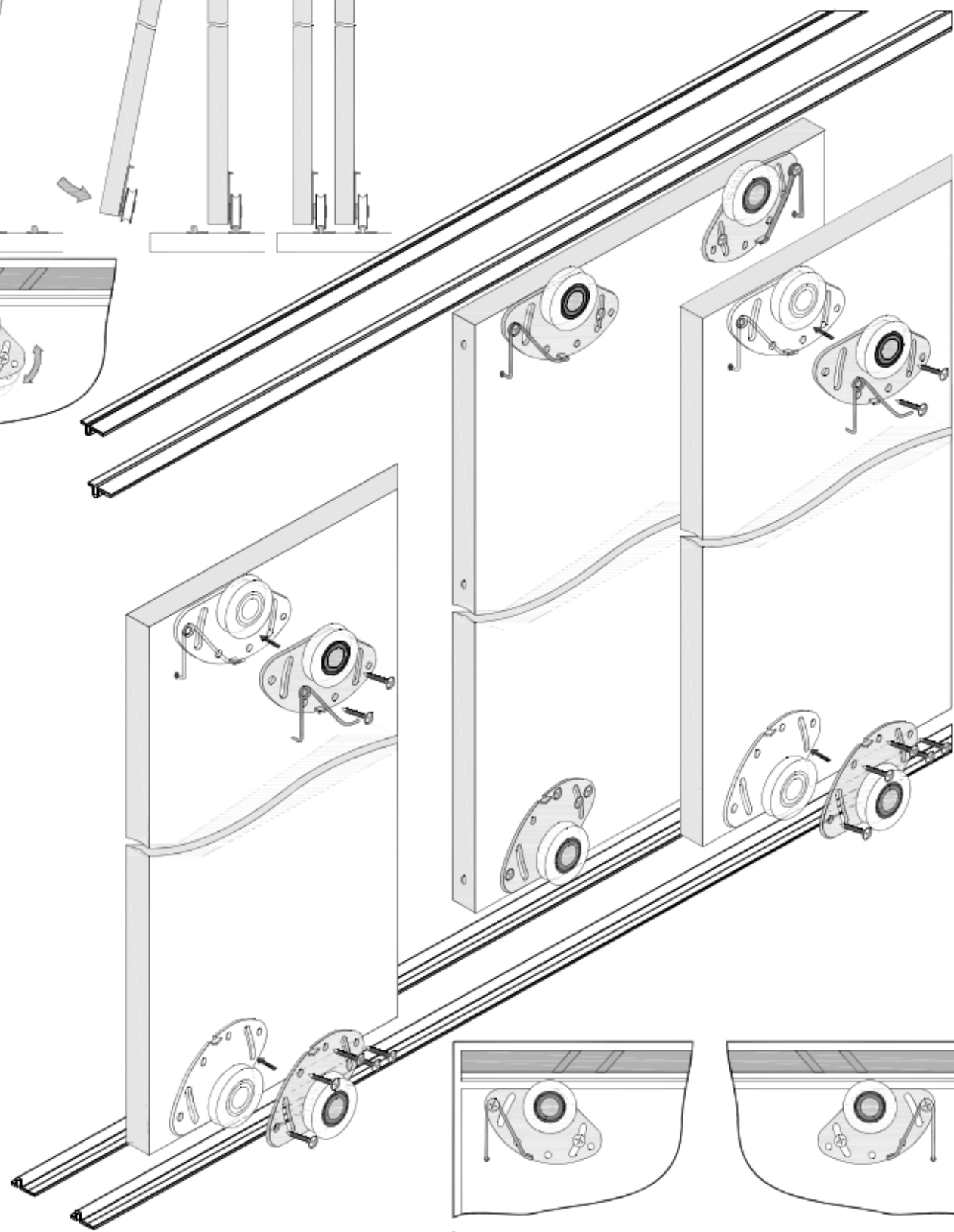
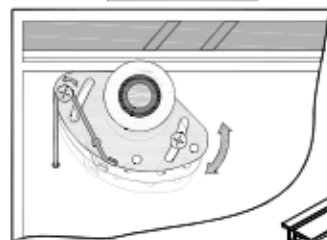
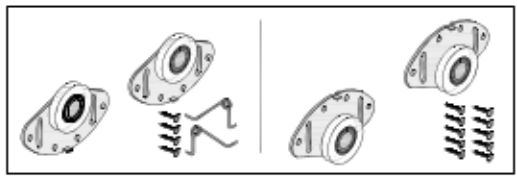

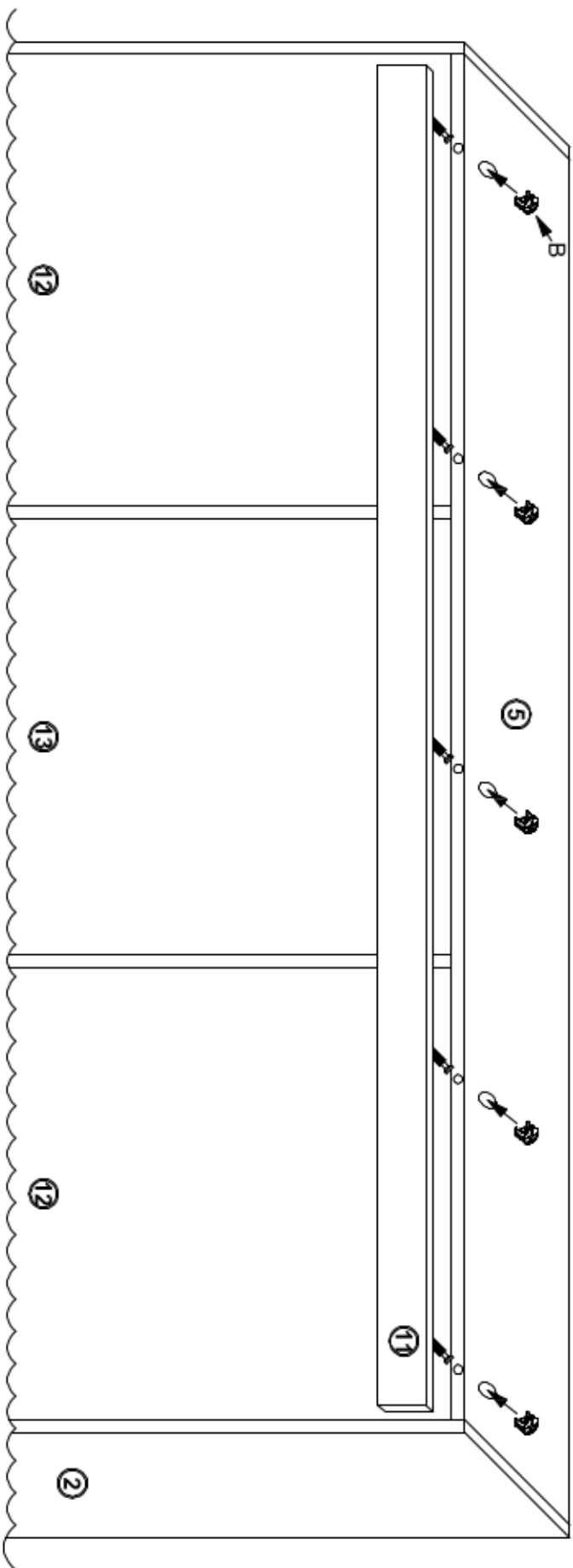
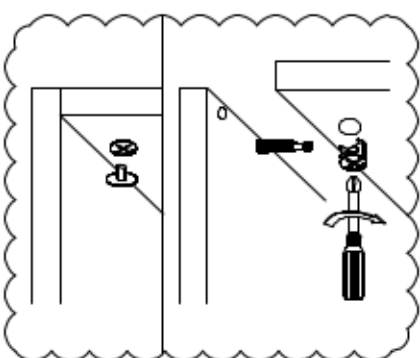
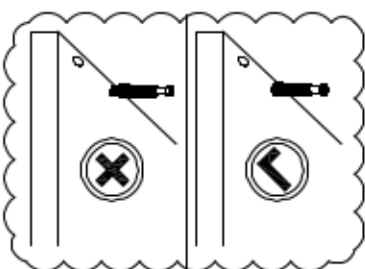
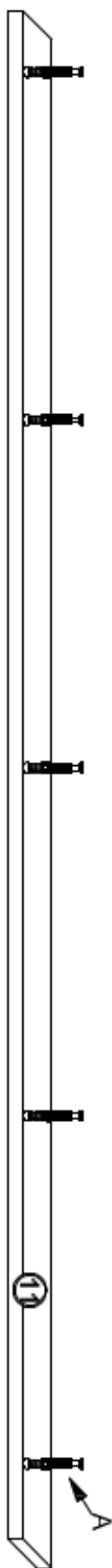

S1A		S1B		S1C	
-----	--	-----	--	-----	--