

20 MIN

2 X



- (D) AUFBAUANLEITUNG
- (NL) HANDLEIDING VOOR DE MONTAGE
- (TR) MONTAJ TALIMATI
- (RO) INSTRUCIUNI DE ASAMBLARE
- (F) INSTRUCTION D'ASSEMBLAGE
- (CZ) POKYNY K MONTÁŽI
- (BG) ИНСТРУКЦИИ ЗА МОНТАЖ
- (HR) UPUTSTVA ZA MONTAŽU

- (GB) ASSEMBLY INSTRUCTIONS
- (PL) INSTRUKCJA MONTAŻU
- (RU) Инструкция по монтажу
- (I) PROCEDURA DI ASSEMBLAGGIO
- (SK) POKYNY K MONTÁŽI
- (HU) ÖSSZESZERELÉSI ÚTMUTATÓ
- (SLO) NAVODILA ZA MONTAŽO
- (S) MONTERINGSANVISNING
- (LT) DIEGIMO INSTRUKCIJOS
- (E) INSTRUCCIONES DE MONTAJE

MODEL "GEMINI"

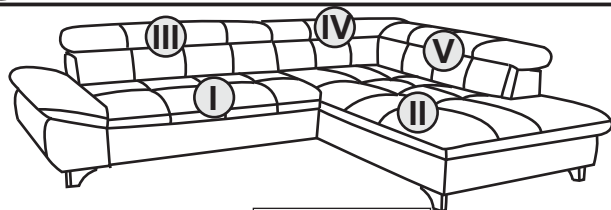

3-OTM

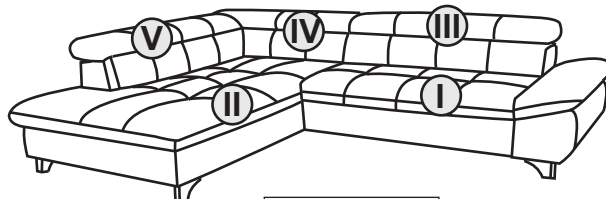

OTM-3

1/3

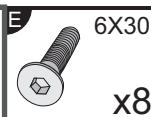
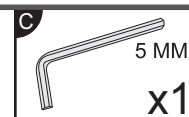

hardware bag/sachet materiel/zubehörbeutel/sachetti materiale/bolsa de materiales/worek materiałowy

pre-assembled/ pre assemble/ vormontiert/ premontato/ wstępnie/ zamontowane

**1**

**2**

**3**

**PENSEZ AU TRI!**

ENSEMBLE REDUONS L'IMPACT ENVIRONNEMENTAL DES EMBALLAGES

ÉLÉMENTS BOIS PLASTIQUE A JETER

ÉLÉMENTS METAL CARTON PAPIER A RECYCLER

20 MIN

2 X



- (D) AUFBAUANLEITUNG
- (NL) HANDLEIDING VOOR DE MONTAGE
- (TR) MONTAJ TALIMATI
- (RO) INSTRUCIUNI DE ASAMBLARE
- (F) INSTRUCTION D'ASSEMBLAGE
- (CZ) POKYNY K MONTÁŽI
- (BG) ИНСТРУКЦИИ ЗА МОНТАЖ
- (HR) UPUTSTVA ZA MONTAŽU

- (GB) ASSEMBLY INSTRUCTIONS
- (PL) INSTRUKCJA MONTAŻU
- (RU) Инструкция по монтажу
- (I) PROCEDURA DI ASSEMBLAGGIO
- (SK) POKYNY K MONTÁŽI
- (HU) ÖSSZESZERELÉSI ÚTMUTATÓ
- (SLO) NAVODILA ZA MONTAŽO
- (S) MONTERINGSANVISNING
- (LT) DIEGIMO INSTRUKCIJOS
- (E) INSTRUCCIONES DE MONTAJE

MODEL "GEMINI"

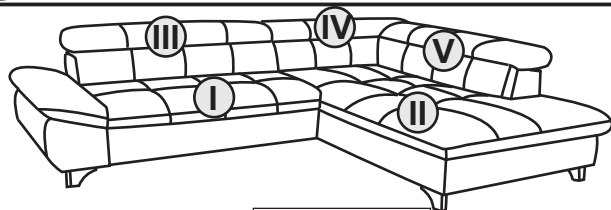

3-OTM

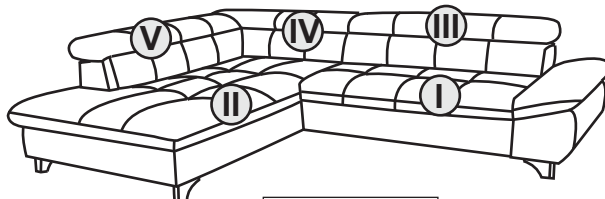

OTM-3

2/3

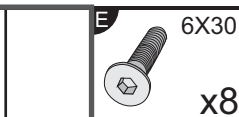
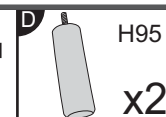
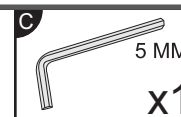

hardware bag/sachet matériel/zubehörbeutel/sachetti materiale/bolsa de materiales/worek materiałowy pre-assembled/ pre assemble/ vormontiert/ premontato/ wstępnie zamontowane

4

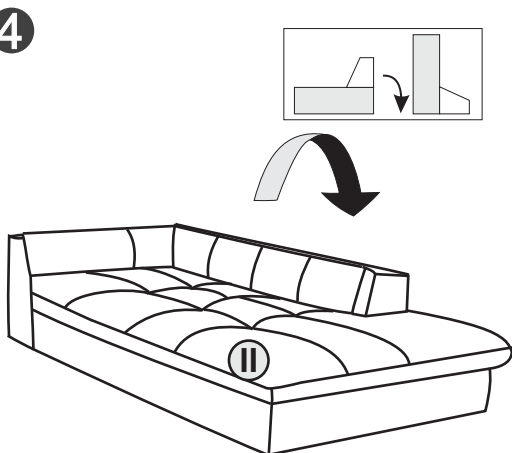

5

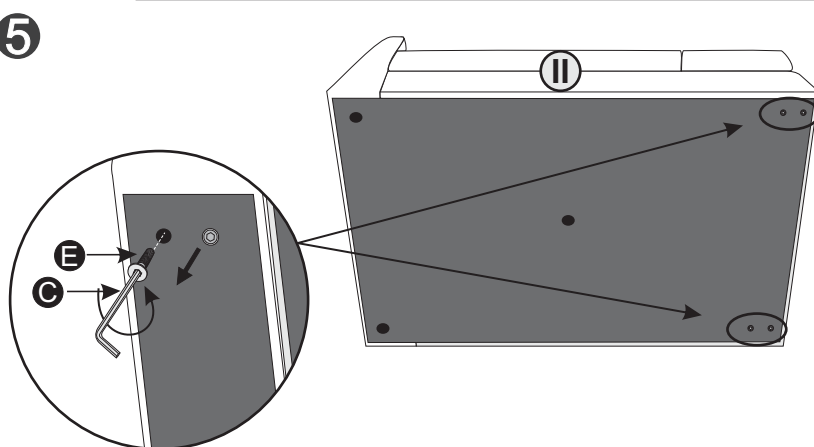

6

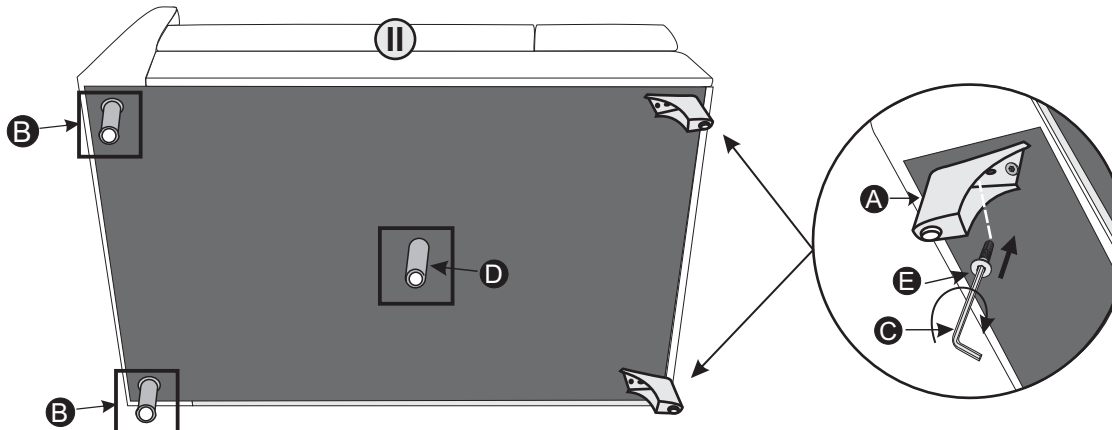
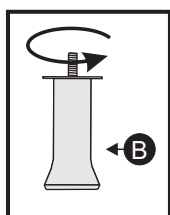
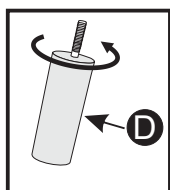

7

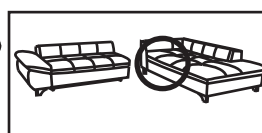
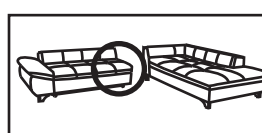
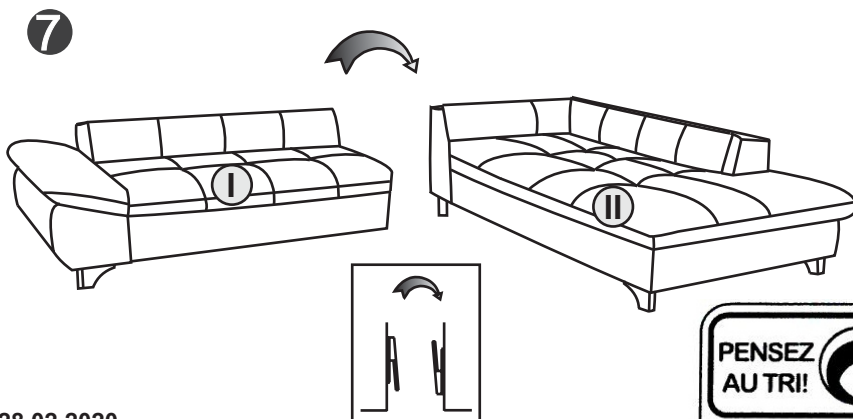

**PENSEZ AU TRI!**

ENSEMBLE REDUONS L'IMPACT ENVIRONNEMENTAL DES EMBALLAGES

ÉLÉMENTS BOIS PLASTIQUE A JETER

ÉLÉMENTS METAL CARTON PAPIER A RECYCLER

101-28.02.2020

CONSIGNE POUVANT VARIER LOCALEMENT > WWW.CONSIGNESDETR.FR

20 MIN

2 X



- (D) AUFBAUANLEITUNG
- (NL) HANDLEIDING VOOR DE MONTAGE
- (TR) MONTAJ TALIMATI
- (RO) INSTRUCTIUNI DE ASAMBLARE
- (F) INSTRUCTION D'ASSEMBLAGE
- (CZ) POKYNY K MONTÁŽI
- (BG) ИНСТРУКЦИИ ЗА МОНТАЖ
- (HR) UPUTSTVA ZA MONTAŽU

- (GB) ASSEMBLY INSTRUCTIONS
- (PL) INSTRUKCJA MONTAŻU
- (RU) Инструкция по монтажу
- (I) PROCEDURA DI ASSEMBLAGGIO
- (SK) POKYNY K MONTÁŽI
- (HU) ÖSSZESZERELÉSI ÚTMUTATÓ
- (SLO) NAVODILA ZA MONTAŽO
- (S) MONTERINGSANVISNING
- (LT) DIEGIMO INSTRUKCIJOS
- (E) INSTRUCCIONES DE MONTAJE

MODEL "GEMINI"

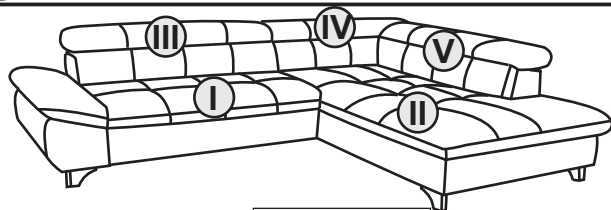

3-OTM

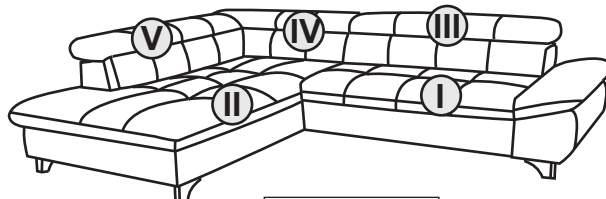

OTM-3

3/3

8

1/3

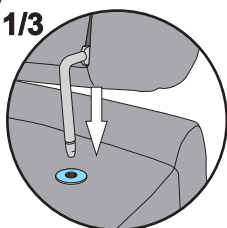

2/3

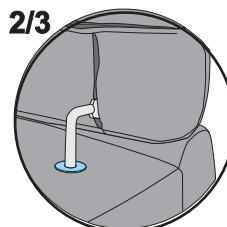

3/3

