

- (D) AUFBAUANLEITUNG
- (NL) HANDLEIDING VOOR DE MONTAGE
- (TR) MONTAJ TALIMATI
- (RO) INSTRUCIUNI DE ASAMBLARE
- (F) INSTRUCTION D'ASSEMBLAGE
- (CZ) POKYNY K MONTÁŽI
- (BG) ИНСТРУКЦИИ ЗА МОНТАЖ
- (HR) NAPUTCI ZA MONTAŽU
- (E) INSTRUCCIONES DE MONTAJE
- (GB) ASSEMBLY INSTRUCTIONS
- (PL) INSTRUKCJA MONTAŻU
- (RU) Инструкция по монтажу
- (I) PROCEDURA DI ASSEMBLAGGIO
- (SK) POKYNY K MONTÁŽI
- (HU) KÖZGYŰLÉS UTASÍTÁSOK
- (SL) ASSEMBLY INSTRUCTIONS
- (S) MONTERINGSANVISNING
- (LT) DIEGIMO INSTRUKCIJOS

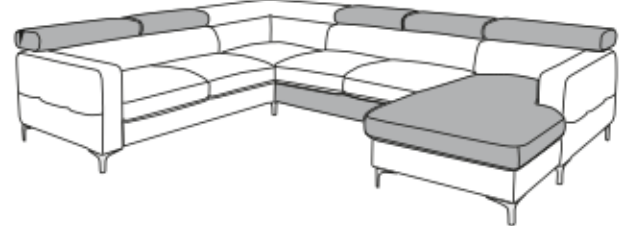

1/2

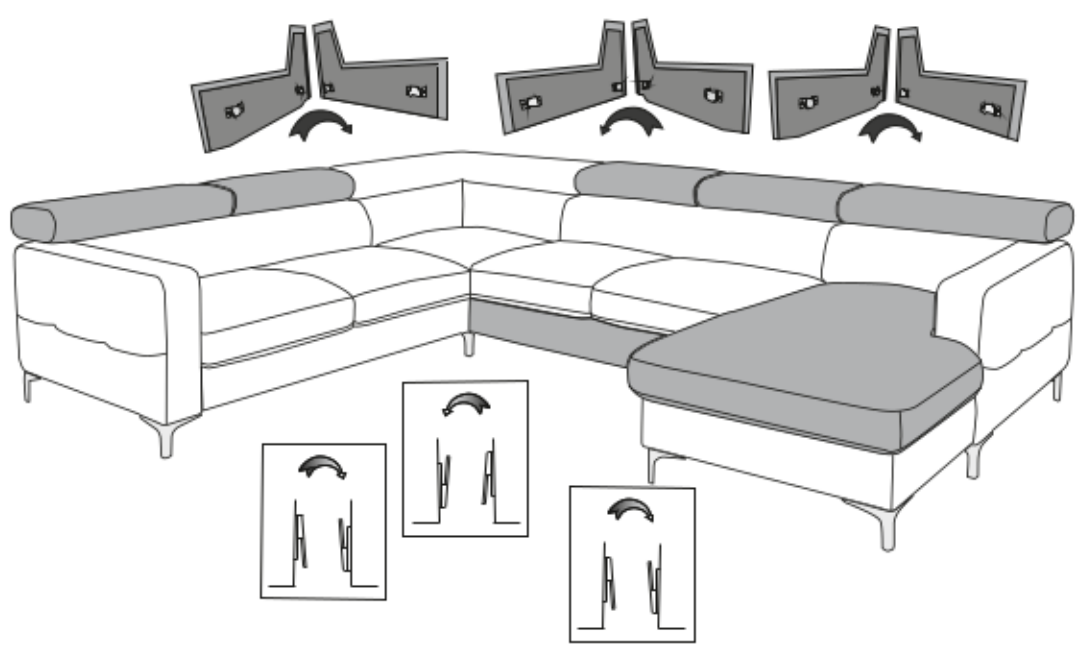
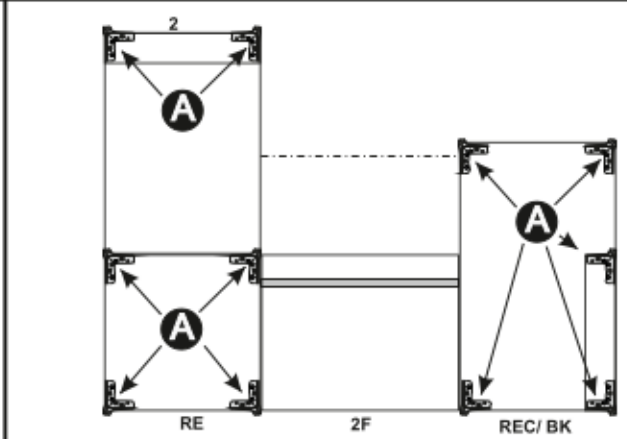
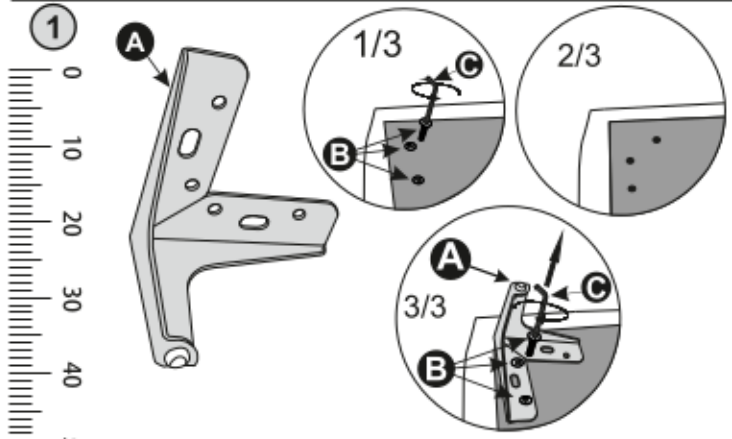
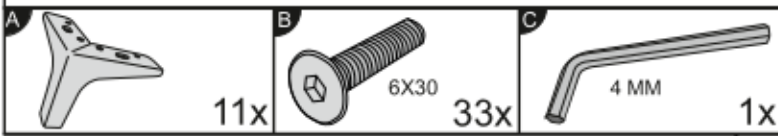

0
10
20
30
40
50
60
70
80
90
100
110
120
130
140
150
160
170
180

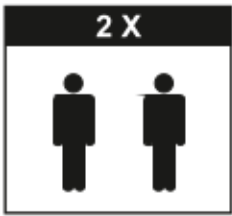

- | | |
|----------------------------------|-------------------------------|
| (D) AUFBAUANLEITUNG | (GB) ASSEMBLY INSTRUCTIONS |
| (NL) HANDLEIDING VOOR DE MONTAGE | (PL) INSTRUKCJA MONTAŻU |
| (TR) MONTAJ TALIMATI | (RU) Инструкция по монтажу |
| (RO) INSTRUCTIUNI DE ASAMBLARE | (I) PROCEDURA DI ASSEMBLAGGIO |
| (F) INSTRUCTION D'ASSEMBLAGE | (SK) POKYNY K MONTÁŽI |
| (CZ) POKYNY K MONTÁŽI | (HU) KÖZGYŰLÉS UTASÍTÁSOK |
| (BG) ИНСТРУКЦИИ ЗА МОНТАЖ | (SL) ASSEMBLY INSTRUCTIONS |
| (HR) NAPUTCI ZA MONTAŽU | (S) MONTERINGSANVISNING |
| (E) INSTRUCCIONES DE MONTAJE | (LT) DIEGIMO INSTRUKCIJOS |



2/2

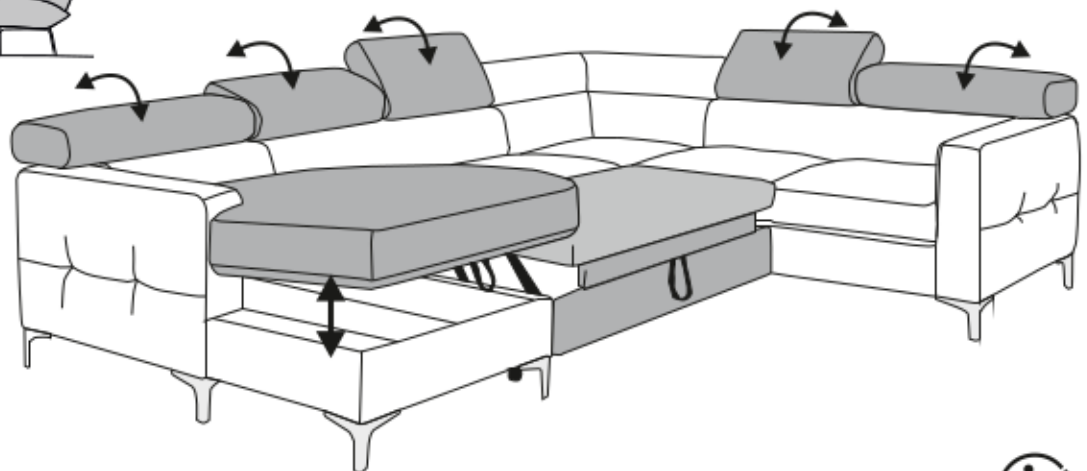
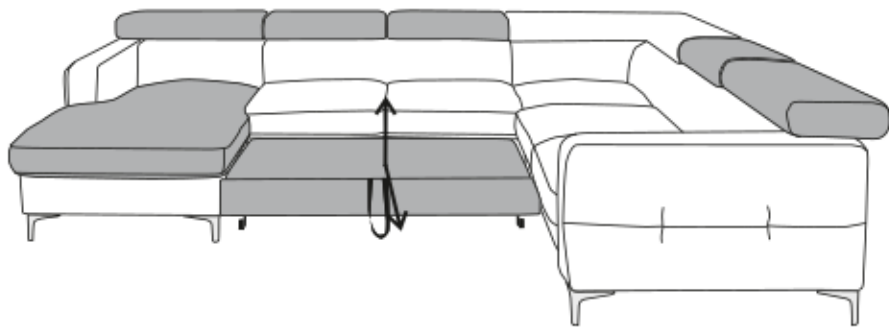
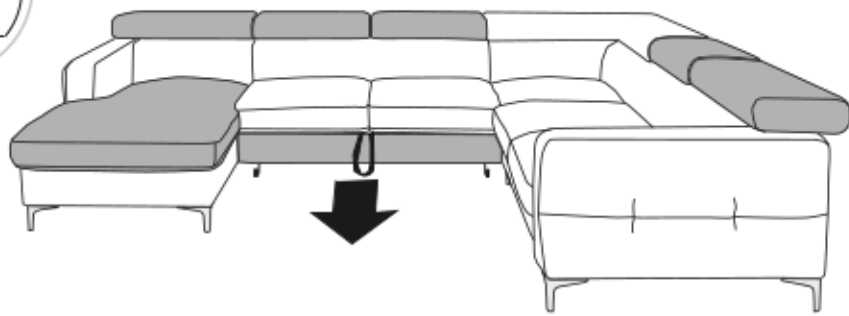
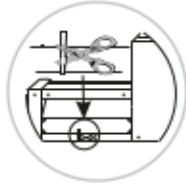

0
10
20
30
40
50
60
70
80
90
100
110
120
130
140
150
160
170
180

