

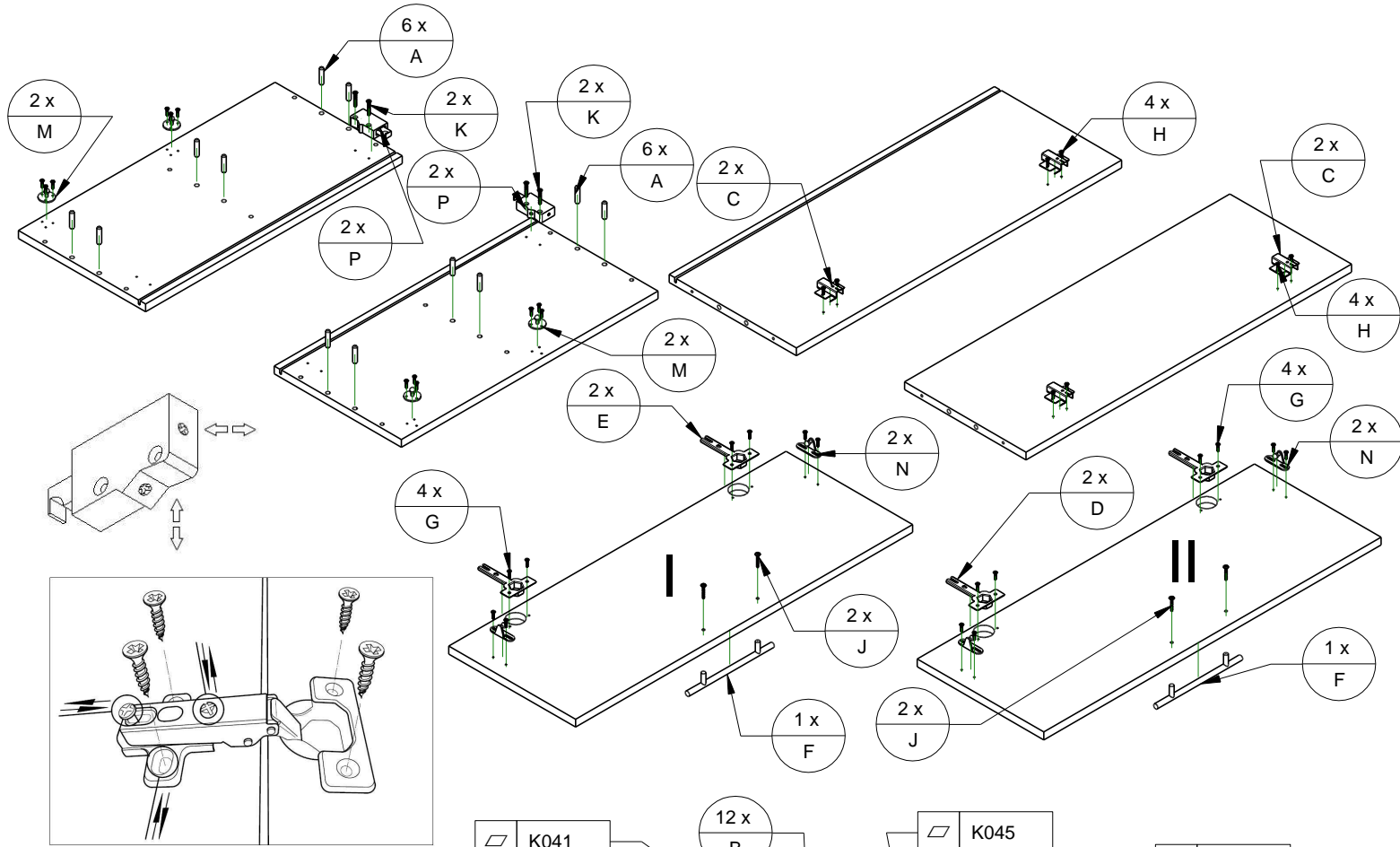









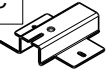



G80uw



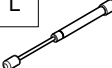

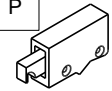

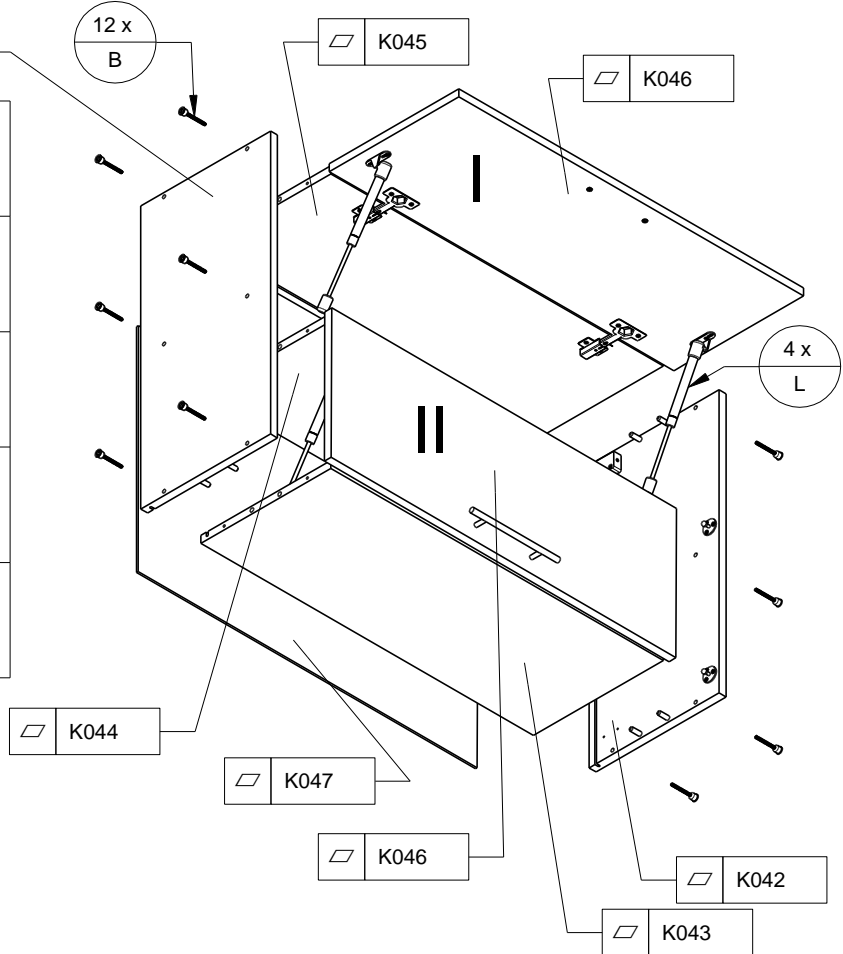
A	B	C
		
x12	x12	x4
D	E	F
		
x2	x2	x2
G	H	J
		
$\varnothing 3,5$ 16 x8	$\varnothing 4$ 16 x8	x4
K	L	M
		
x4	x4	x4
N	P	R
		
x4	x2	

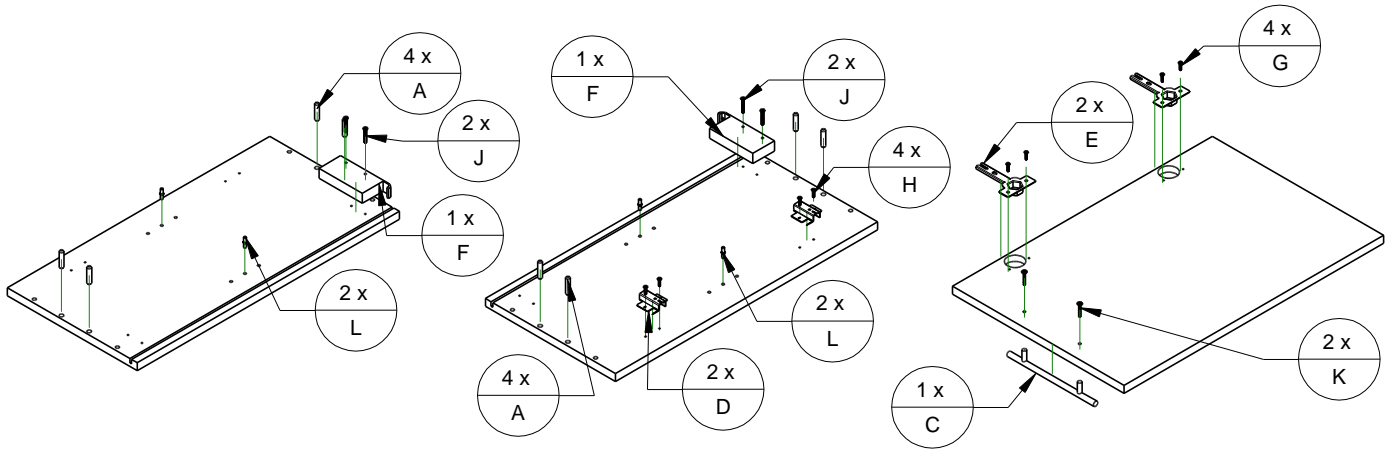

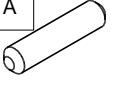
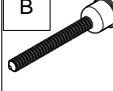
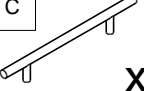
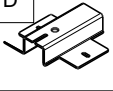
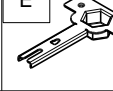
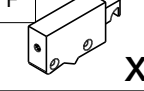
G30/40/60 1F

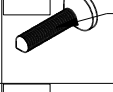
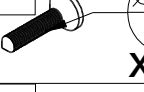



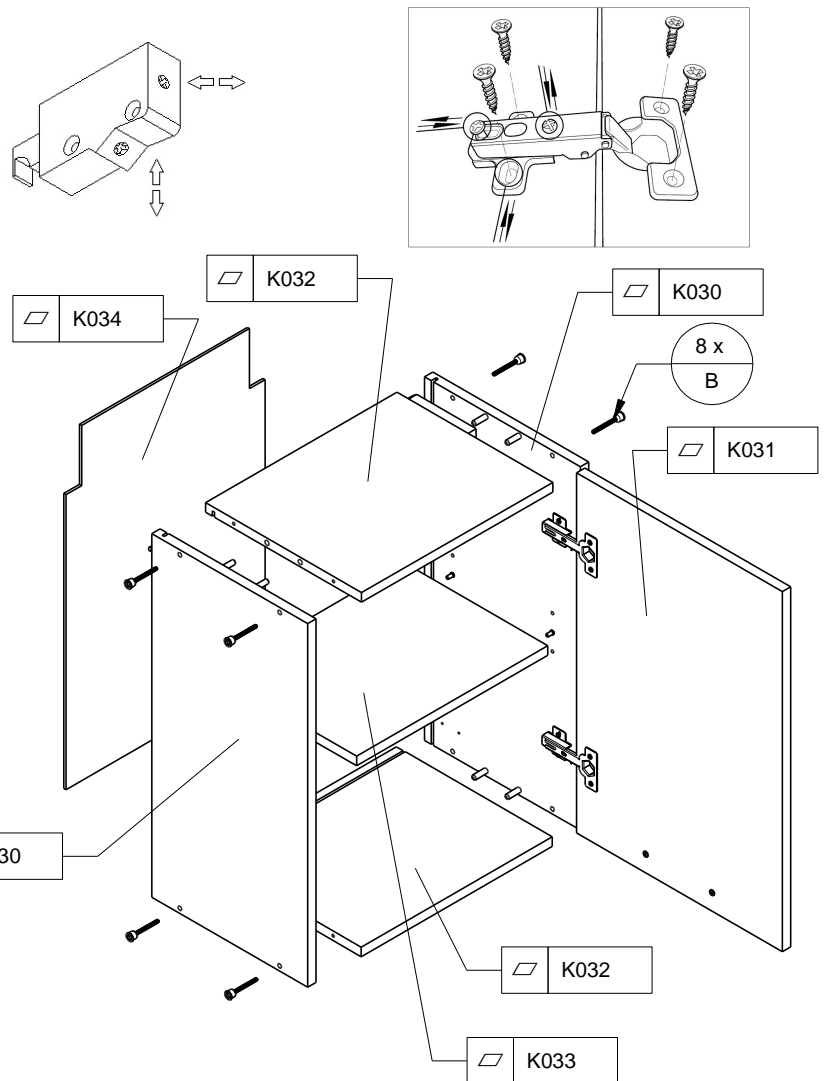



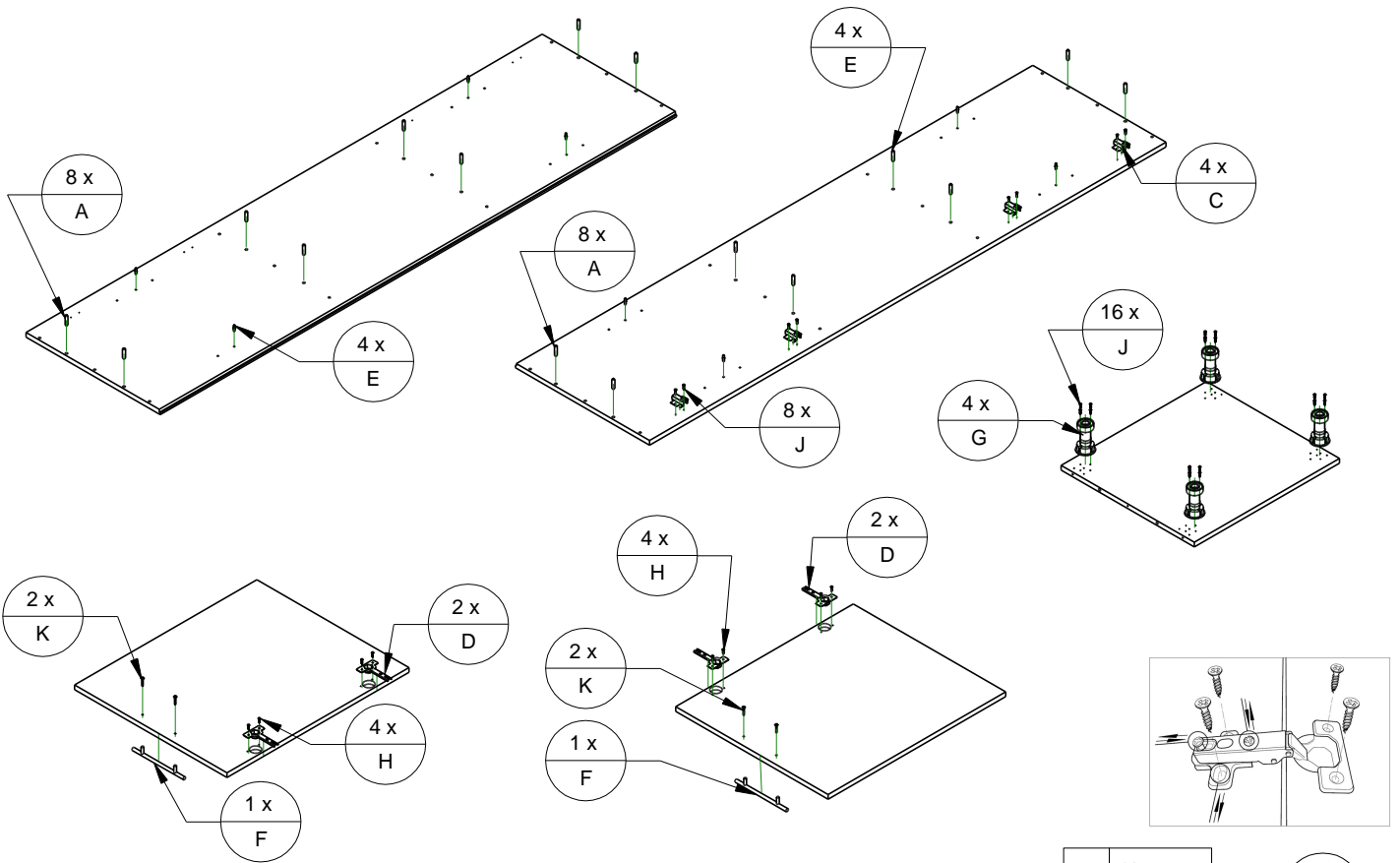

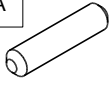

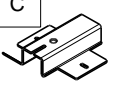
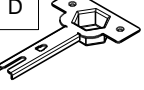
A		x8	B		x8	C		x1			
D		x2	E		x2	F		x2			
G		$\varnothing 3,5$ 16	x4	H		$\varnothing 4$ 16	x4	J		$\varnothing 4$ 30	x4
K		x2	L		x4	M					

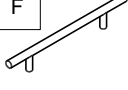

DK60 - SŁUPEK



A  x16	B  x24	C  x4
D  x4	E  x8	F  x2
G  x4	H  x8	J  x24
K  x4	L  x50	M

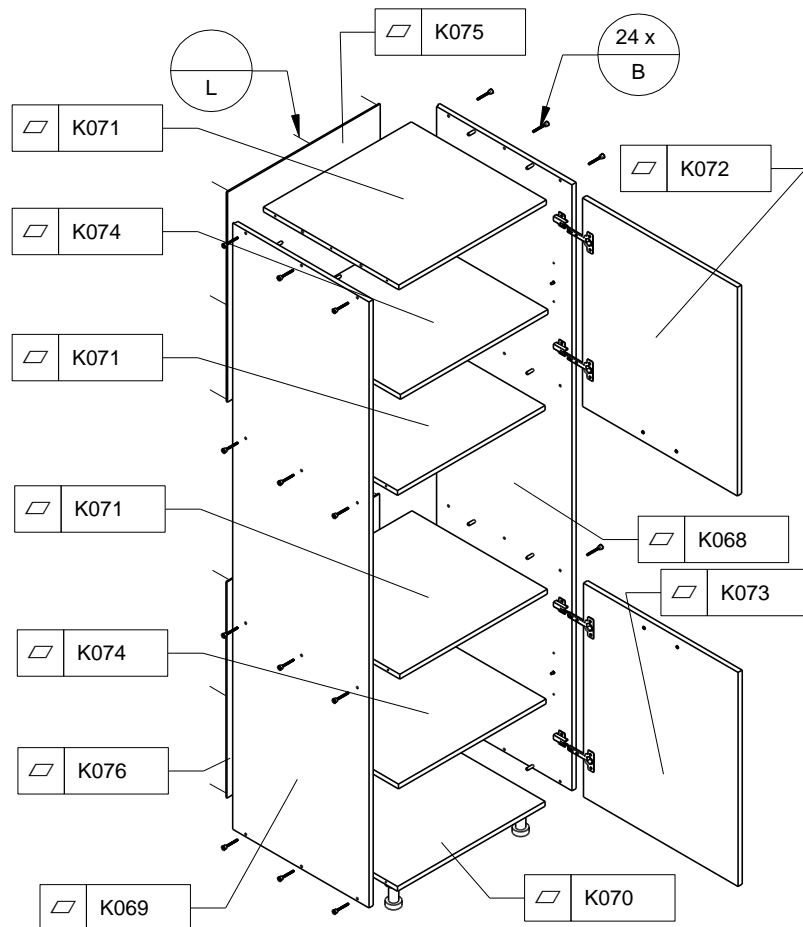

D 80 3sz

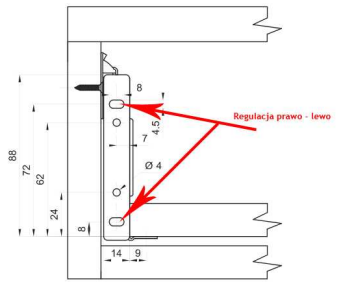
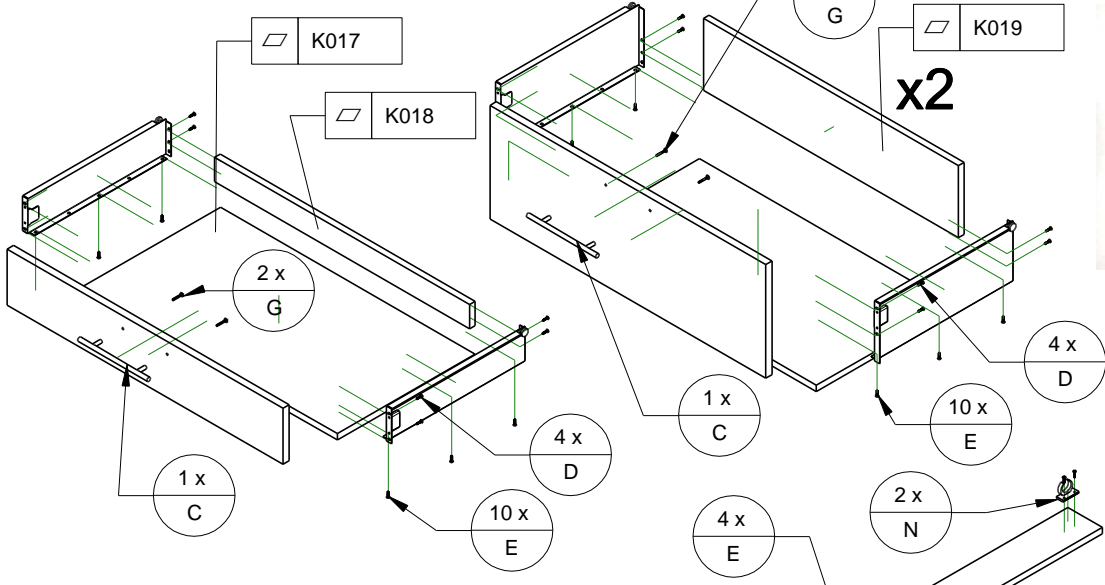
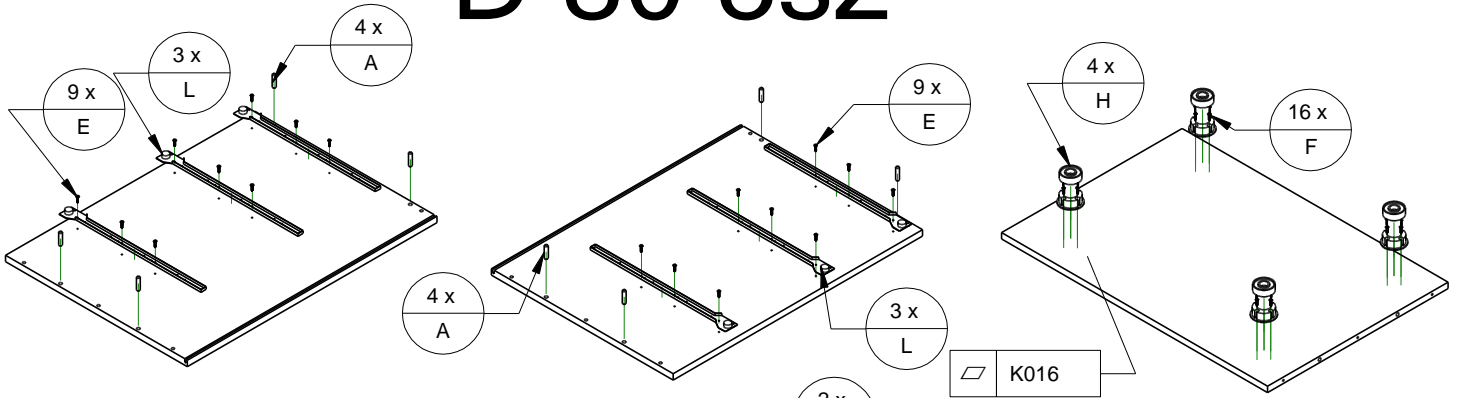

A	B	C
x8	x10	x3
D	E	F
$\varnothing 3$ x12	$\varnothing 3,5$ x52	$\varnothing 4$ x16
G	H	J
x6	x4	x2
K	L	M
x4	x6	x20
N	P	R
x2		

