

Ax4

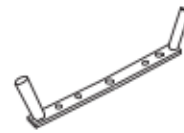

B₁x1



B₂x1



Cx1



Dx1



Ex1

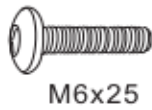

Fx16



Hx4



Jx9



Kx8



Mx4



L₁x1

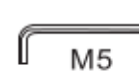

L₂x1

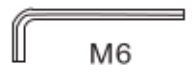

Ex1



Fx8



Jx9



L₂x1

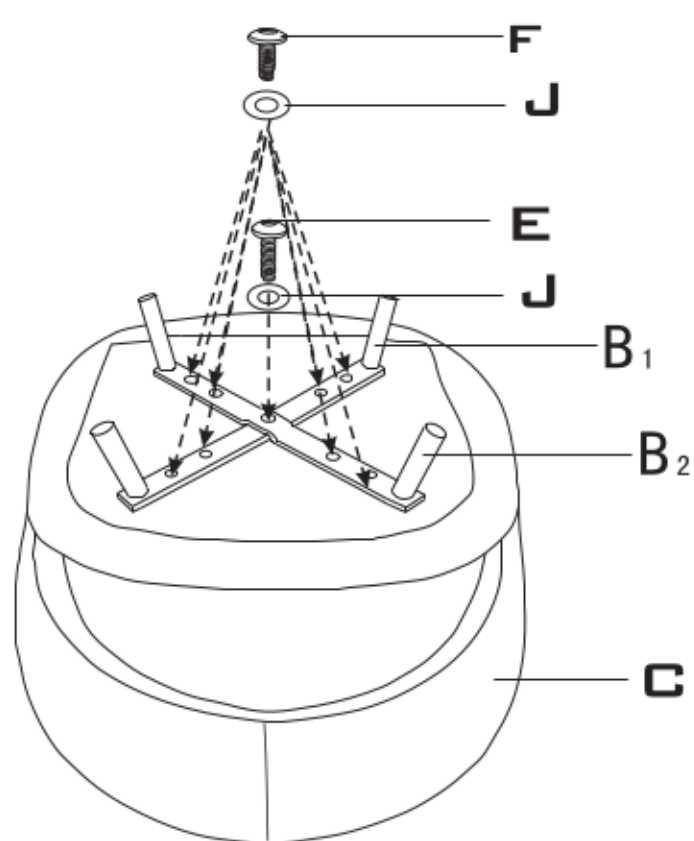
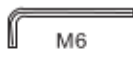

F x 8
M6x18

2

K x 8
M6x14

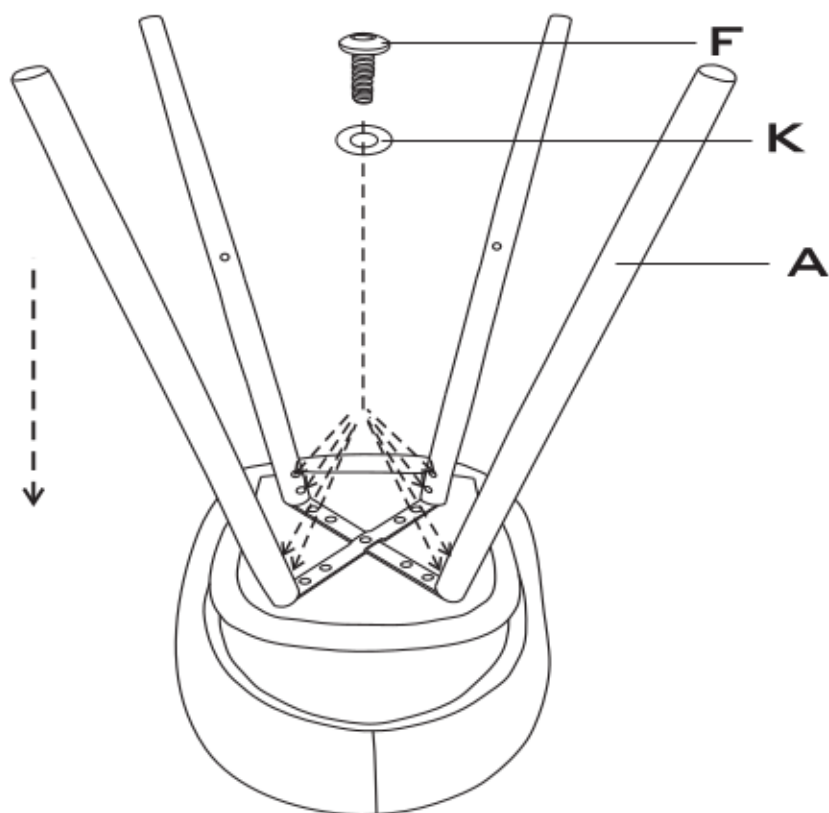

H x 4
M6x30

L₁ x 1
M5

M x 4

