



Matis

NAMEŠTAJ • www.matis.rs

Senjak bb*32250 Ivanjica*Srbija

Tel:032 651 159* Fax:032 651 060



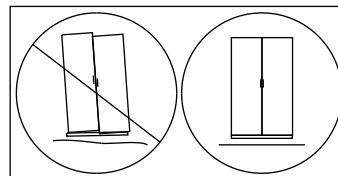
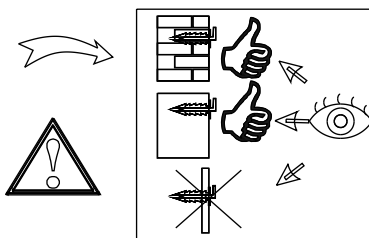
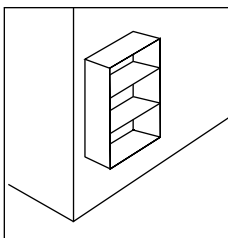
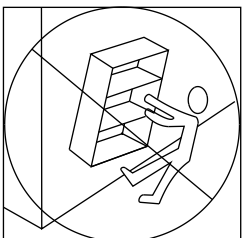
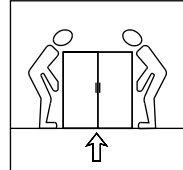
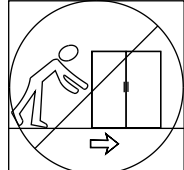
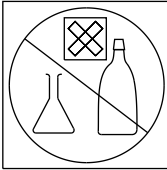
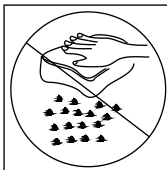
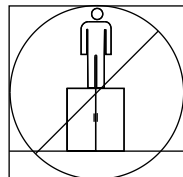
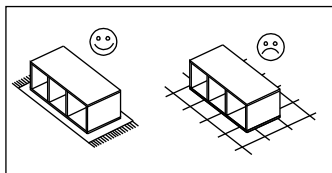
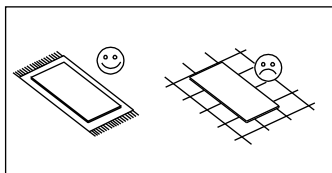
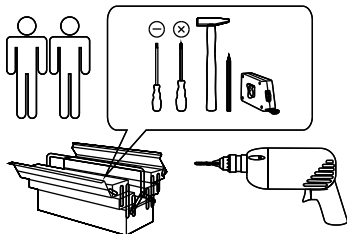
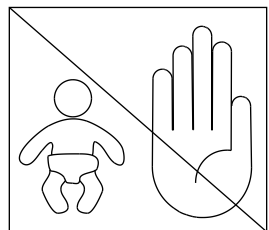

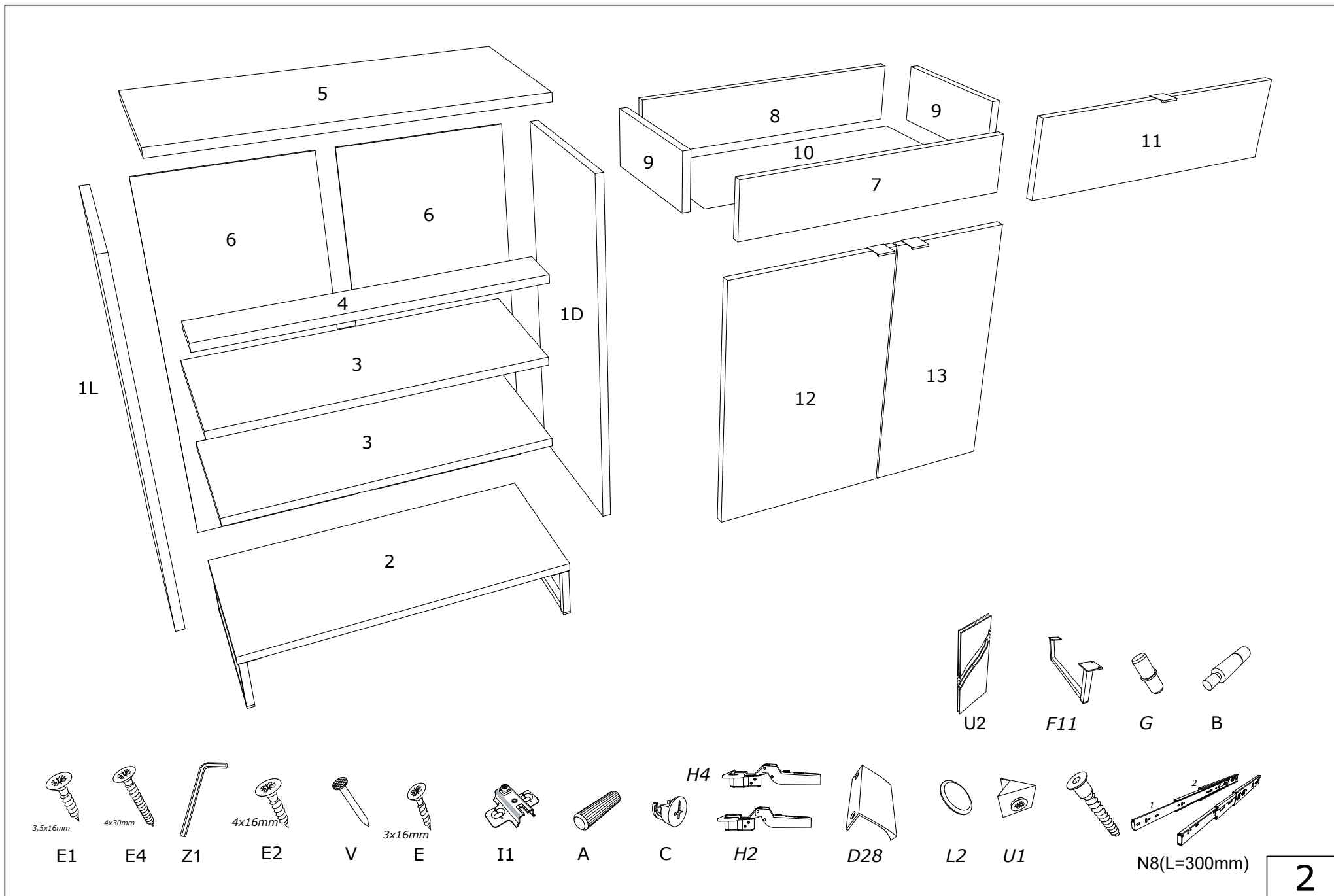

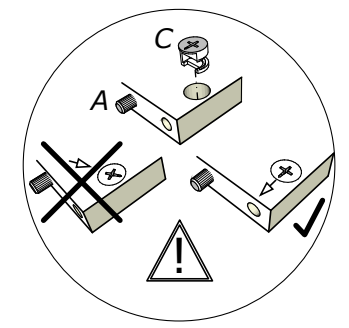
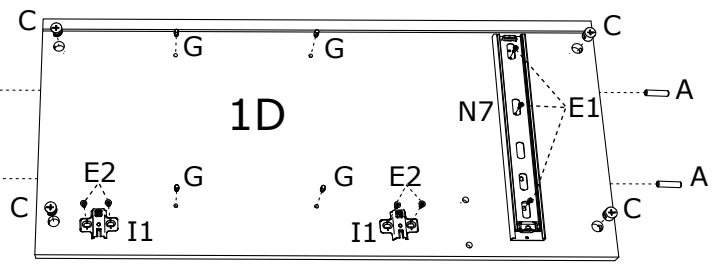
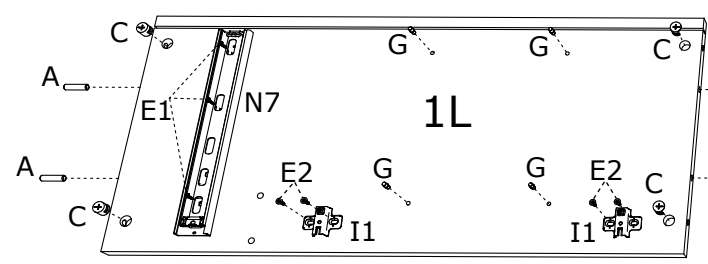
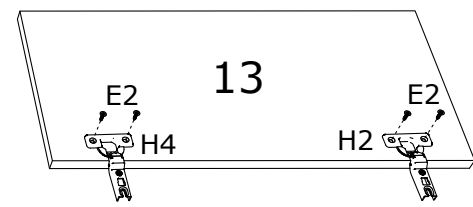
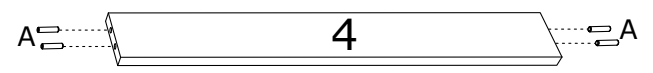
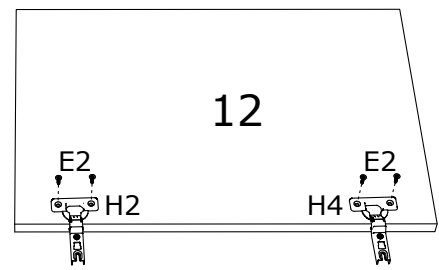
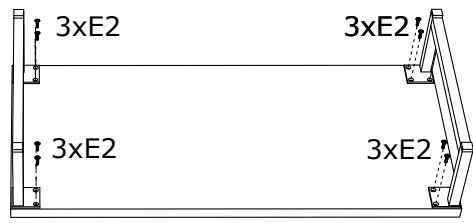
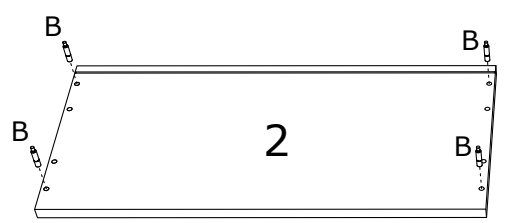
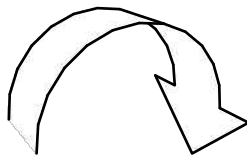

office@matis.rs*veleprodaja@matis.rs*www.matis.rs





PREDSOBLJE DENVER CIPELAR

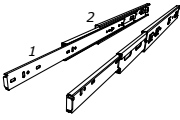

- 
 3,5x16mm
E1
- 
 4x16mm
E2
- 
I1
- 
A
- 
C
- 
H4
- 
H2
- 
B
- 
G
- 
N8(L=300mm)

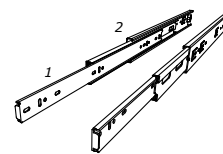
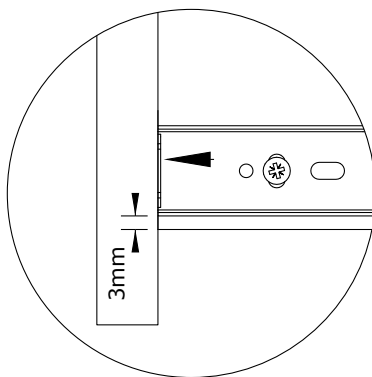
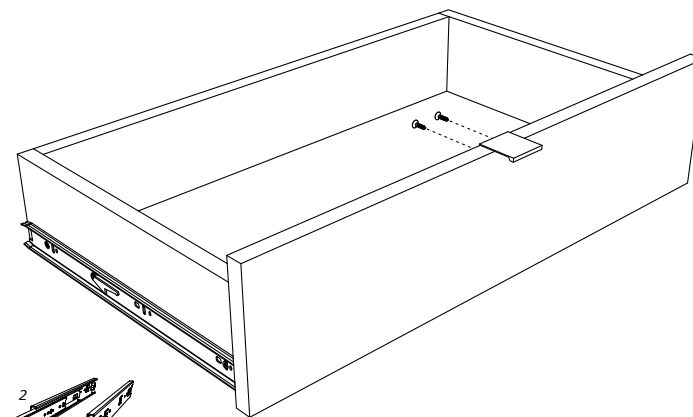
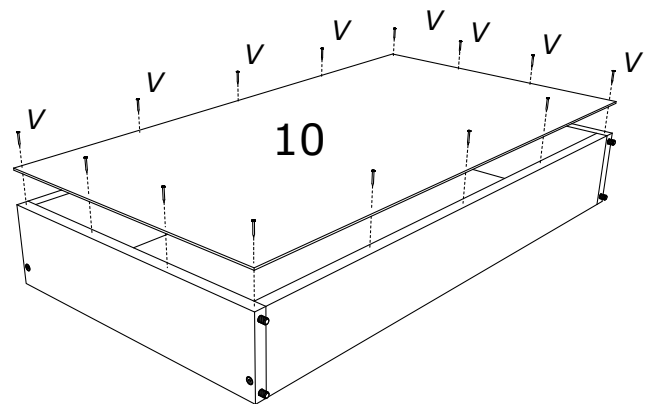
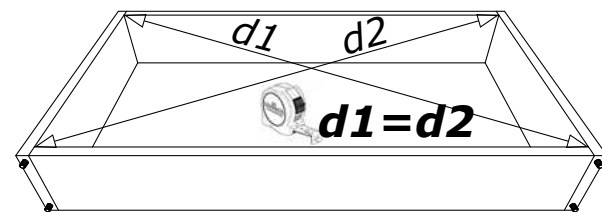
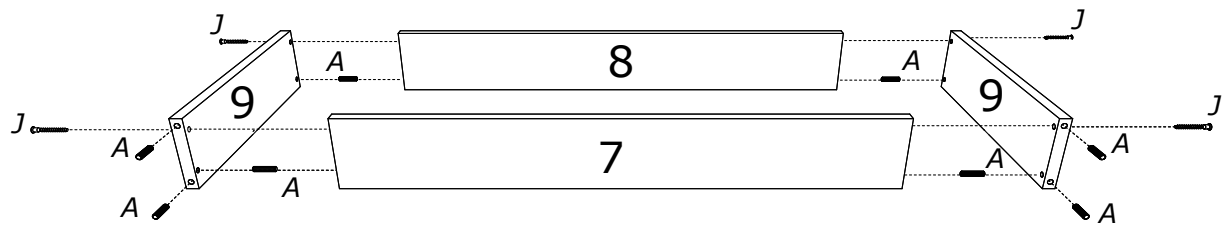

N8(L=300mm)

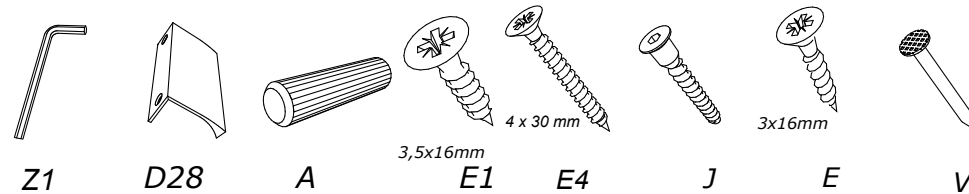
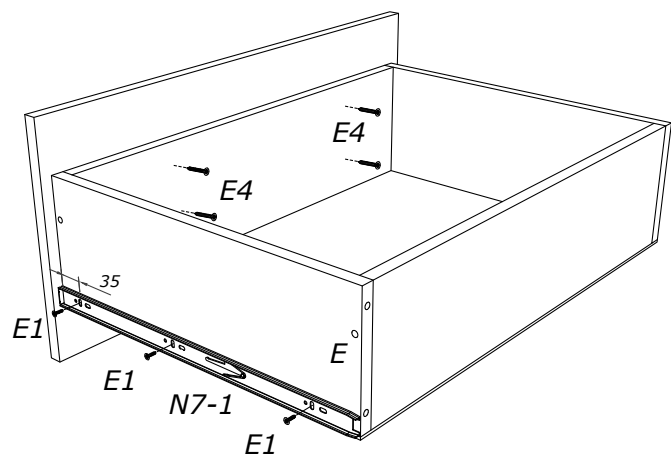

Z1

D28

A

3,5x16mm

E1

E4

J

E

V

