

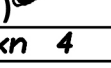





# NUBRE

<i>pr</i> 1	L50	
(G) 2	<i>kn</i> 4	(E) 
(I) 	(H) 	(F)  3,5x16
<i>ku</i> 8	<i>h1</i> 4	<i>w1</i> 30

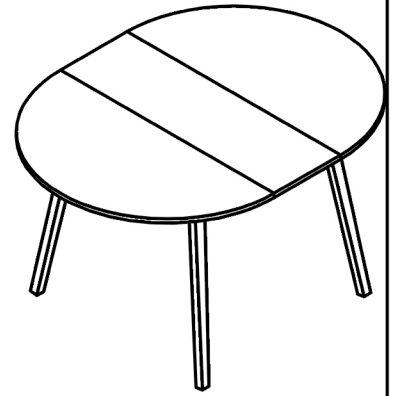
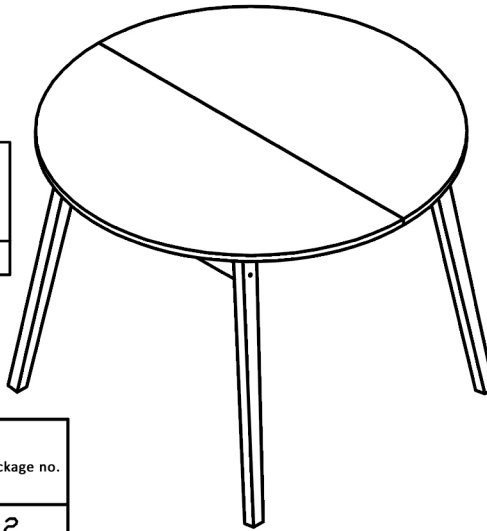
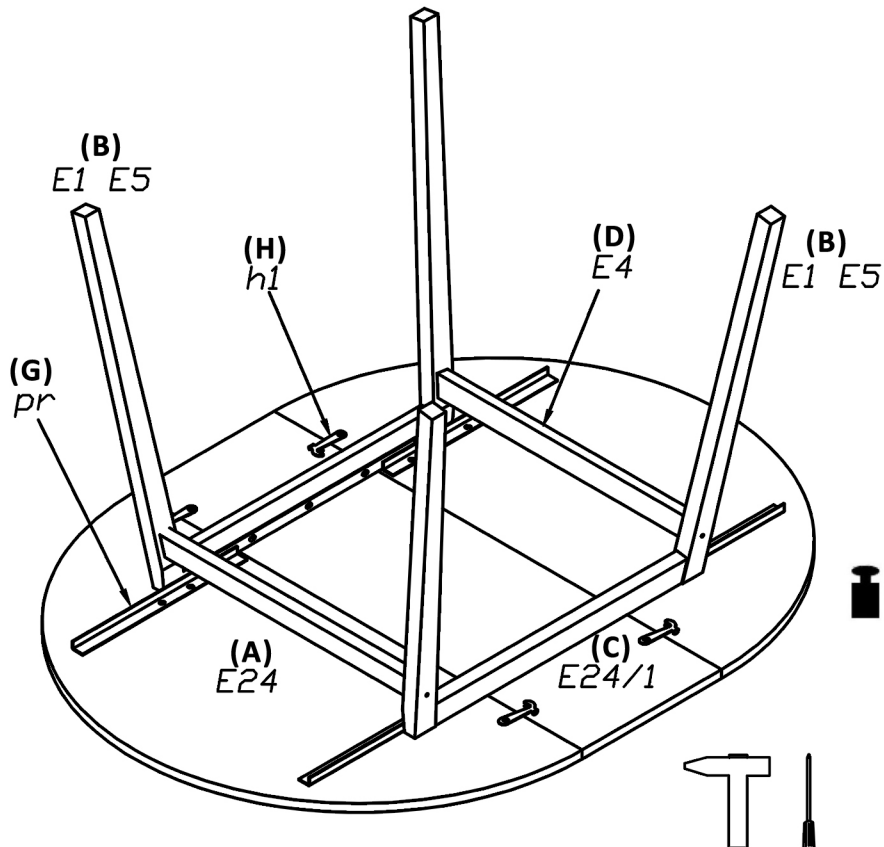

Parts list	pcs.	package no.
(B) E1 E5	2	2
(A) E24	2	1
(C) E24/1	1	1
(D) E4	2	2
(E) <i>kn</i>	4	1
(F) <i>w1</i>	30	1
(G) <i>pr</i>	2	1
(H) <i>h1</i>	4	1
(I) <i>ku</i>	8	1



 max. 40 kg



