

RM 16

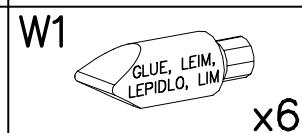

1

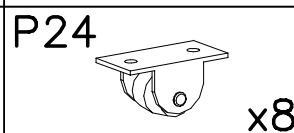
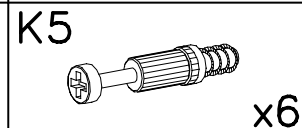
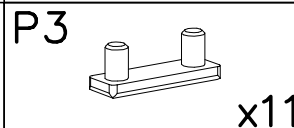
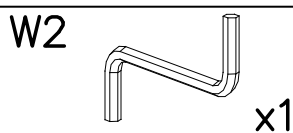
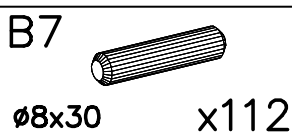
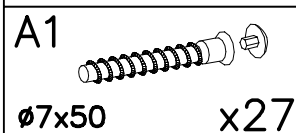
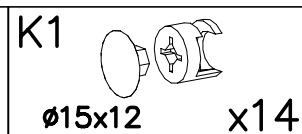
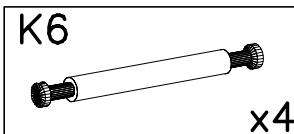
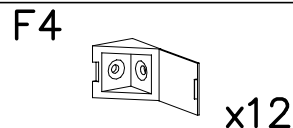
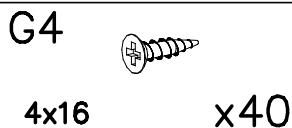
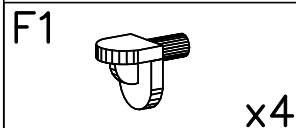
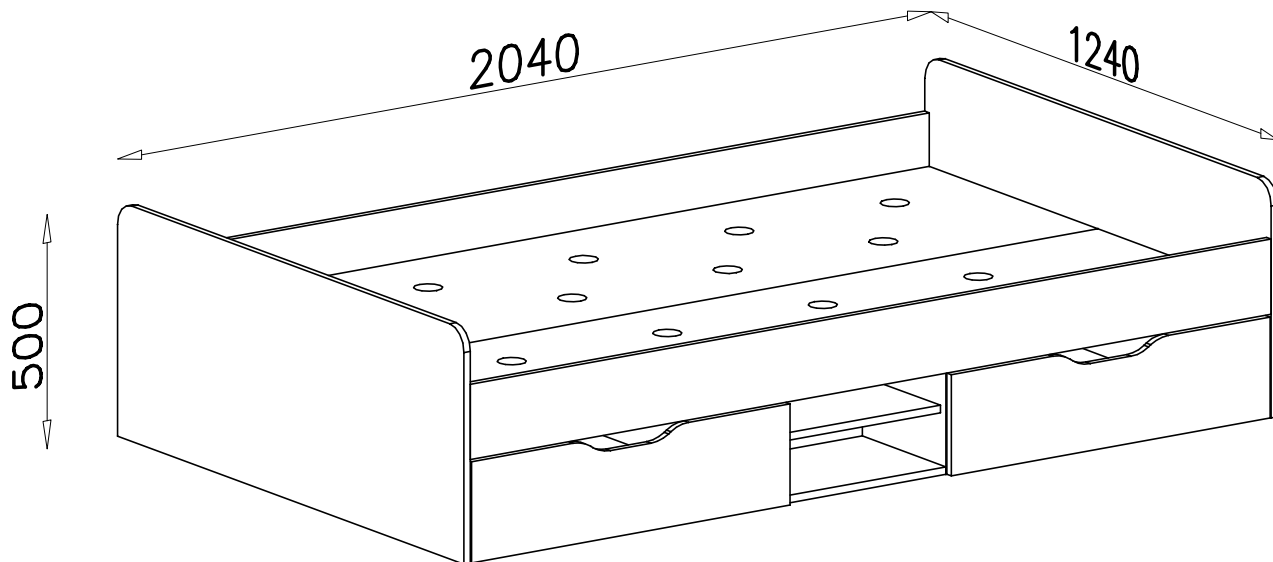
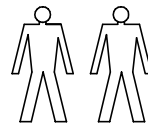
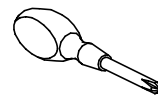
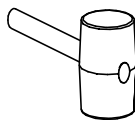
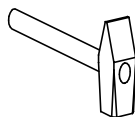
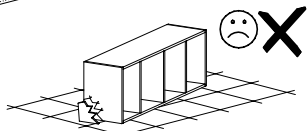
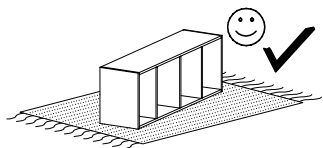
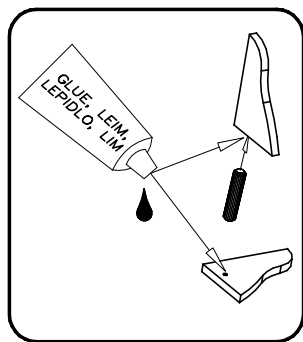
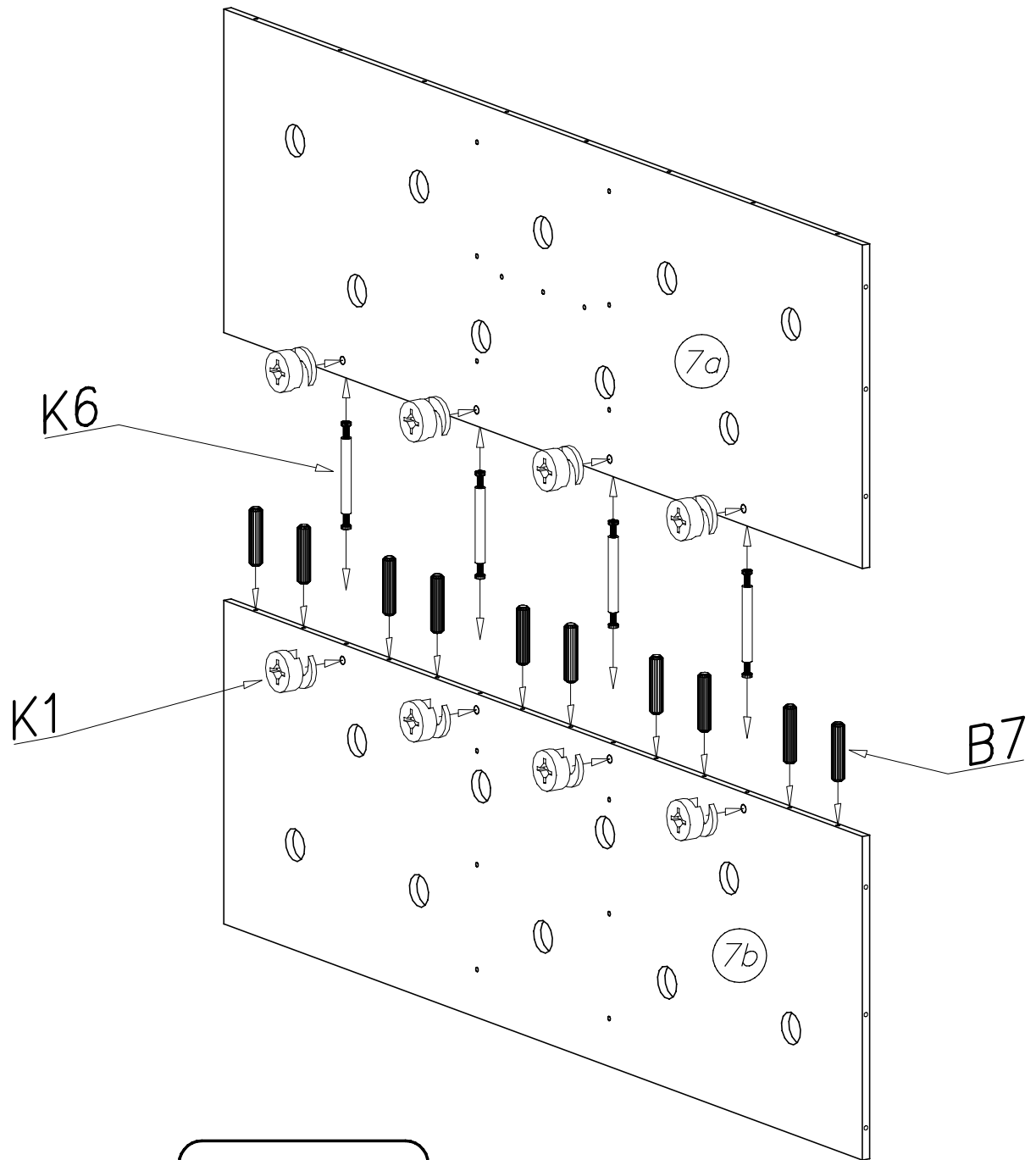

II

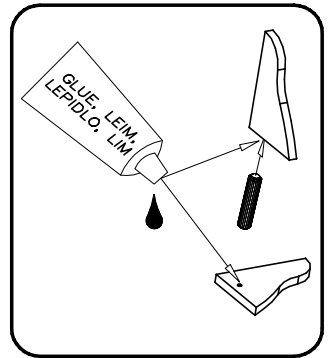
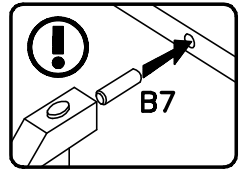
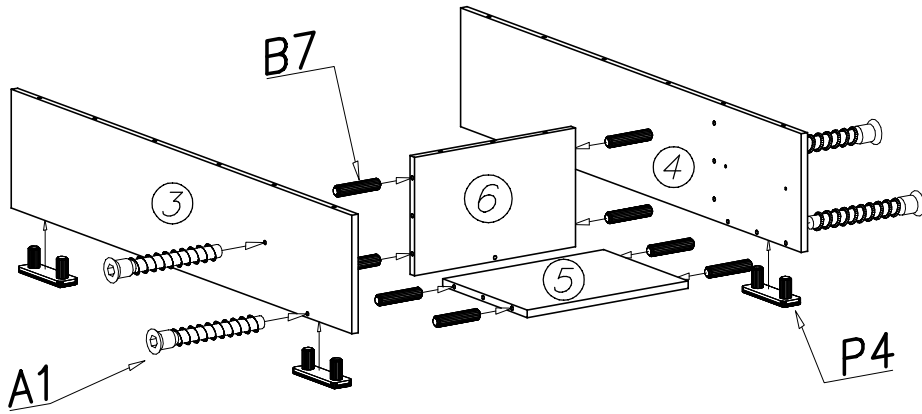

III

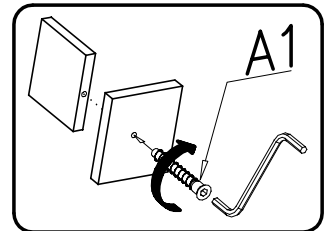
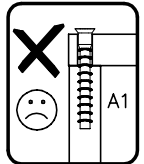
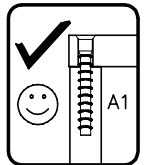
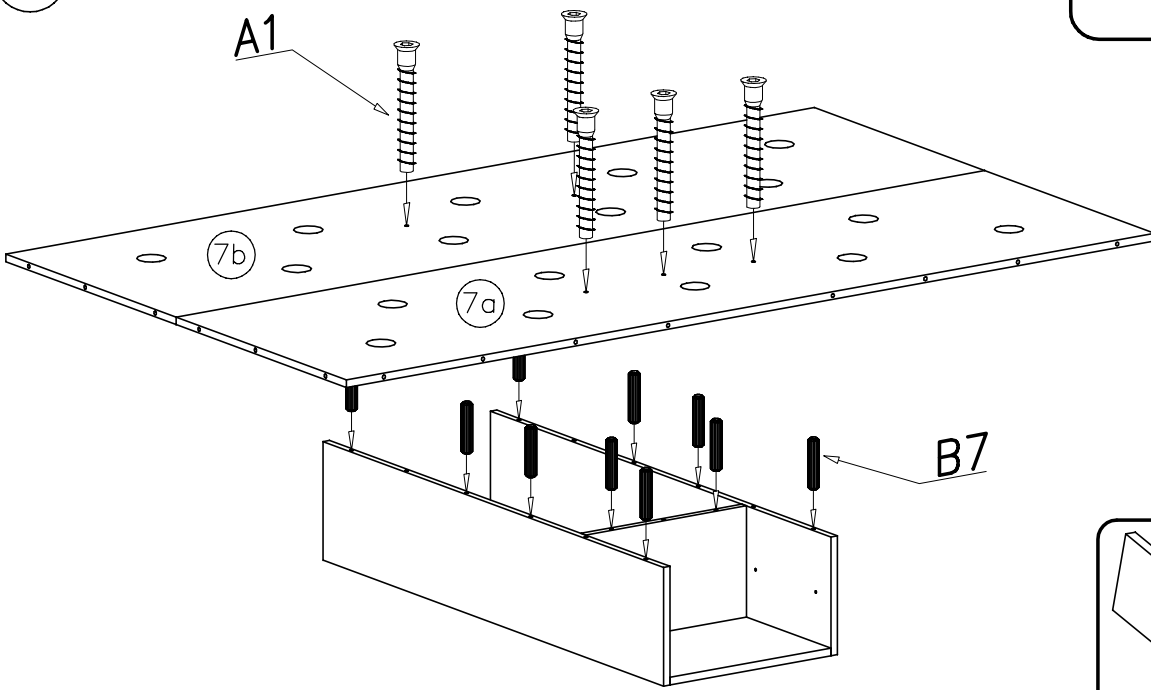

IV

