

RM 15

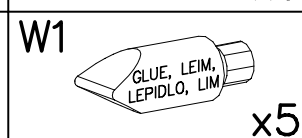

I

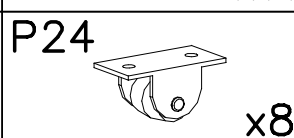
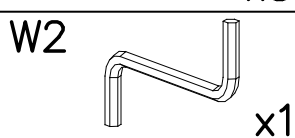
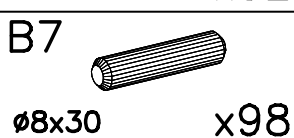
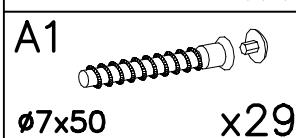
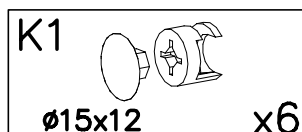
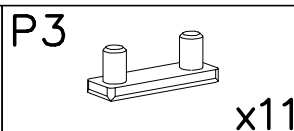
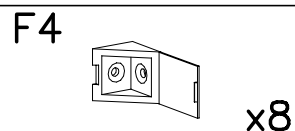
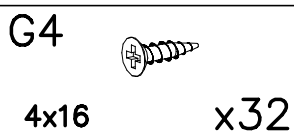
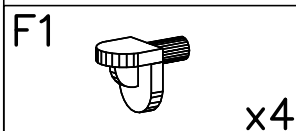
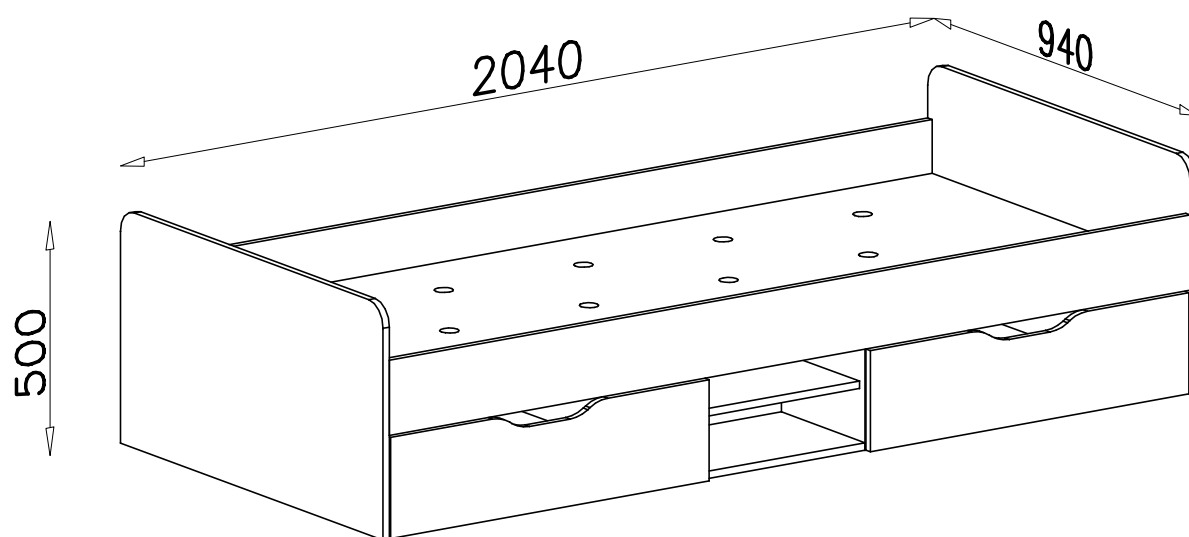
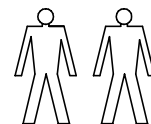
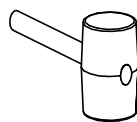
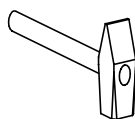
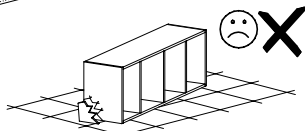
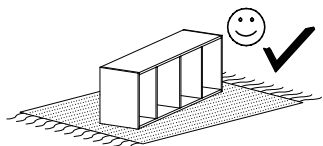
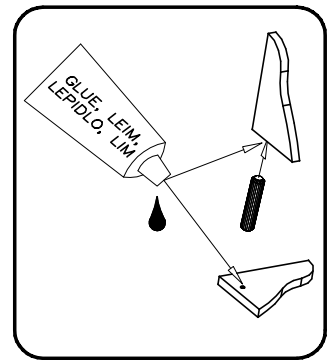
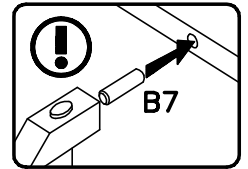
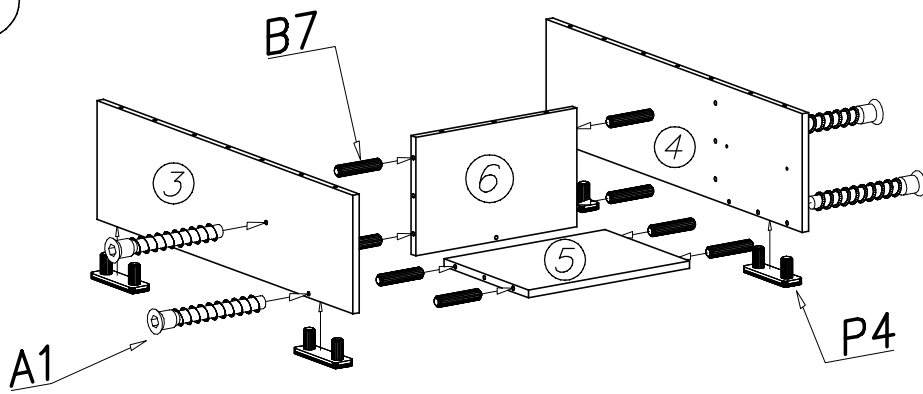

II

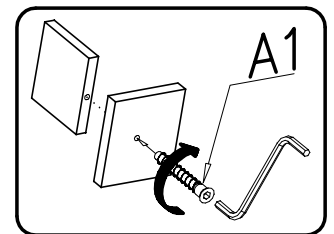
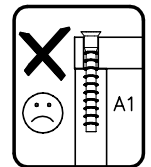
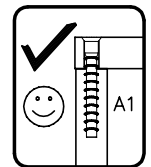
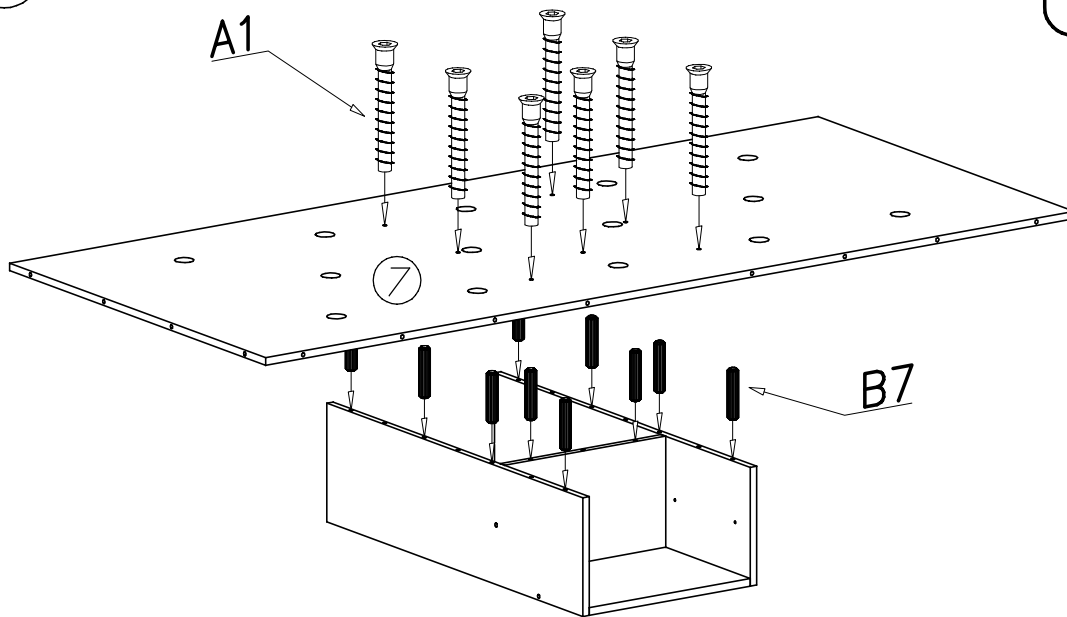

III

