

# RM 14

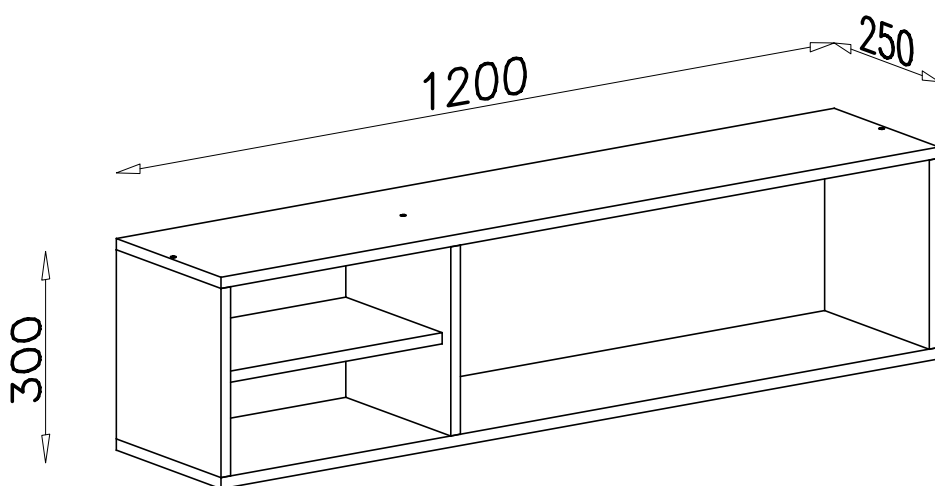

U4

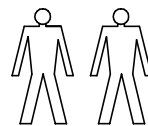
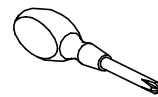
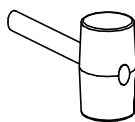
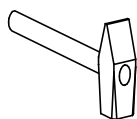
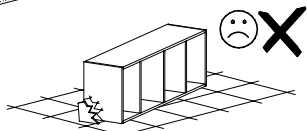
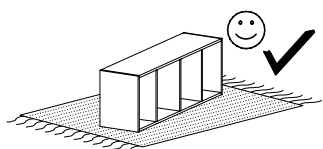
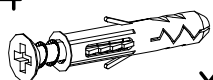

x4

W1



x1

G2

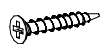

3x20

x25

G3

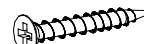

4x30

x4

F1



x4

A1



ø7x50

x6

B7



ø8x30

x12

W2

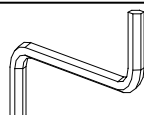

x1

U14

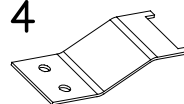

x2

U13

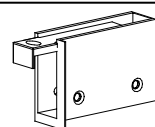

x2

I

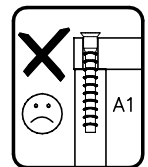
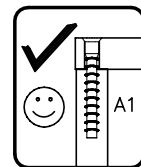
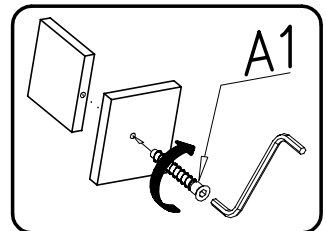
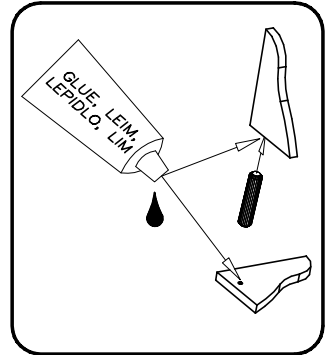
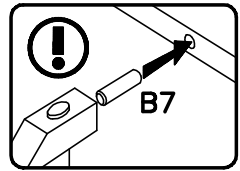
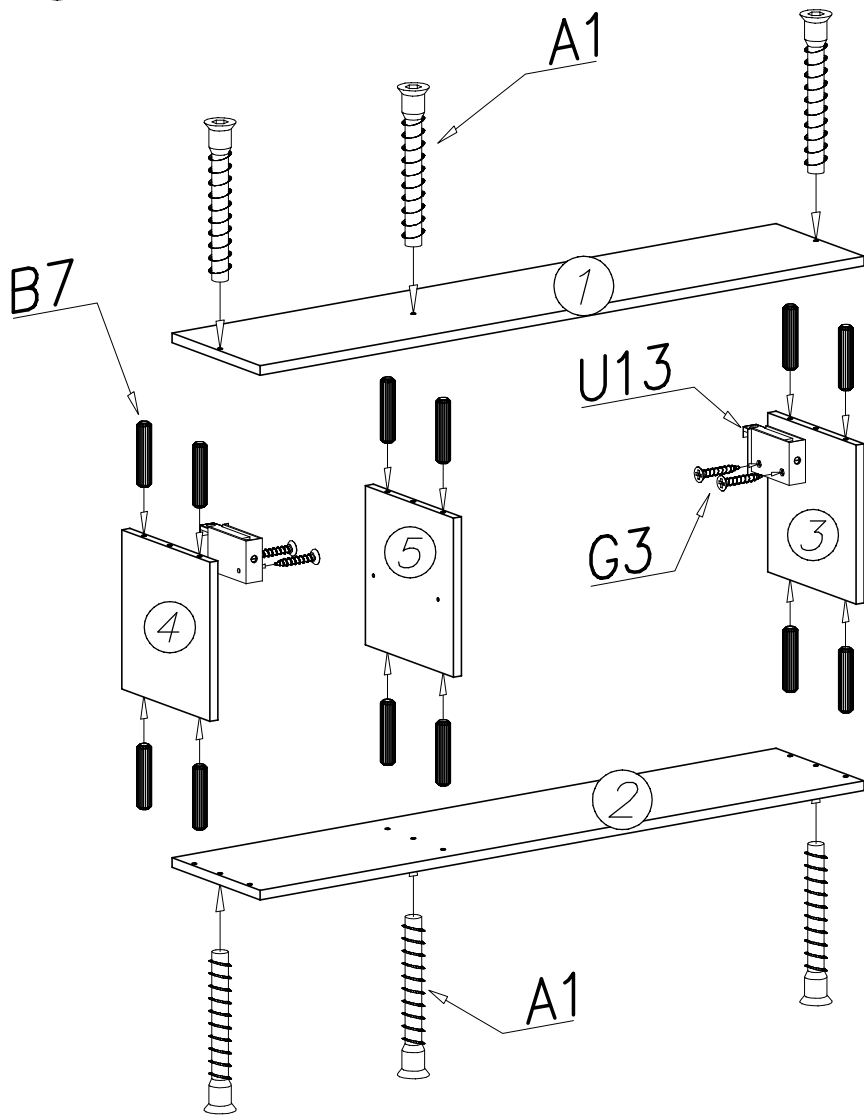

II

