

# RM 2

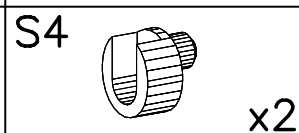

I

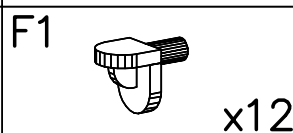
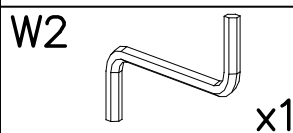
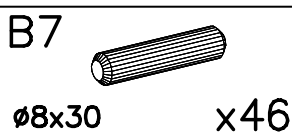
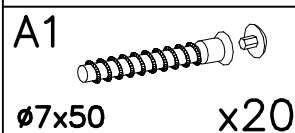
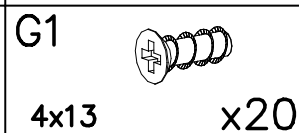
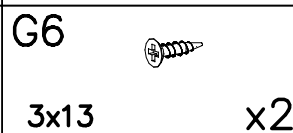
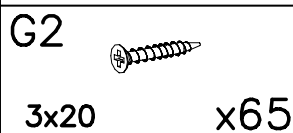
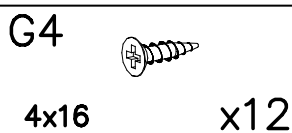
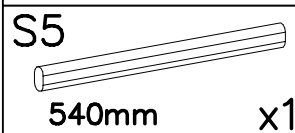
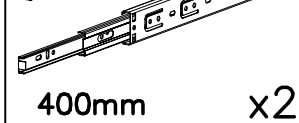
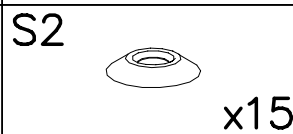
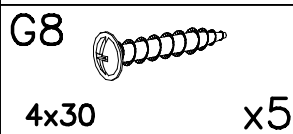
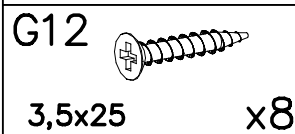
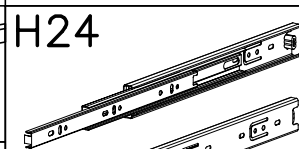
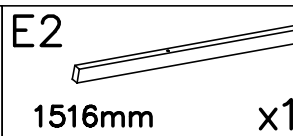
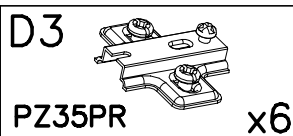
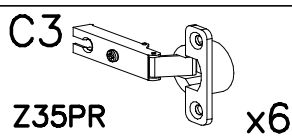
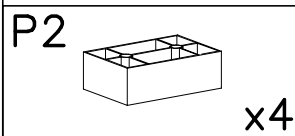
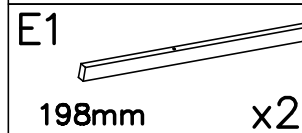
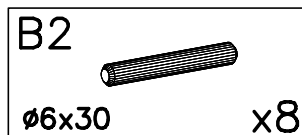
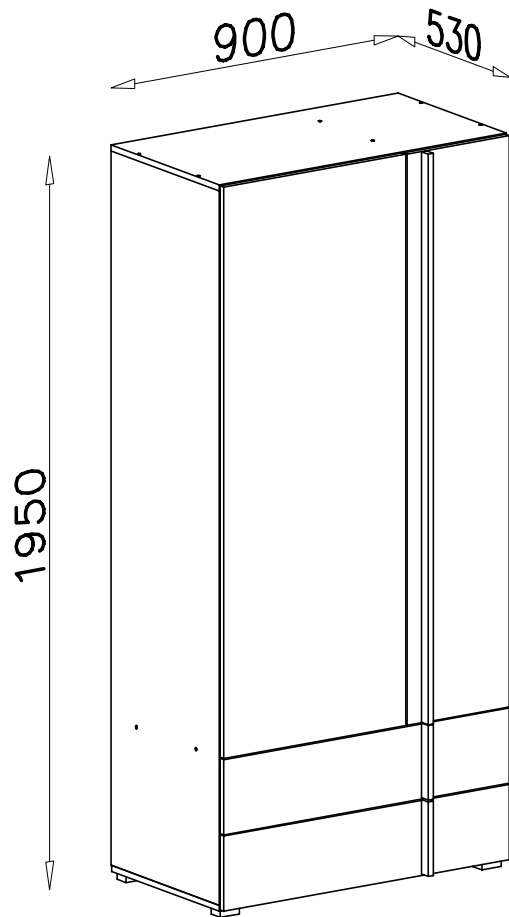
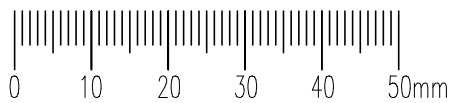
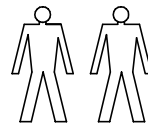
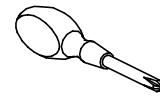
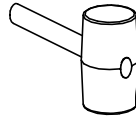
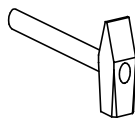
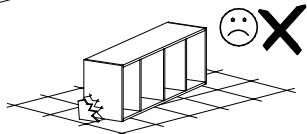
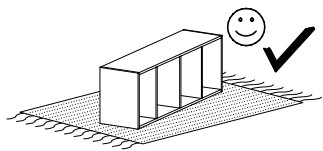
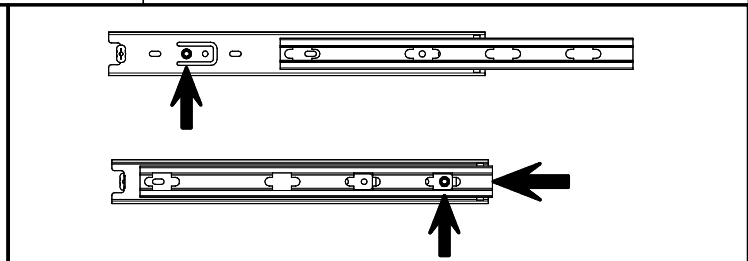
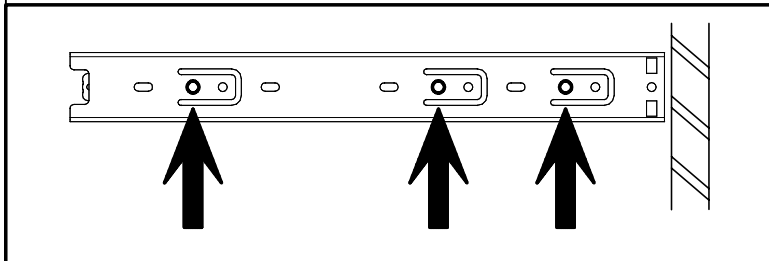
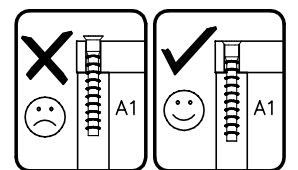
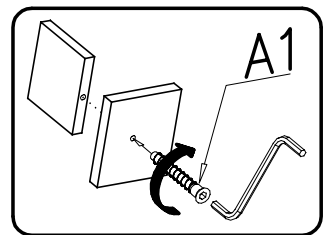
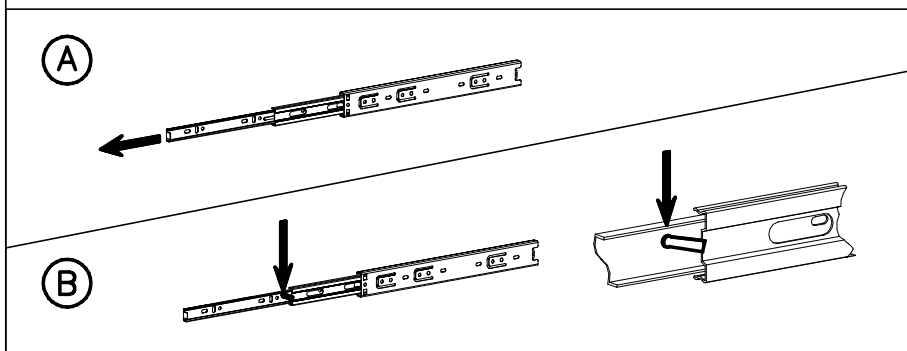
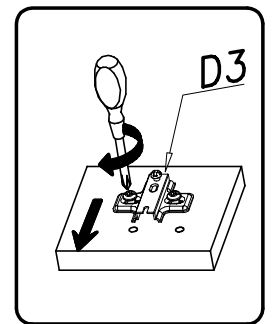
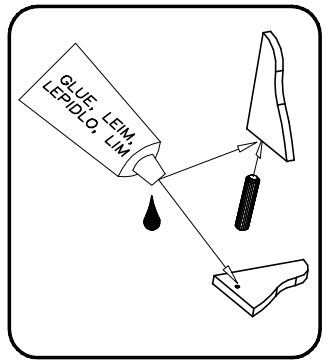
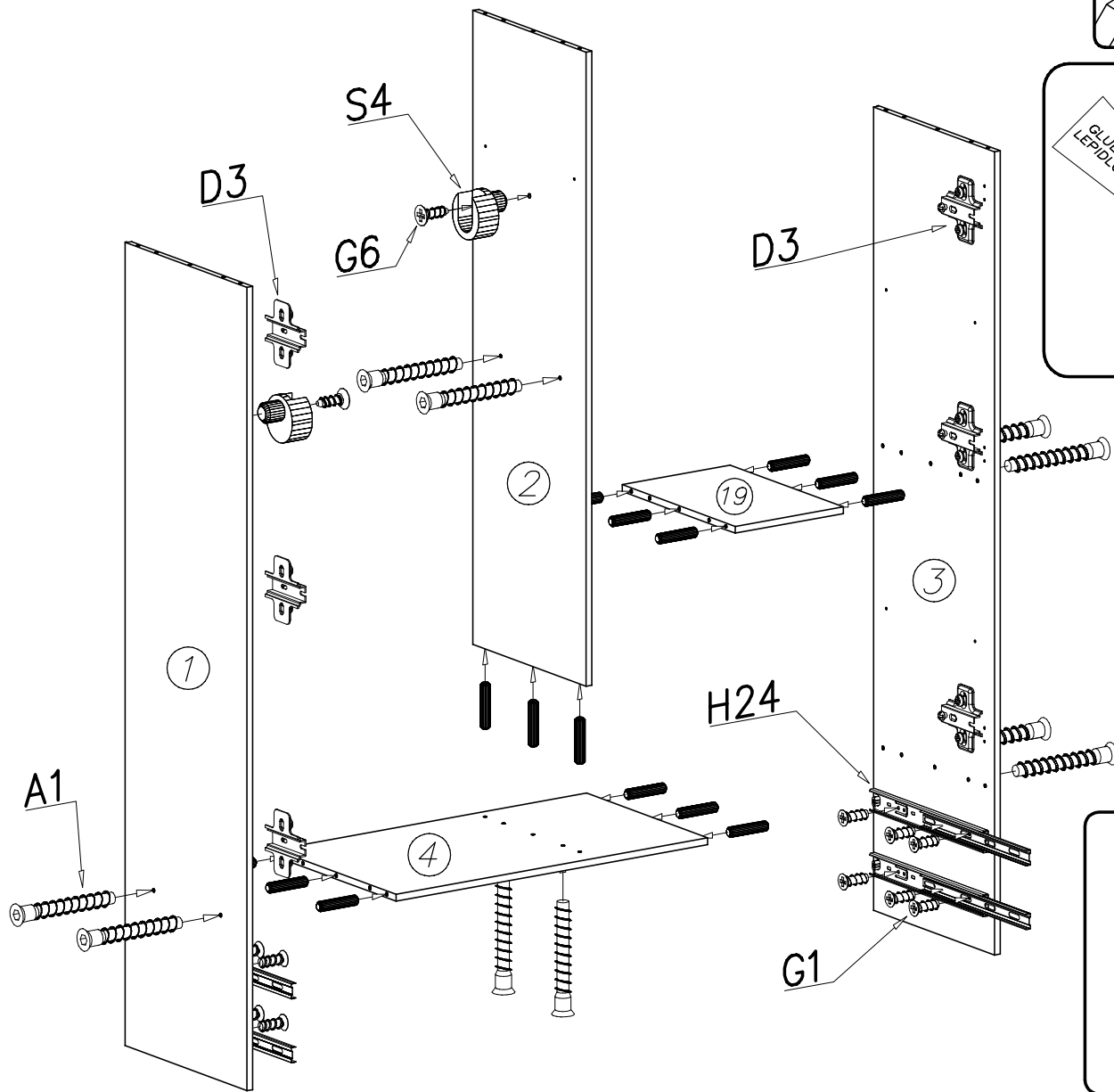

II

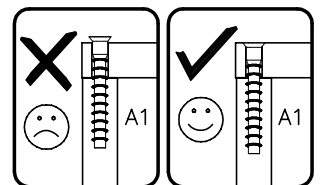
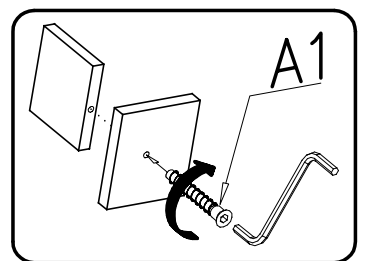
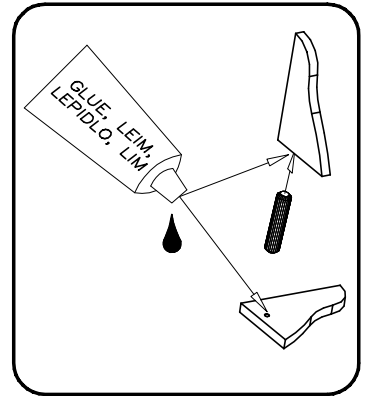
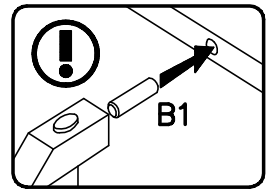
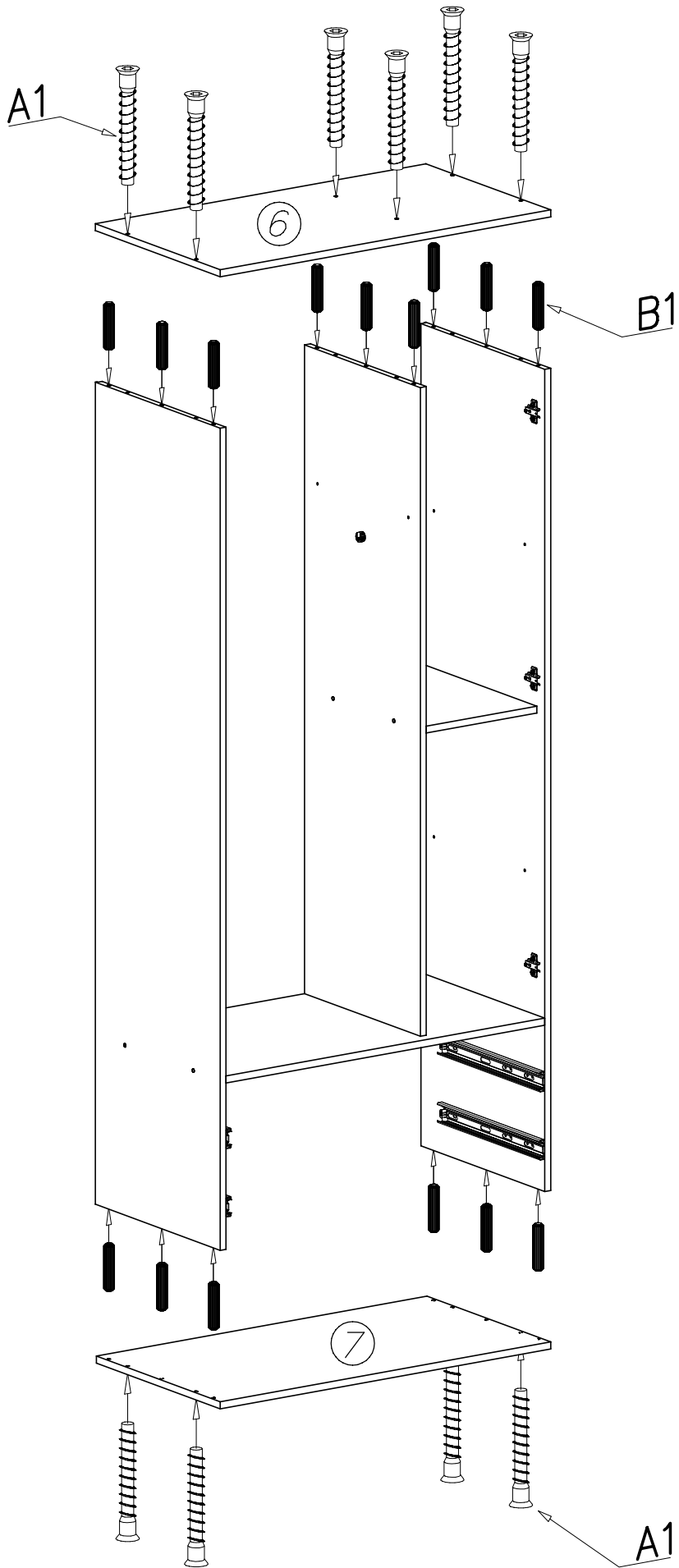

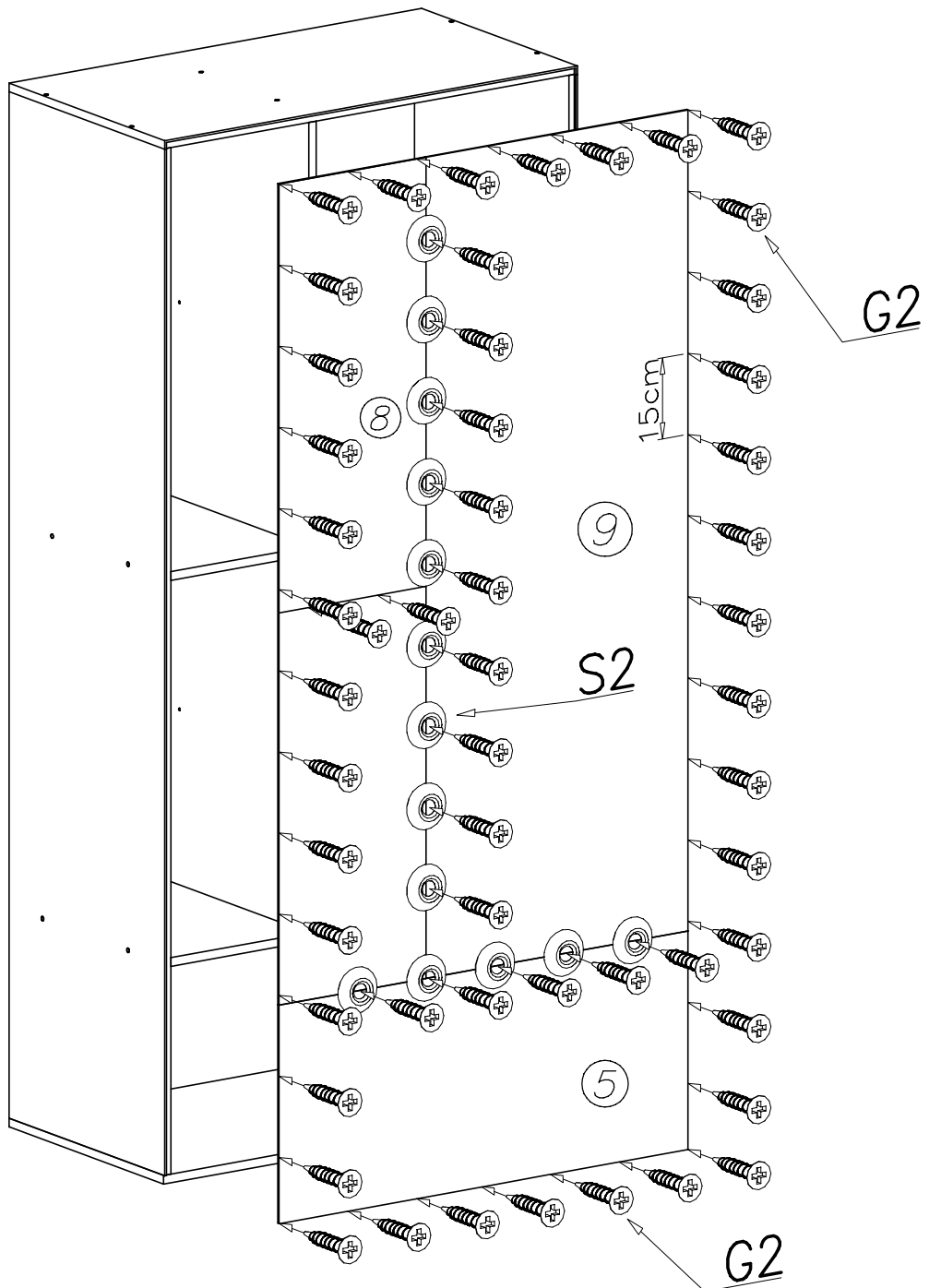
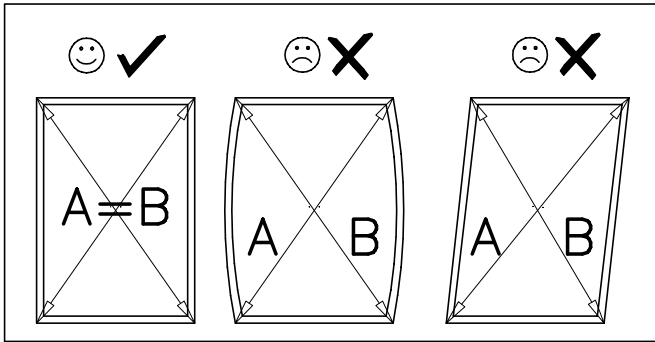

IV

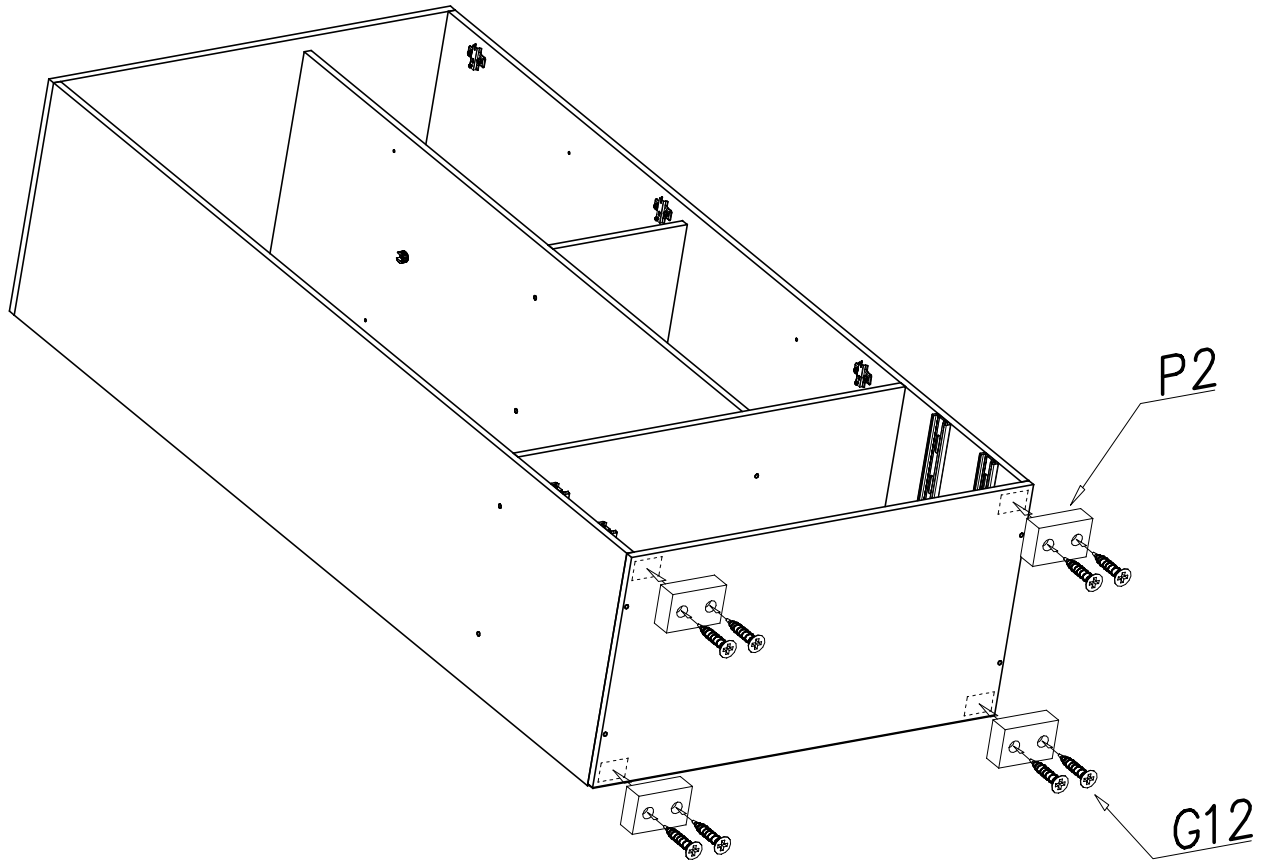

V

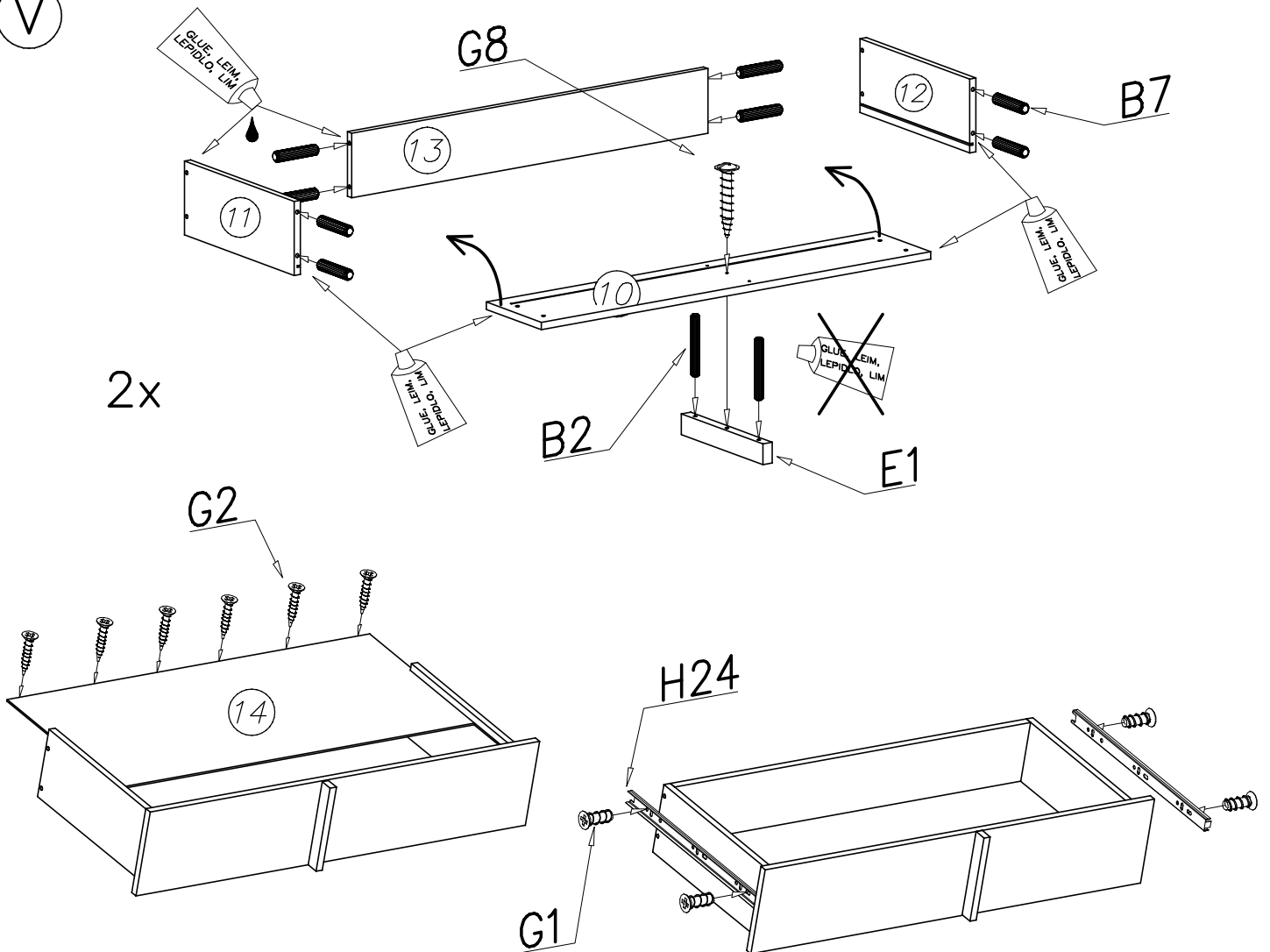

VI

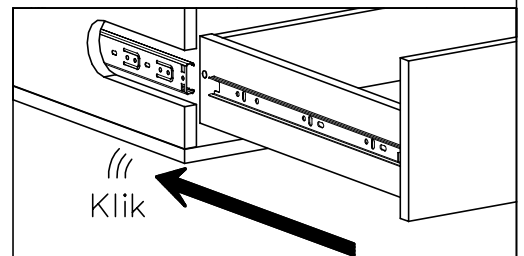
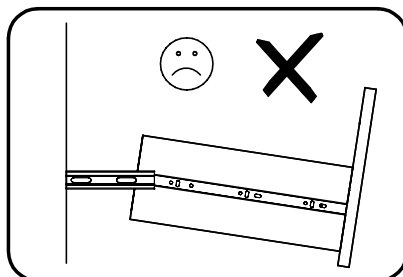
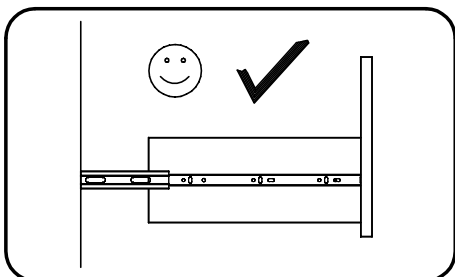
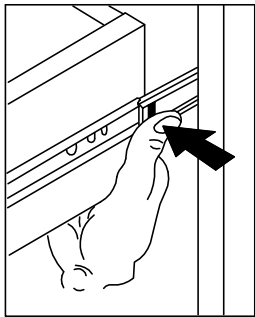
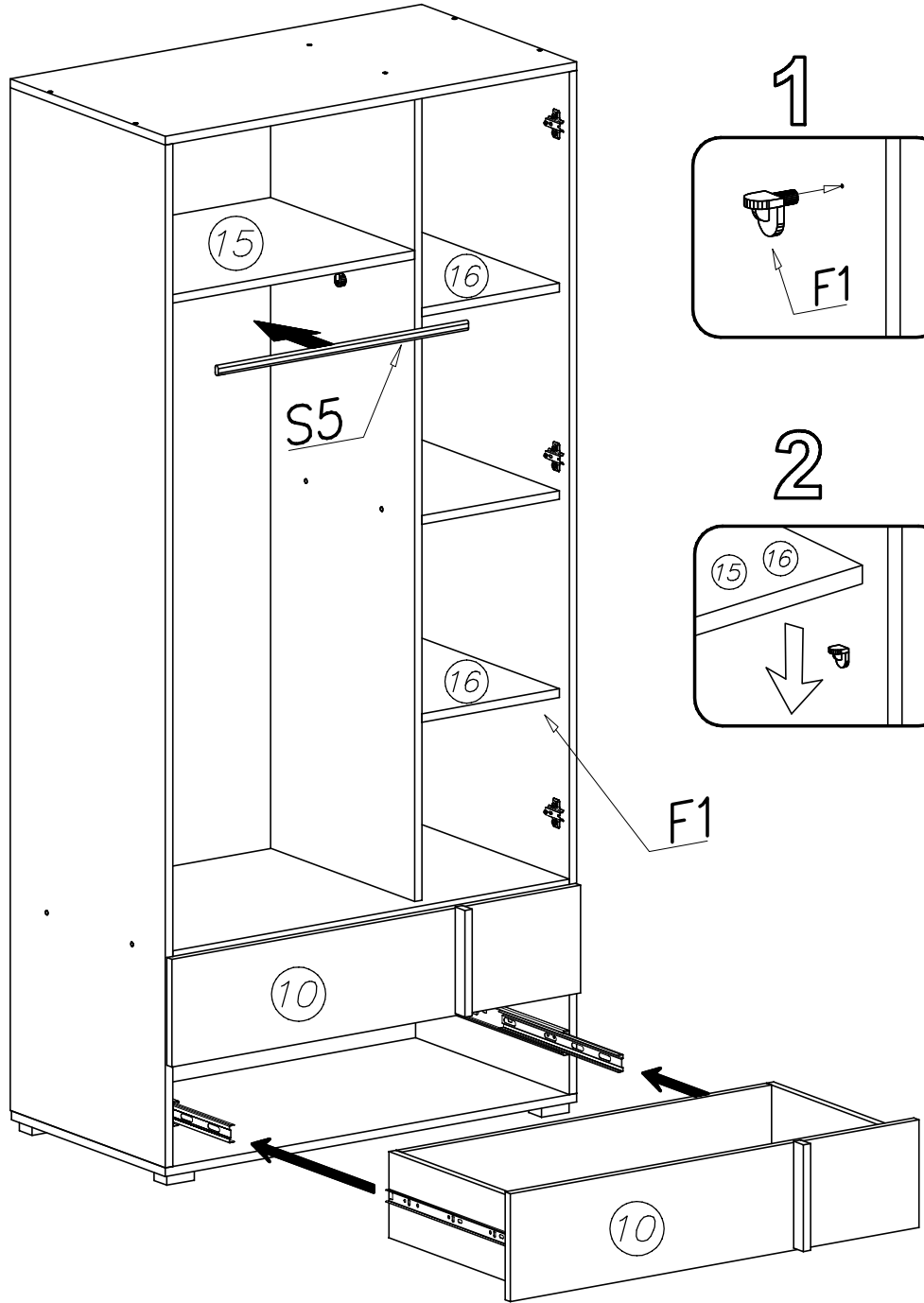
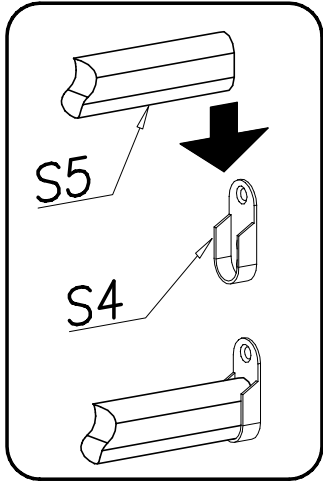

VII

