

G12  
3,5x25 x8

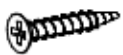

E38 x2



W1 x1



N13 M4x22 x2



D3 PZ35PR x4



H7 350mm x1

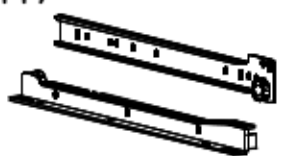

P15 x4



G4 4x16 x14



G2 3x20 x40



C3 Z350D x4

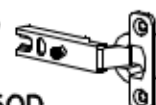

A1 ø7x50 x6

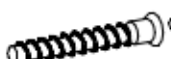

B7 ø8x30 x20



W2 x1

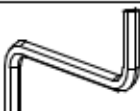

F1 x12



G10 6x13 x4



①

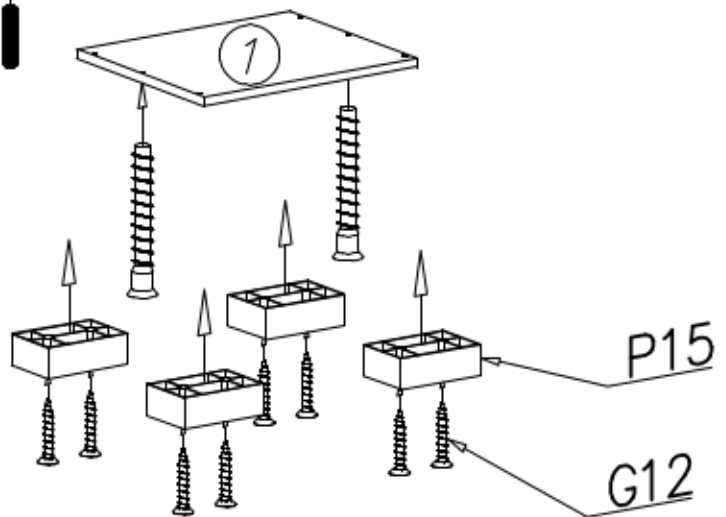
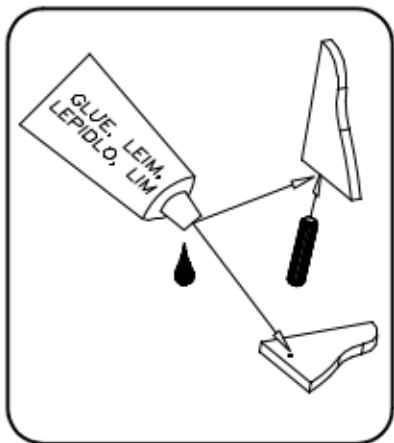
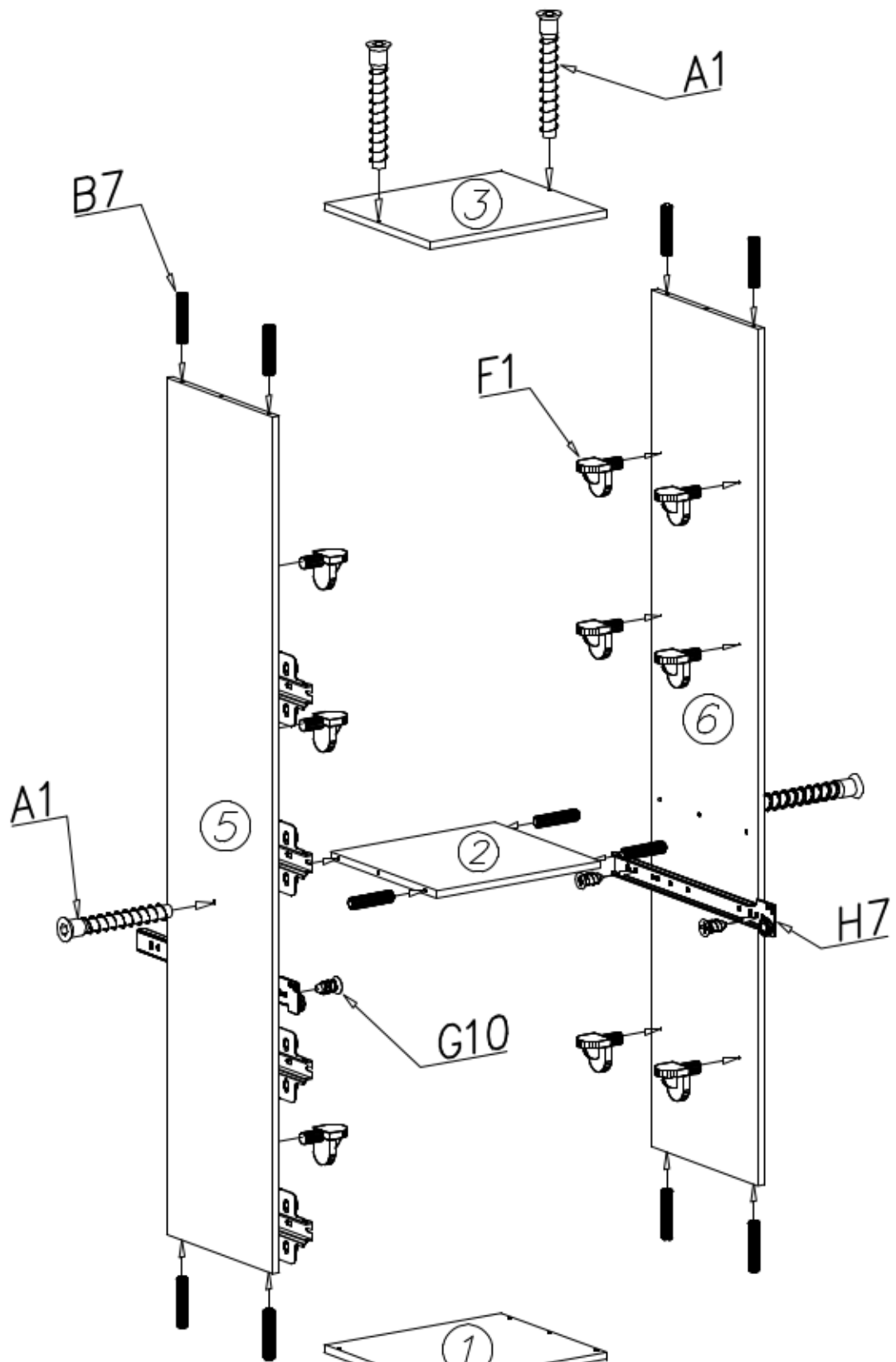

II

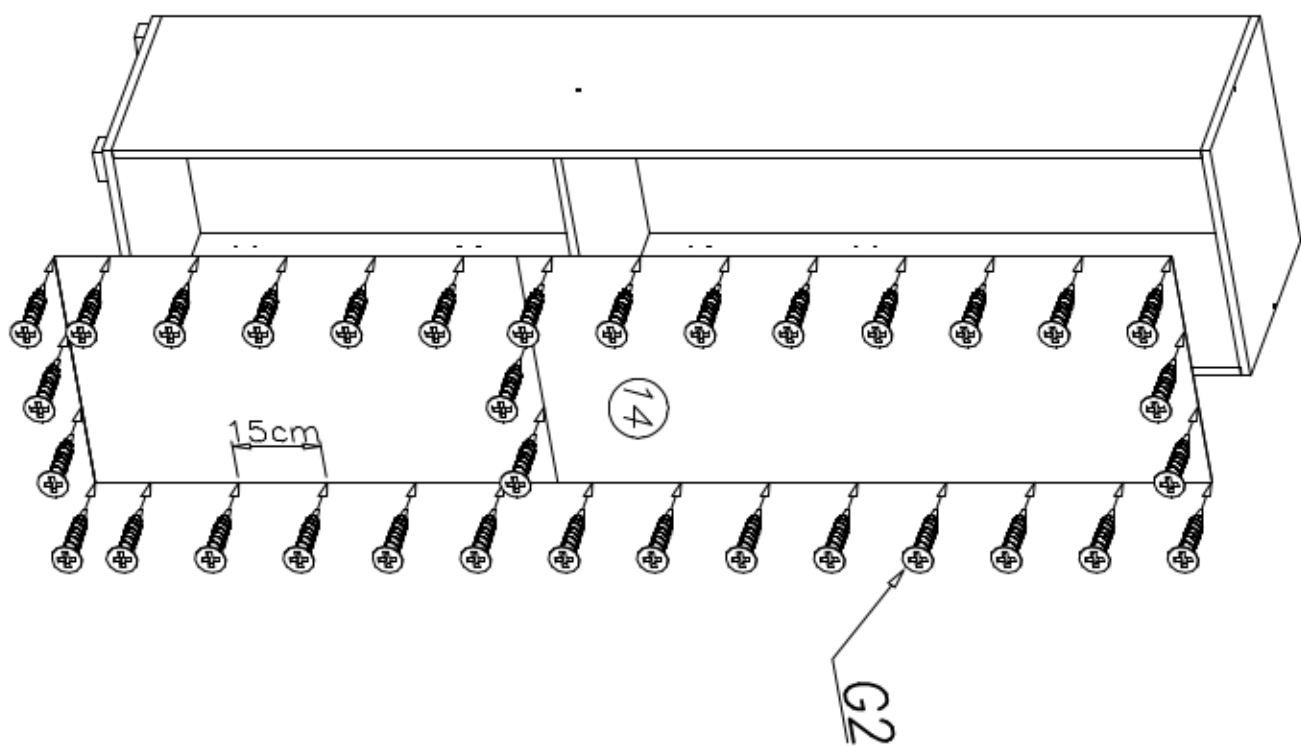

III

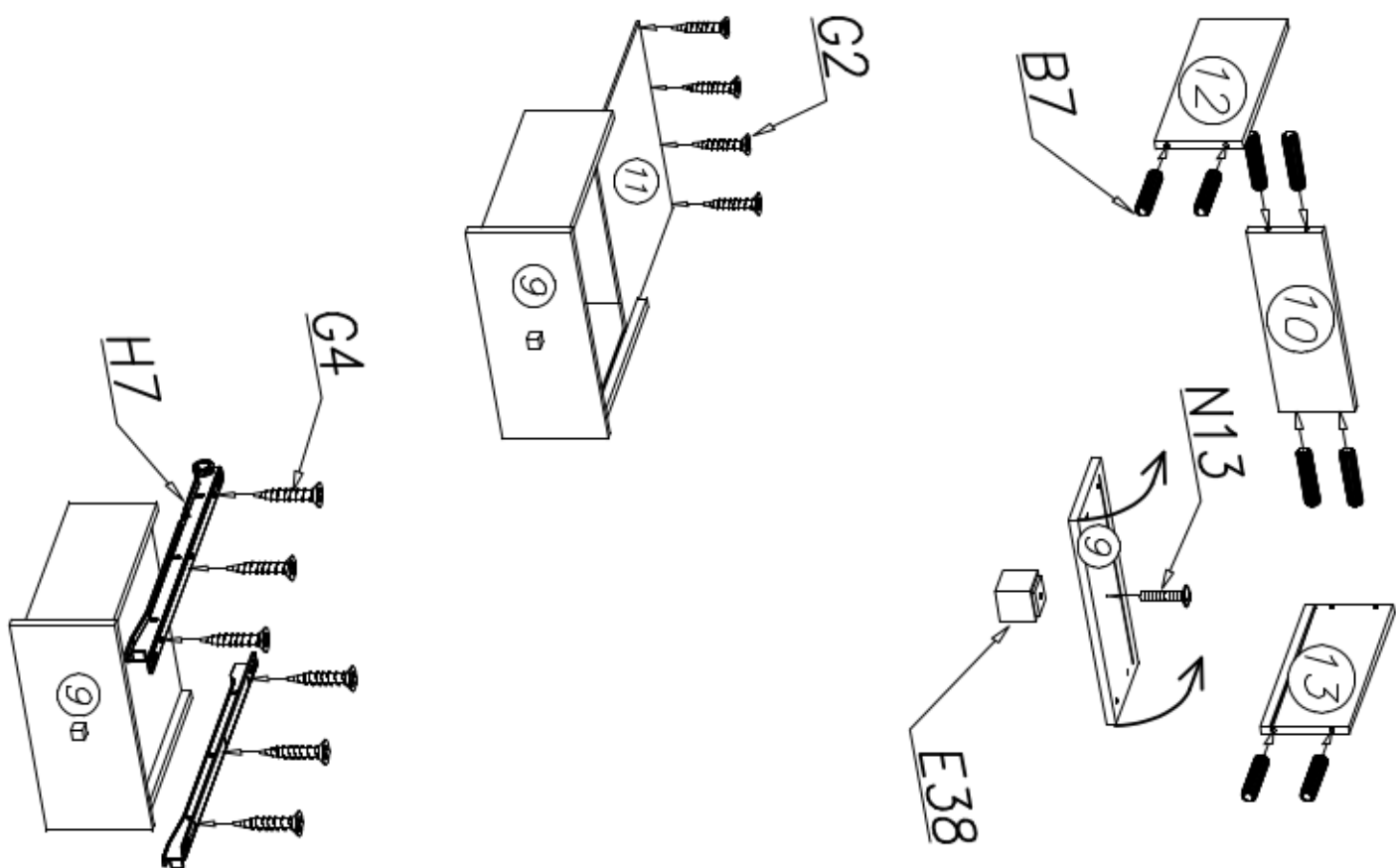

IV

