

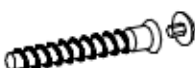

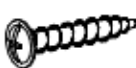



<p>A1  x9 ø7x50</p>	<p>G8  x3 4x30</p>	<p>B2  x6 ø6x30</p>	<p>U4  x2</p>	<p>U12  x2</p>
<p>B7  x13 ø8x30</p>	<p>W2  x1</p>	<p>W1  x1 GLUE, LEIM, LEPIDLO, LIM</p>	<p>G4  x4 4x16</p>	

I

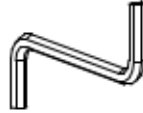

II

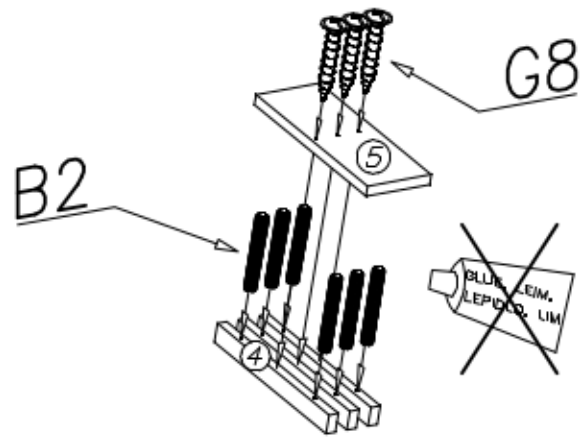
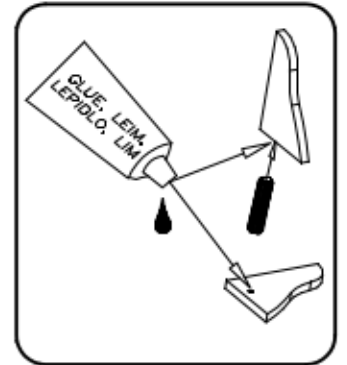
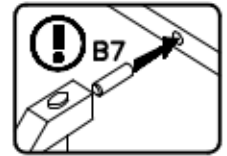
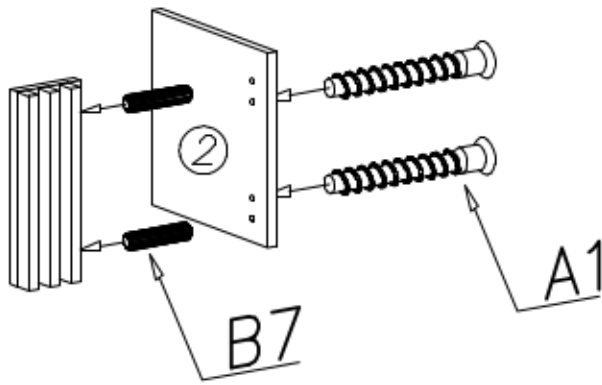

III

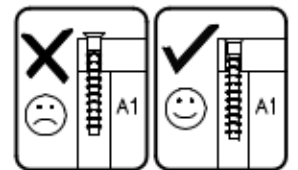
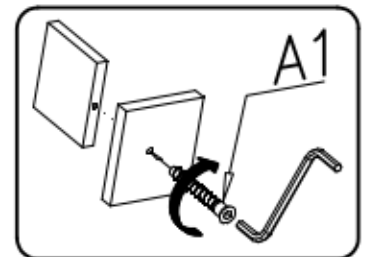
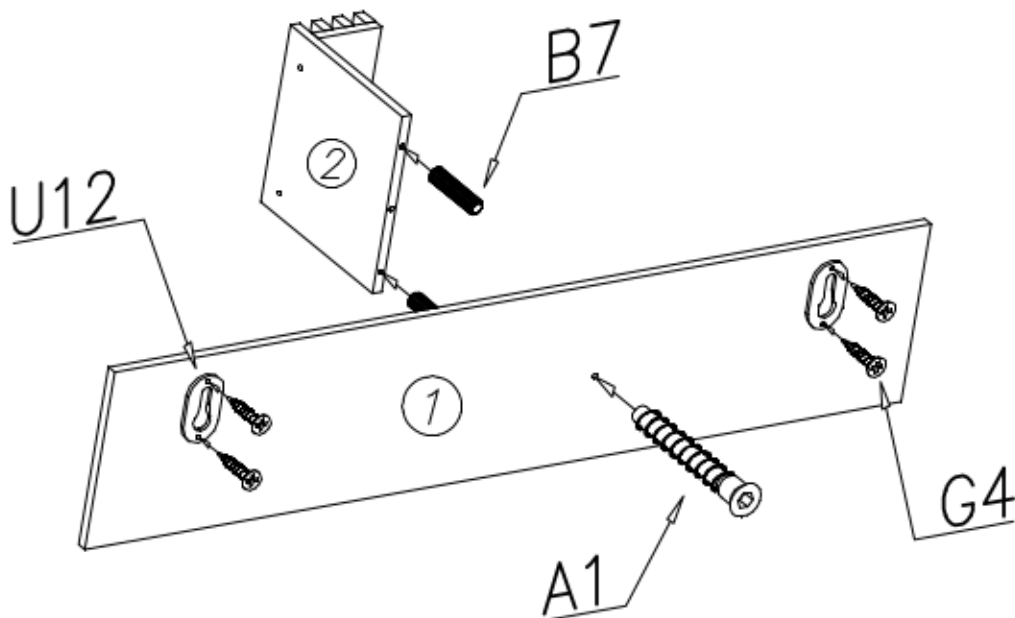

IV

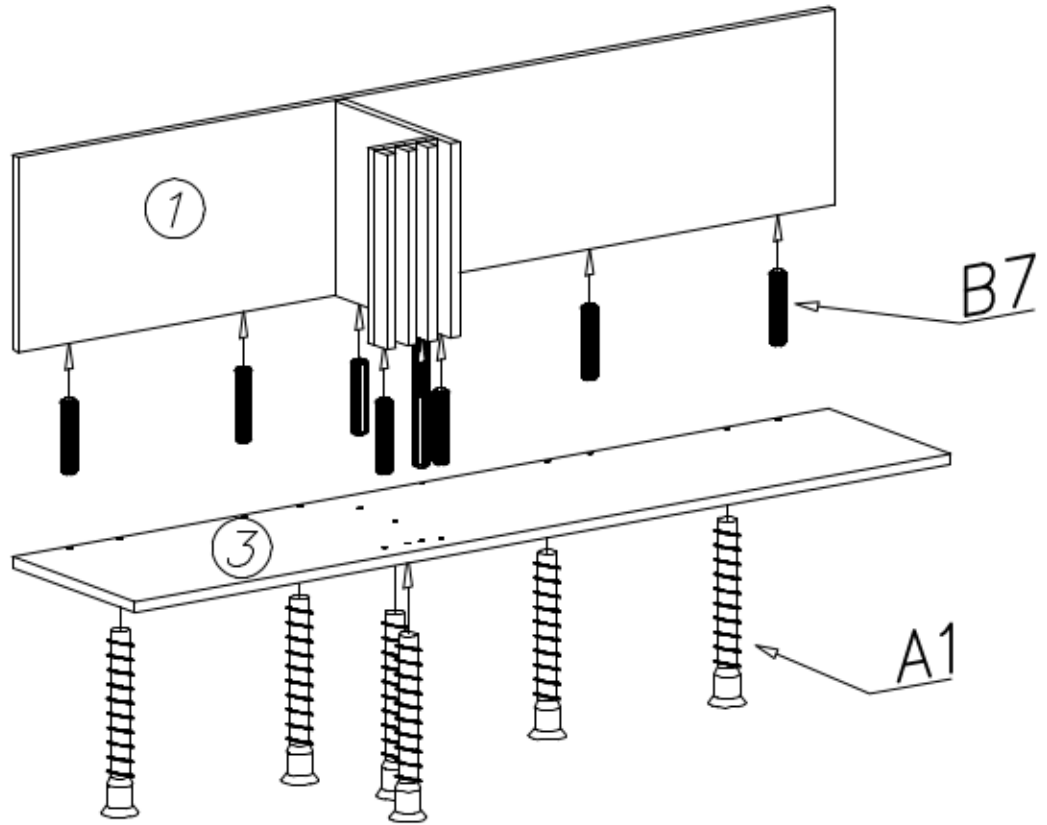
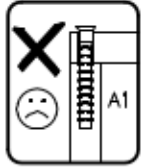
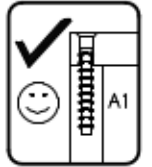
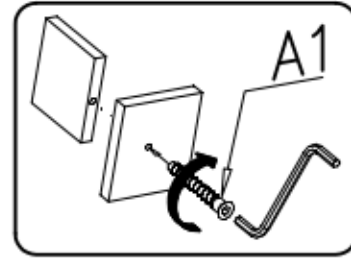
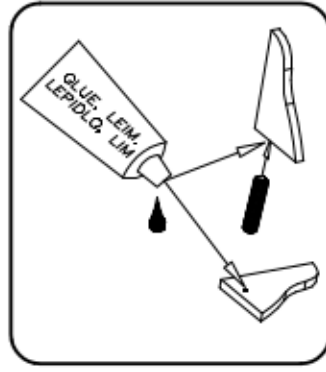
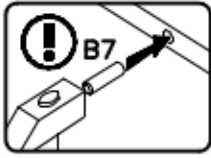

V

