







**B2**  
  
 ø6x30 x24

**N13**  
  
 M4x22 x8

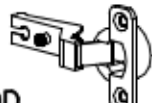
**C4**  
  
 Z350D x6

**D4**  
  
 PZ350D x6

**P3**  
  
 x6

**H25**  
  
 400mm x2

**E11**  
  
 x4

**W1**  
  
 x3

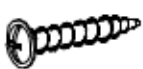
**G8**  
  
 4x30 x16

**S2**  
  
 x12

**S5**  
  
 574mm x1

**G4**  
  
 4x16 x12

**G2**  
  
 3x20 x60

**G6**  
  
 3x13 x2

**G1**  
  
 4x13 x20

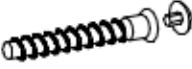
**A1**  
  
 ø7x50 x28

**B7**  
  
 ø8x30 x61

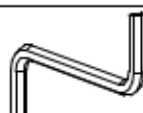
**W2**  
  
 x1

**F1**  
  
 x17

**S4**  
  
 x2

I

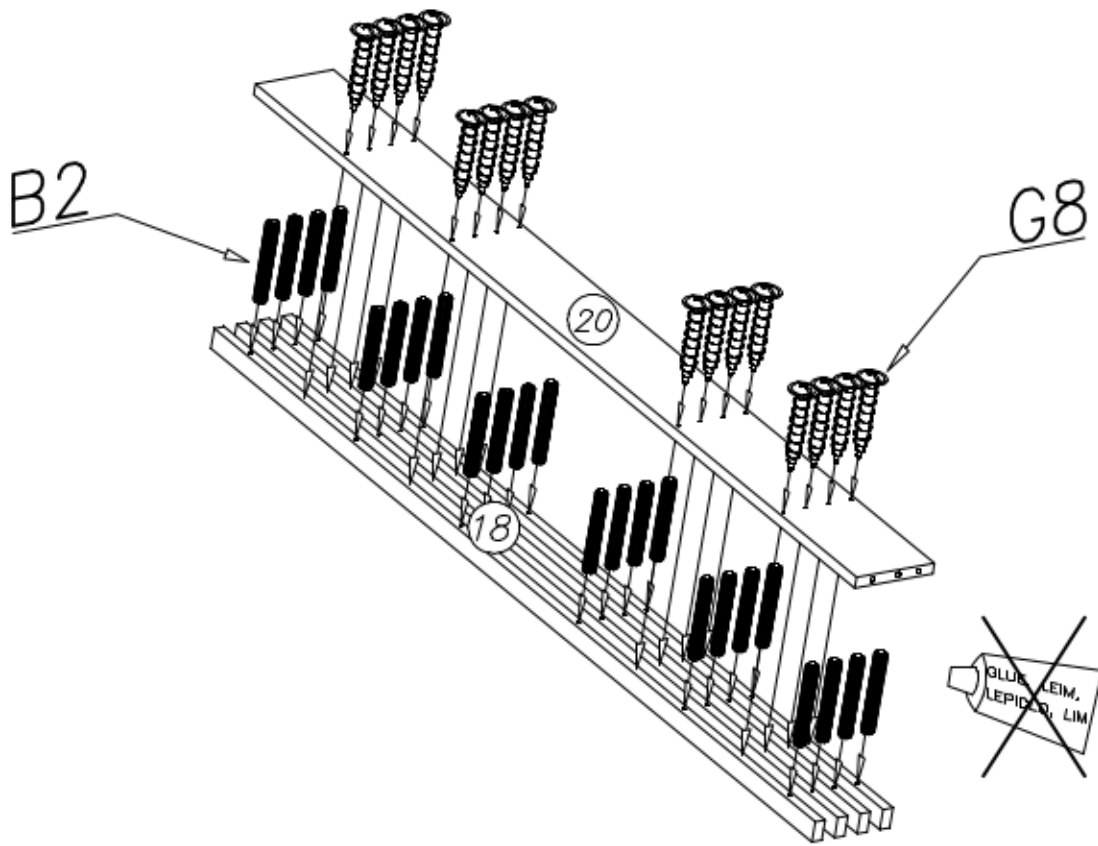

II

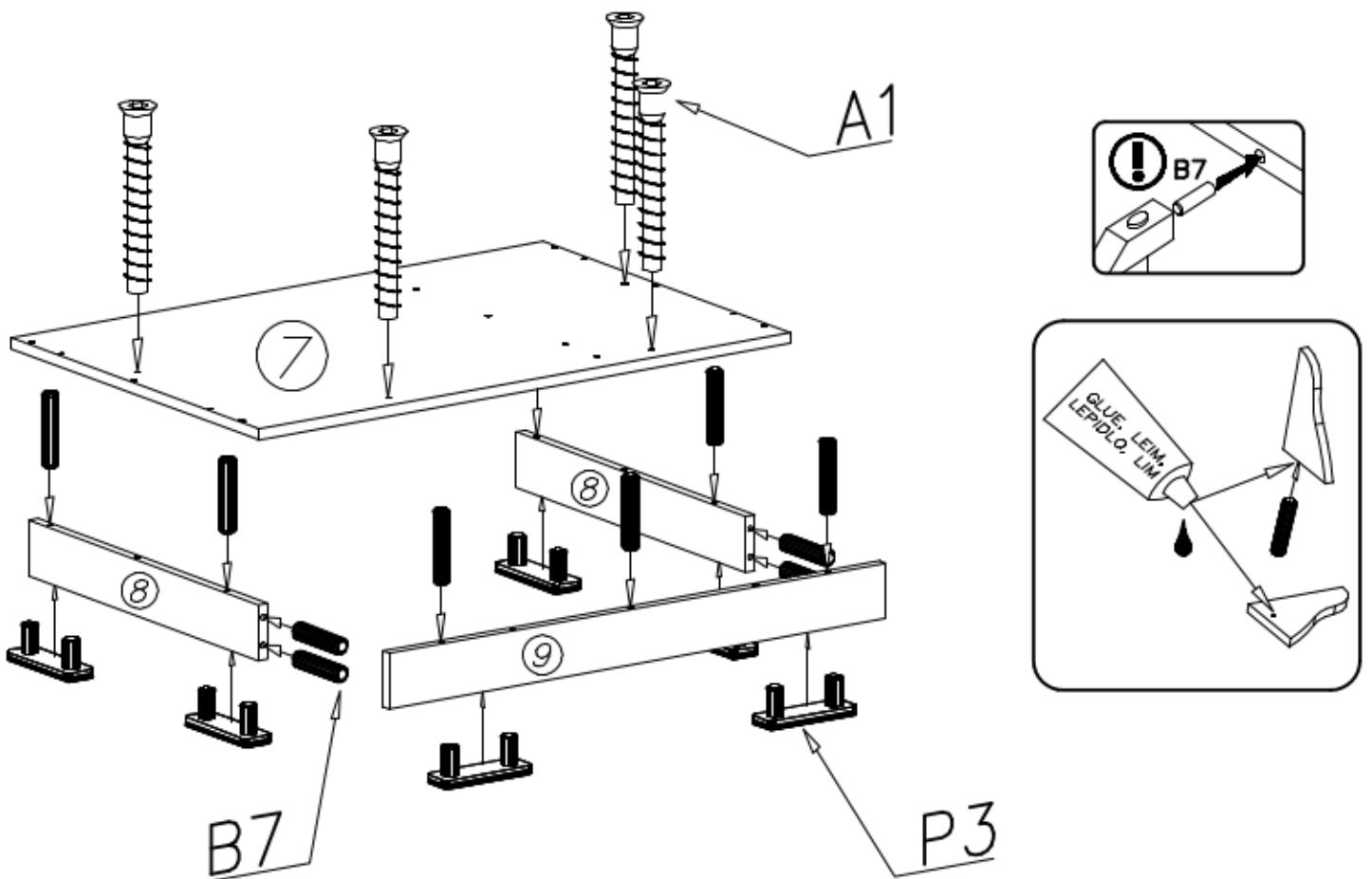

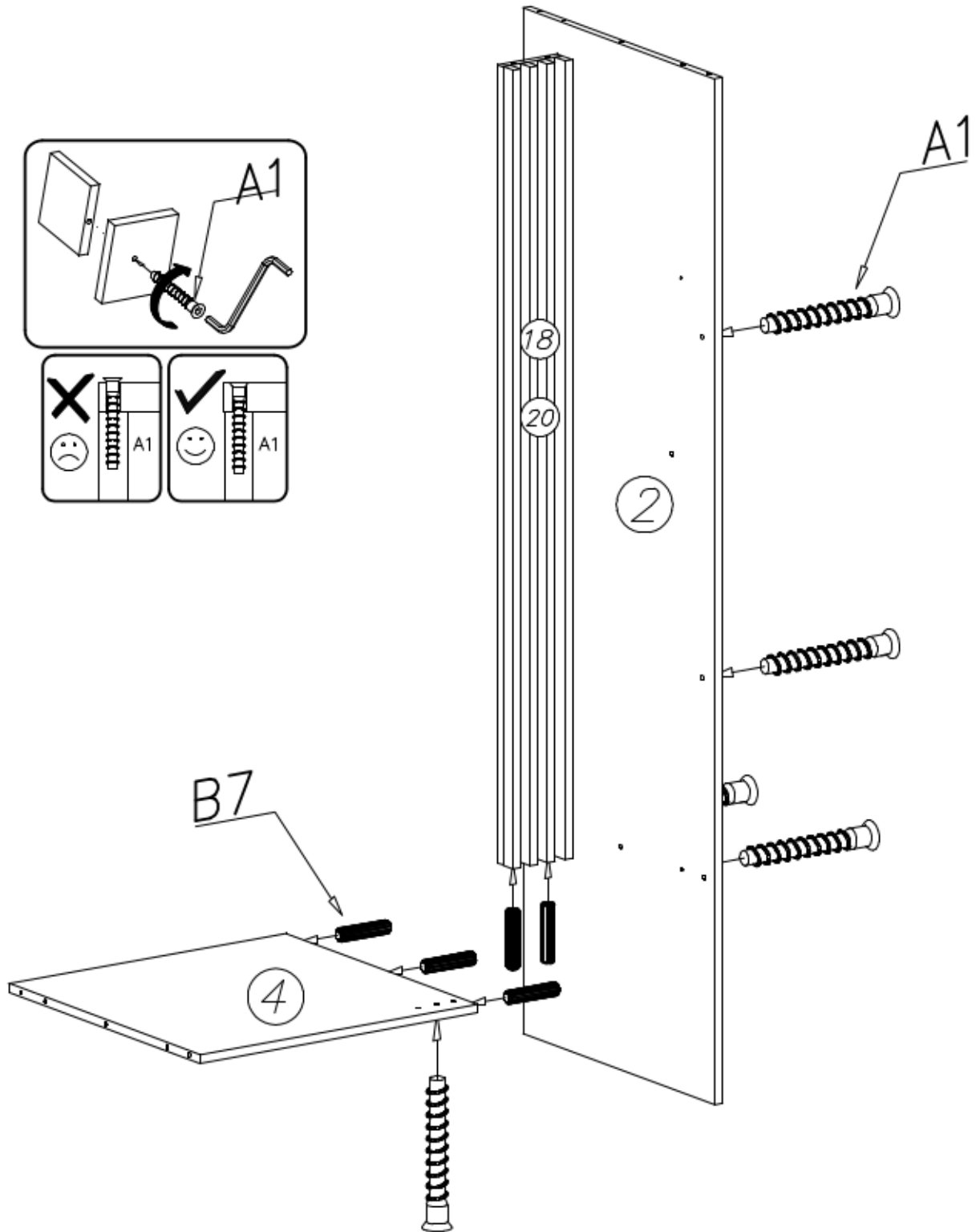
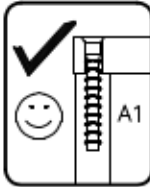
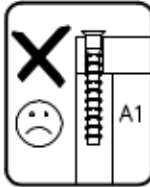
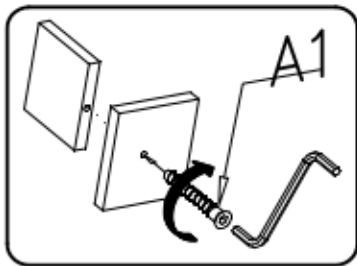
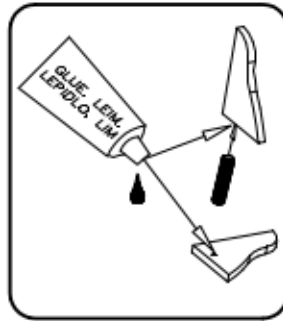
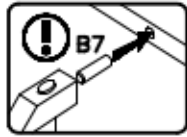

IV

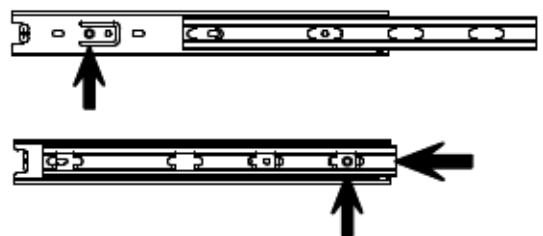
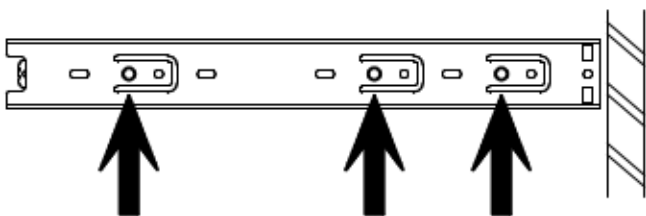
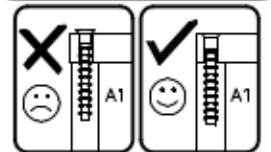
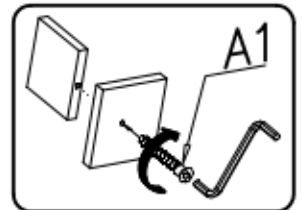
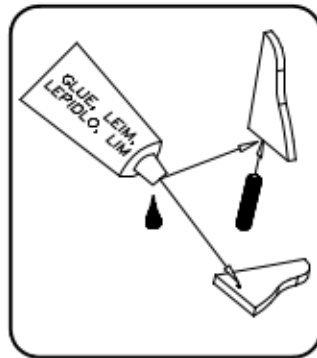
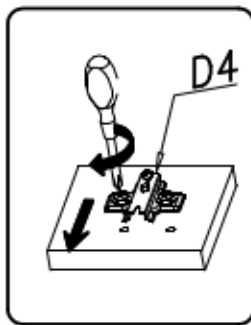
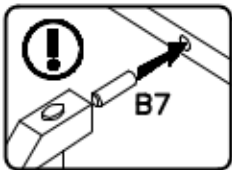
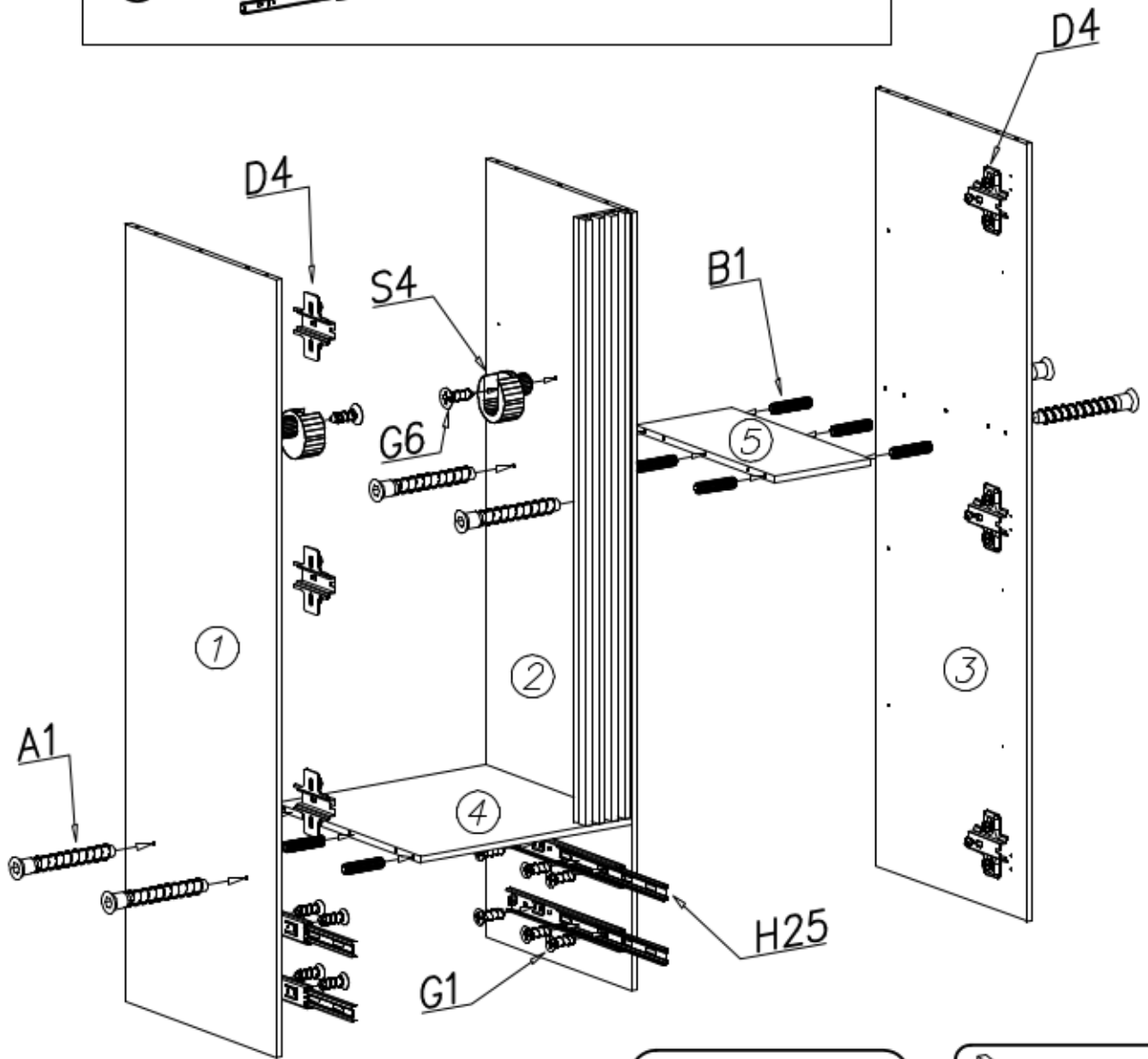
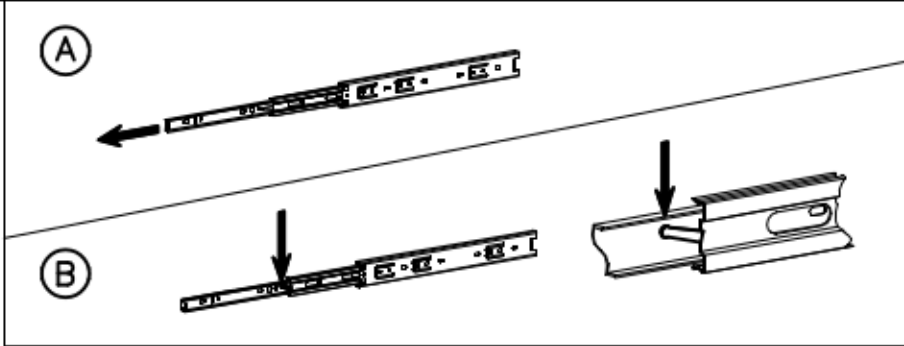

V

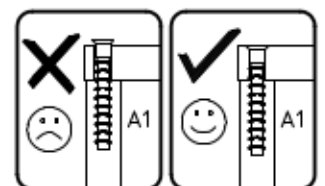
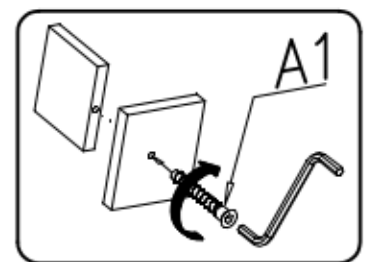
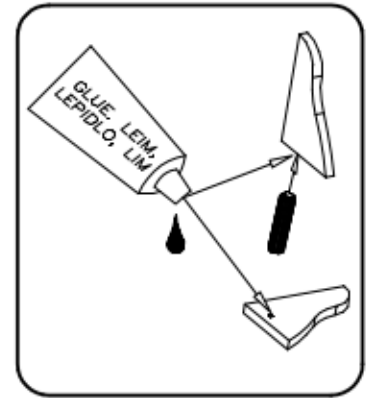
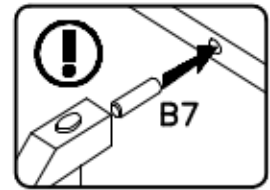
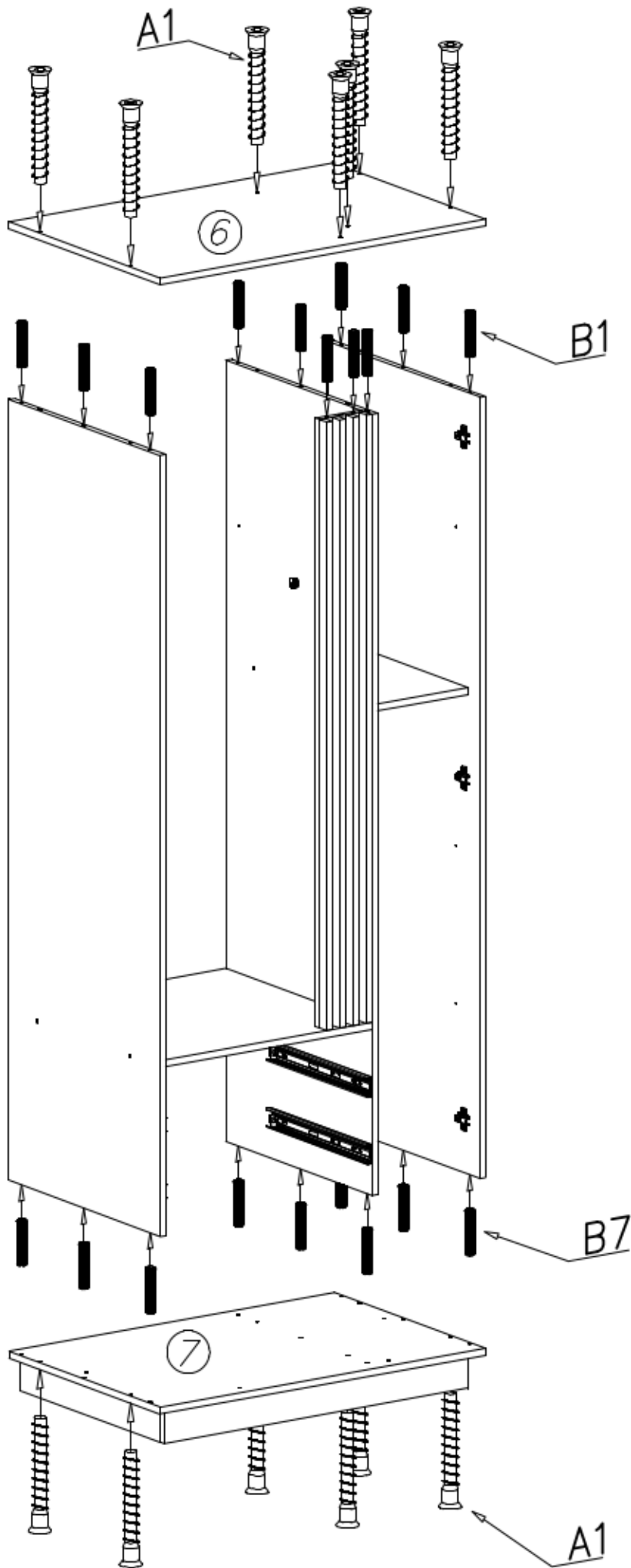

VI

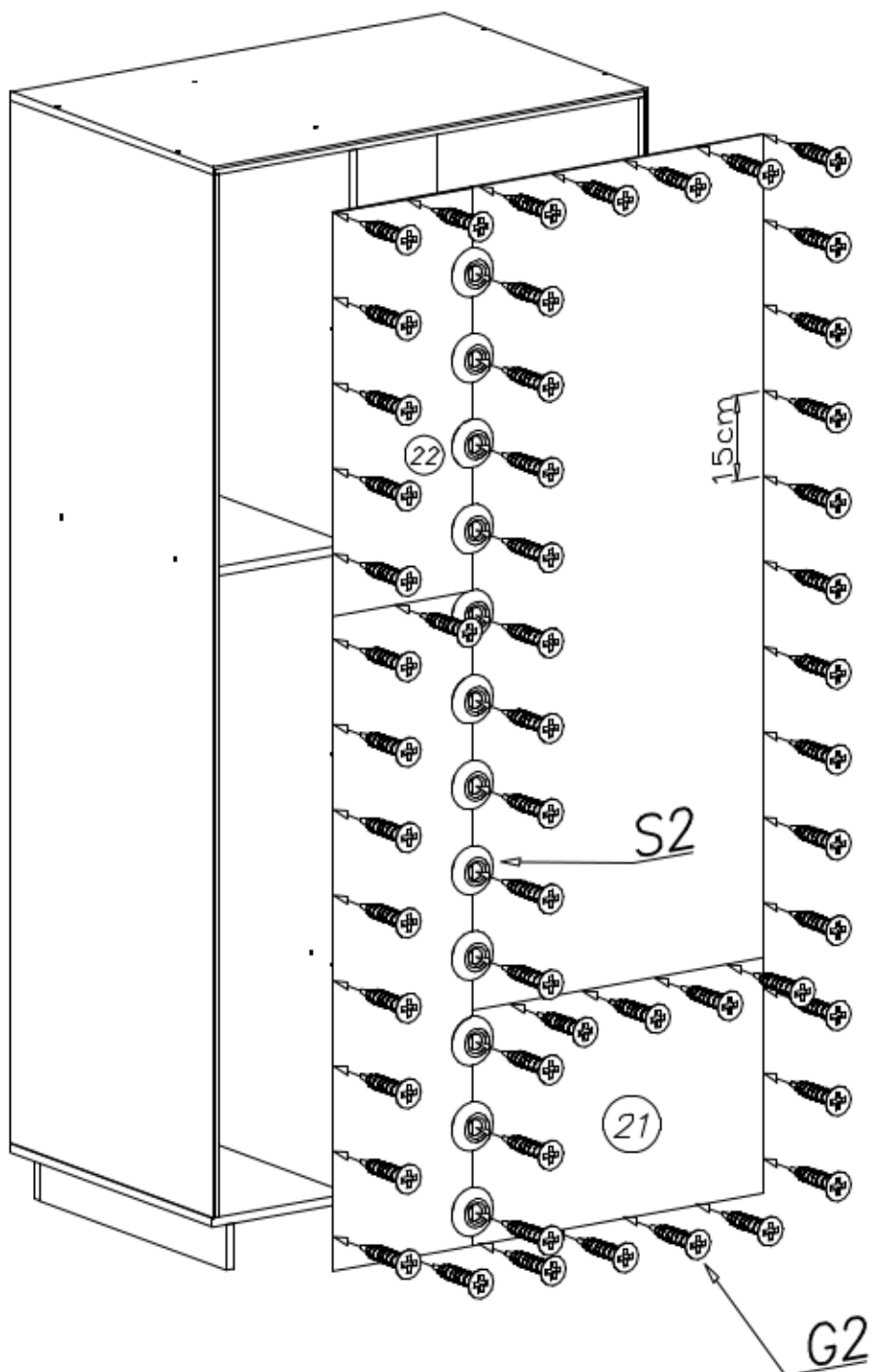
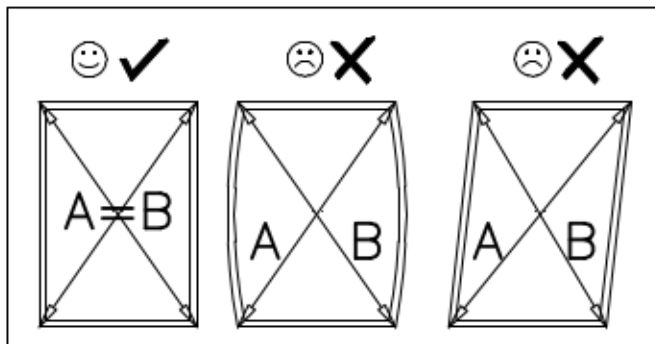

VII

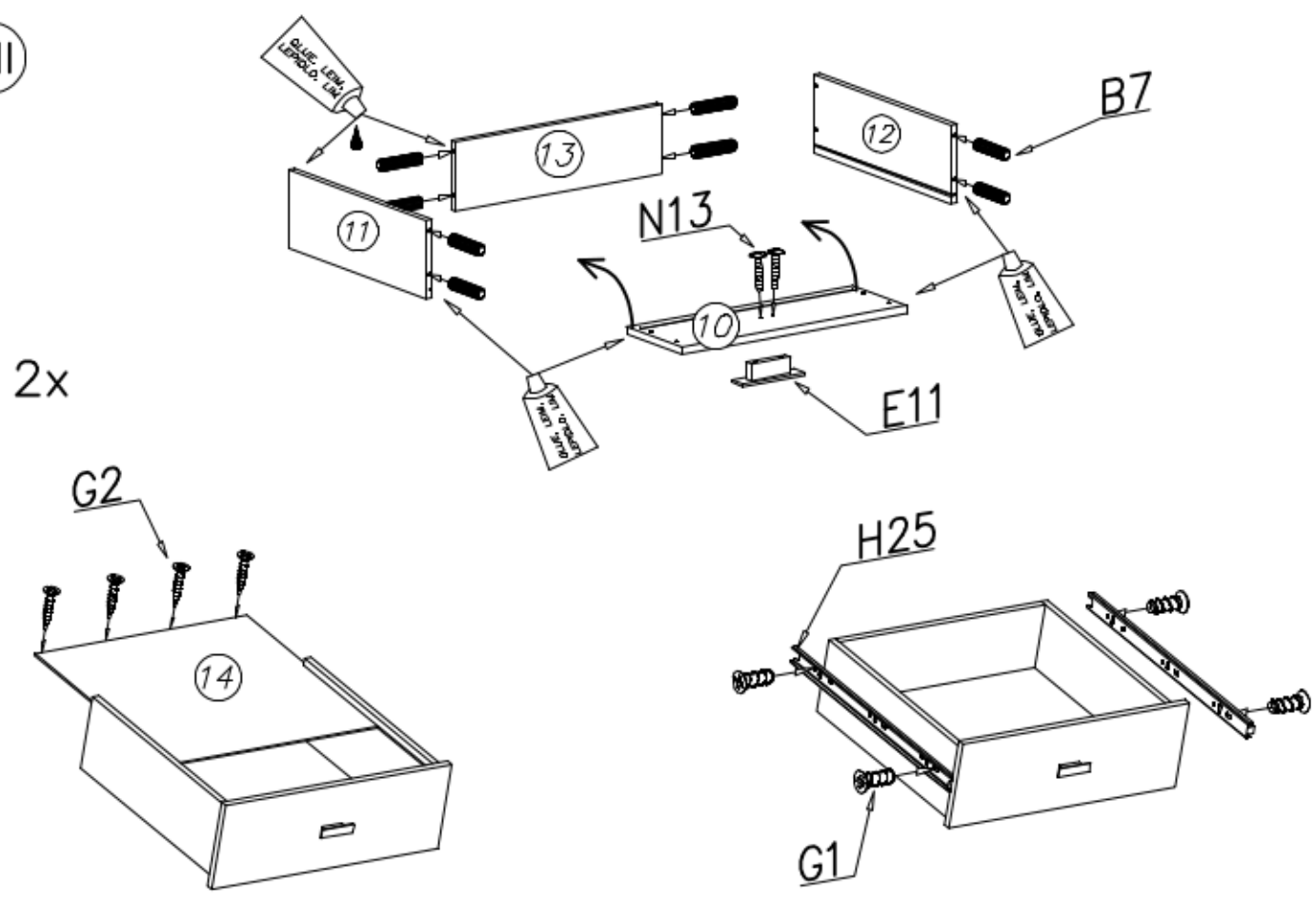

VIII

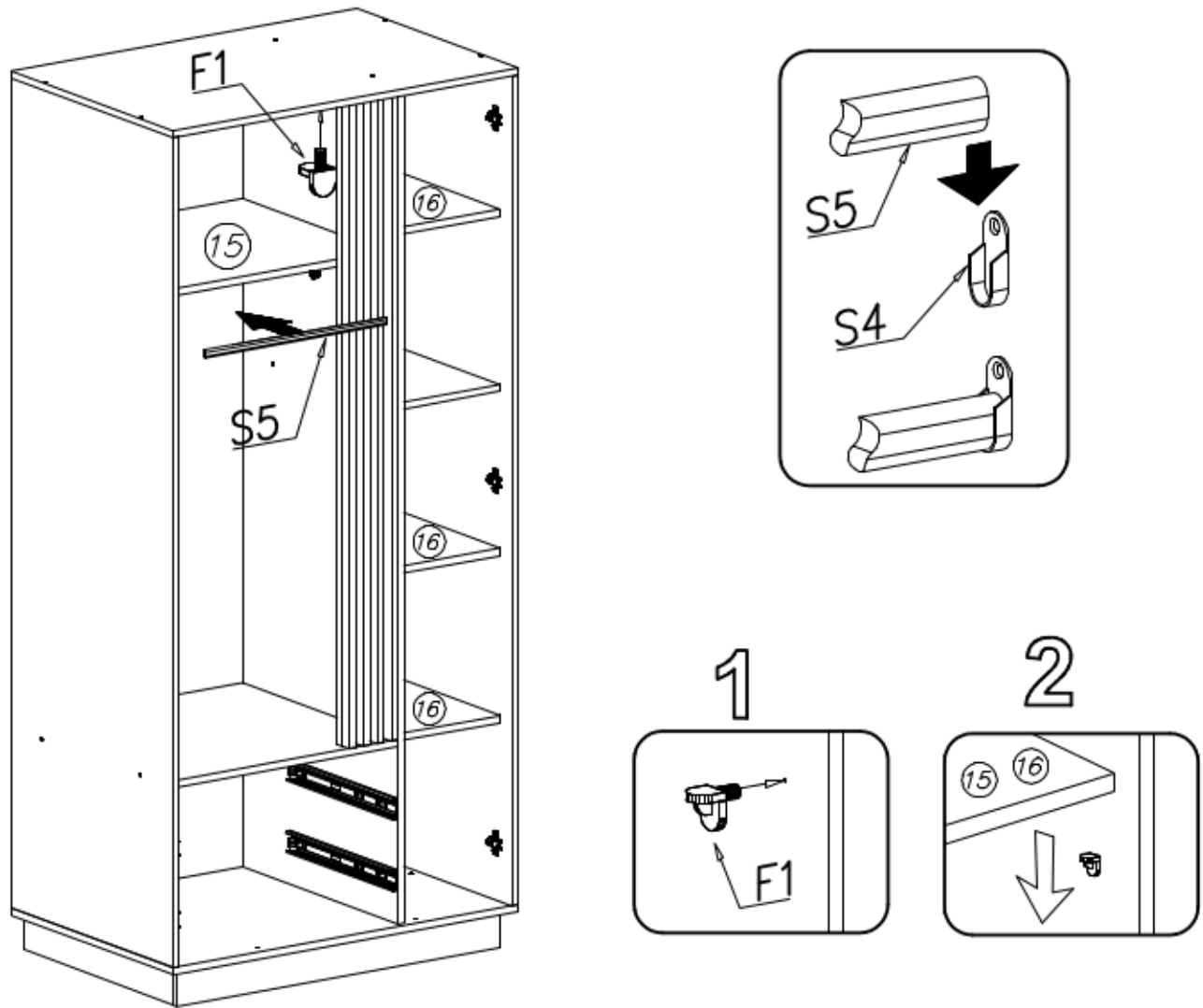

IX

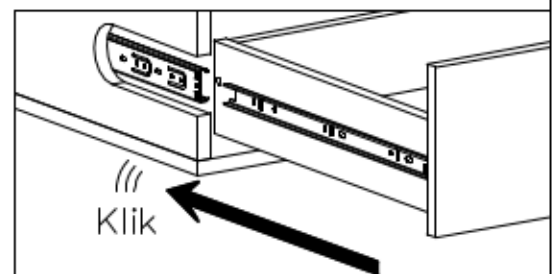
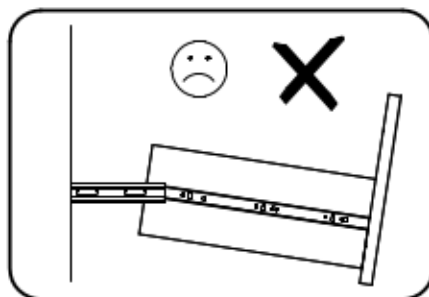
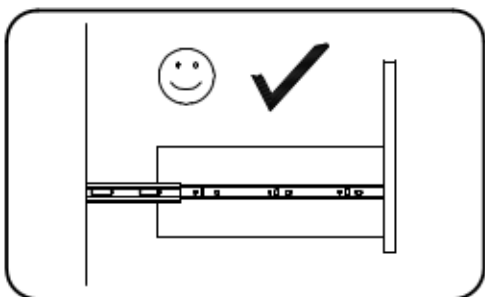
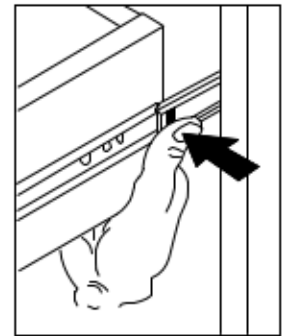
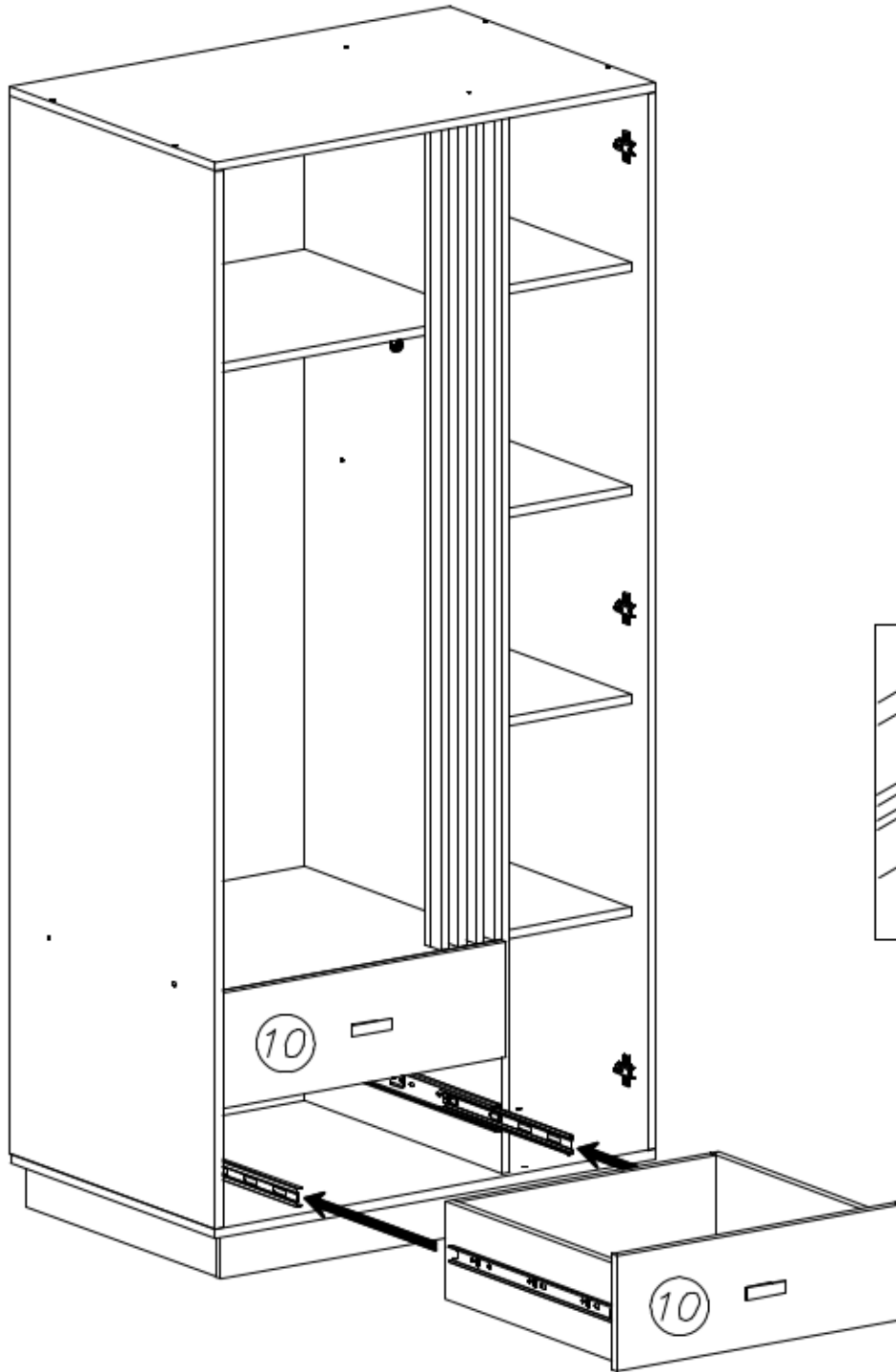



(X)

