

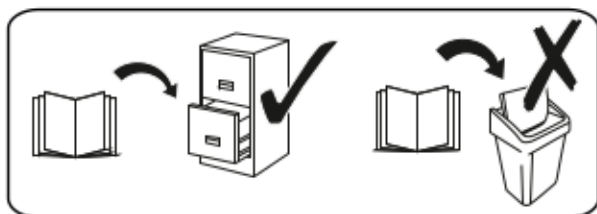

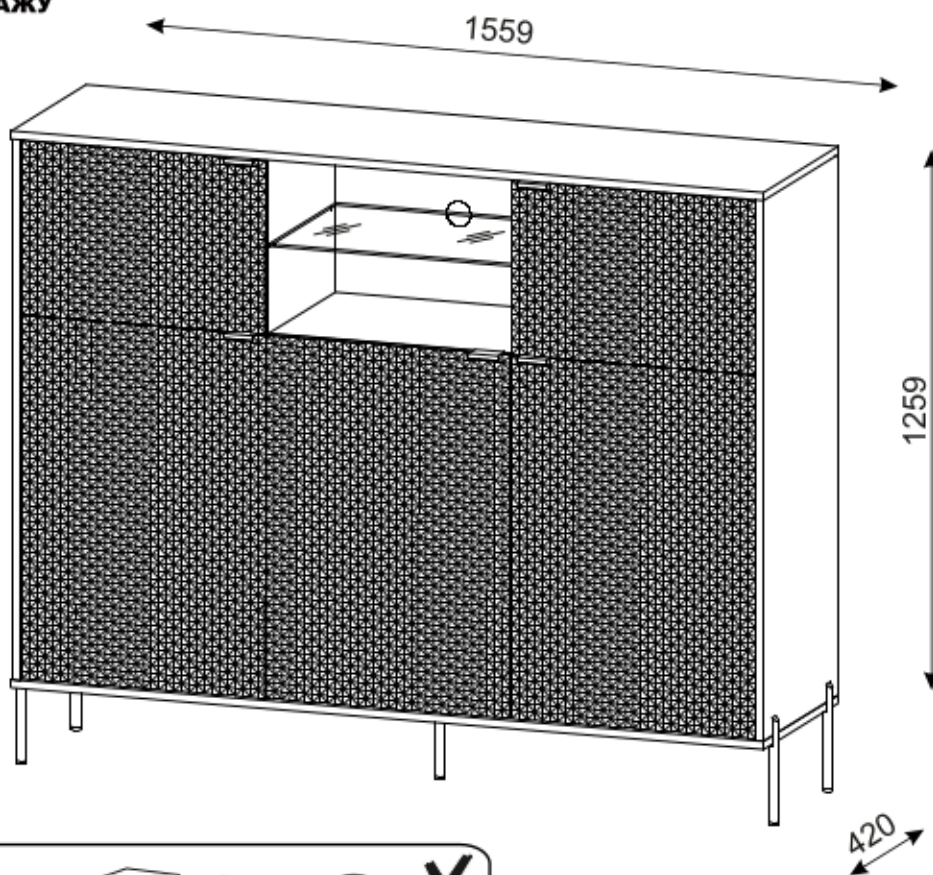

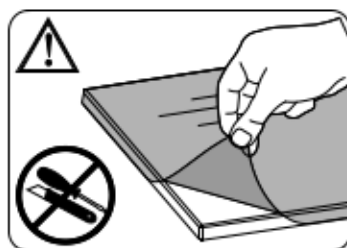

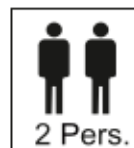

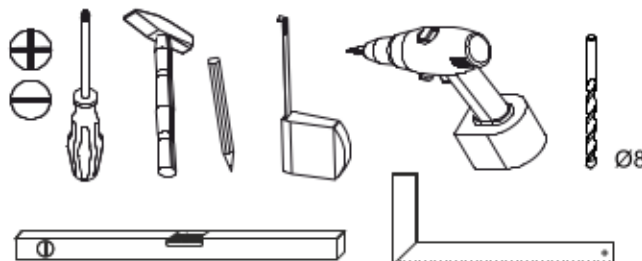















INSTRUKCJA MONTAŻU
ІНСТРУКЦІЯ МОНТАЖУ
ASSEMBLY MANUAL
INSTRUCTIONS POUR LE MONTAGE
MONTAGEANLEITUNG
MONTÁŽNY NÁVOD
NÁVOD NA MONTÁŽ
INSTRUCȚIUNI DE MONTARE
SZERELÉSI ÚTMUTATÓ
UPUTE ZA SASTAVLJANJE
ІНСТРУКЦІЇ ЗА МОНТАЖ
ΟΔΗΓΙΕΣ ΣΥΝΑΡΜΟΛΟΓΗΣΗΣ
NAVODILA ZA MONTAŽO
MONTERINGSANVISNINGAR
INSTRUCCIONES DE MONTAJE
ISTRUZIONI DI MONTAGGIO
УПУТСТВО ЗА МОНТАЖУ



Do montažu potrebne są:
Для монтажу потрібно:
You need for fitting-up:
Pour le montage il faut:
Für Montage werden benötigt:
К монта́ї потрібуюте:
Na montáž potrebujete:
Pentru asamblare aveți nevoie de:
Az összeszereléshez szüksége lesz:
Za montažu vam je potrebno:
За сглобяване са ви необходими:
Για τη συναρμολόγηση χρειάζεστε:
Za montažo potrebujete:
För montering behöver du:
Para realizar el montaje es necesario:
Per il montaggio sono necessari:
За монтажу вам је потребно:



- PL** Powierzchnię mebli należy czyścić tylko środkami do pielęgnacji mebli. Szanowny kliencie w przypadku reklamacji prosimy wypełnić druki reklamacyjne dostępne w punktach sprzedaży przedkładając Kartę Reklamacyjną (zawierającą datę produkcji i numer pakowacza lub zmiany pakowania) umieszczona w każdej z paczek, oraz instrukcję montażu mebla, gdzie prosimy o zaznaczenie uszkodzonego elementu.
- UA** Поверхню меблів треба очистити тільки засобами для догляду за мебелями. Шановний клієнт для заяви рекламації, просимо заповнити формуляр рекламації, доступний у пунктах продажу, вказуючи рекламаційну карту (містить дату виробництва та номер пакувальника або зміни упаковки), прикладену до кожного пакету, а також інструкцію з монтажу меблів, на якій просимо позначити пошкоджений елемент.
- GB** Furniture surface must be cleaned only with furniture maintenance formulas. Dear customer, should you wish to file a complaint, we would request you to fill in the complaint forms available in our outlets, submitting the Complaint Card (specifying the date manufactured, packaging employee/ shift code) enclosed in each of the packets, together with the Assembly Manual, where please highlight the faulty component.
- FR** La surface des meubles ne peut être nettoyée qu'avec des produits pour l'entretien de meubles. Cher Client, en cas de réclamation, veuillez bien remplir des formulaires de réclamation accessibles dans les centres de vente en montrant le mode d'emploi pour monter le meuble. Nous vous demandons de bien vouloir y entourer l'élément en panne.
- DE** Reinigen Sie den Möbelbereich nur mit Möbelpflege. Kunden, bei Beanstandung Bitte füllen Sie die Reklamationsformulare, die in den Verkaufsabteilungen erhältlich sind, vor dem Verkauf aus eine Reklamationskarte (mit Angabe des Produktionsdatums und der Anzahl der Personen, die die Waren verpacken, oder der Anzahl der Schichten) Verpackung), die in jeder Packung enthalten ist, und Halterungen, in denen Sie reichlich vorhanden oder beschädigt sind Elemente Reinigen Sie den Möbelbereich nur mit Möbelpflege. Kunden, bei Beanstandung.
- CZ** Povrch nábytku čistíte pouze přípravky určenými k ošetřování nábytku. Vá ený zákazník, v případě uplatnění reklamace vyplňte prosím reklamační formuláře, které jsou dostupné v prodejnách a předlo te Reklamační kartu (obsahující datum výroby a číslo balení nebo změny balení, která je umístěna v balíčku) a návod k obsluze s vyznačením poškozeného dílu.
- SK** Povrch nábytku čistíte iba prostriedkami určenými na ošetrovanie nábytku. Vá ení zákazníci! V prípade reklamácie prosíme, aby ste vyplnili tlačivá, ktoré sú prístupné v obchodoch, predlo ili Reklamačný list (ktorý obsahuje dátum výroby a číslo balíča alebo číslo zmeny pri balení), ktorý sa nachádza v ka dom balení a návod na montáž nábytku, v ktorom označte poškodenú časť.
- RO** Suprafata ei trebuie să fie curătată numai cu substanțe destinate pentru curățarea mobilei. Stimate Cumpărător, în caz de reclamație vă rugăm să completați formularul de reclamație pe care îl puteți lua de la punctul de vânzare și pe care îl veți prezenta împreună cu Cartela de Garanție (care conține data producției și nr ambalatorului sau turei de ambalare), însoțită la ficare ambalaj, precum și instrucțiunile de montaj ale mobilei, pe care vă rugăm să marcați elementul deteriorat.
- HU** A bútor felületét csak bútorápoló szerekkel szabad tisztítani. Tisztelt Ügyfelünk, panaszával! Kérjük, töltsse ki az értékesítési pontokon elérhető reklamációs űrlapot a panaszkártya megjelölésével (a dátumot tartalmazza a csomagoló gyártása és száma vagy a csomagcsere) minden csomaghoz mellékelve, valamint a beszerelési útmutatóbútor, amelyen kérjük a sérült elem megjelölését.
- HR** Površinu namještaja treba čistiti samo sredstvima za njegu namještaja. Poštovani kupci za reklamaciju, ispunite obrazac za reklamacije dostupan na prodajnim mjestima uz naznaku reklamacijske kartice (sadrži datum proizvodnja i broj pakera ili promjena paketa) priložen uz svaki paket, kao i upute za montažunamještaja, na kojem Vas molimo da označite oštećeni element.
- BG** Повърхността на мебелите трябва да се почиства само с препарати за поддържане на мебели. Уважаеми клиенти, в случай на reclamaция моля попълнете формулярите за reclamaция, които ще получите в търговските пунктове, като представите Картата за reclamaция (съдържаща датата на производство и номера на опаковчика или смяната за опаковане), която ще намерите във всяка опаковка, и инструкцията за монтаж на мебела, върху която да отбележите повредения елемент.
- GR** Η επιφάνεια των επίπλων πρέπει να καθαρίζεται μόνο με προϊόντα περιποίησης επίπλων. Αγαπητέ πελάτη, για να κάνετε ένα παράπονο, συμπληρώστε τη φόρμα παραπόνων που είναι διαθέσιμη στα σημεία πώλησης, αναφέροντας την κάρτα παραπόνων (που περιέχει την ημερομηνία κατασκευής και τον αριθμό του συσκευαστή ή αλλαγής συσκευασίας) που επισυνάπτεται σε κάθε συσκευασία, καθώς και τις οδηγίες συναρμολόγησης επίπλων, στις οποίες σας ζητάμε να σημειώσετε το κατεστραμμένο αντικείμενο.
- SI** Površino pohištva čistite samo s sredstvi za nego pohištva. Spoštovani kupec, prosimo, da za reklamacijo izpolnite reklamacijski obrazec, ki je na voljo na prodajnih mestih, in navedite reklamacijski karton (z datumom izdelave in številko embalaže ali spremembe embalaže), ki je priložen vsakemu paketu ter navodila za montažo pohištva, na katerih vas prosimo, da označite poškodovani artikel.
- SE** Ytan på möbeln ska endast rengöras med möbelsvårdsprodukter. Bästa kund, för att göra ett klagomål, vänligen fyll i reklameringsformuläret som finns på försäljningsställena, med angivande av reklameringskortet (som innehåller tillverkningsdatum och numret på förpackaren eller bytet av förpackning) som bifogas varje förpackning, samt möbemonteringsanvisningen, på vilken vi ber dig att märka den skadade varan.
- ES** Limpiar la superficie de muebles exclusivamente con los agentes para el cuidado de los muebles. Estimado Cliente, en caso de reclamaciones, hagan favor de rellenar los formularios de reclamación disponibles en los puntos de venta, presentando las instrucciones de montaje de mueble, donde es necesario indicar un elemento estropeado.
- IT** La superficie dei mobili deve essere pulita solo con prodotti per la cura dei mobili. Gentile cliente, per presentare un reclamo, La preghiamo di compilare il modulo di reclamo disponibile presso i punti vendita, indicando la scheda di reclamo (contenente la data di produzione e il numero dell'imballatore o del cambio di imballo) allegata a ciascun pacco, nonché le istruzioni di montaggio del mobile, sulle quali vi chiediamo di contrassegnare l'oggetto danneggiato.
- RS** Površinu namештаја треба čistiti samo sredstvima za negu namештаја. Poštovani kupce, za reklamaciju popunite formular za reklamaciju koji je dostupan na prodajnim mestima, navodeći reklamaciju (koja sadrži datum proizvodnje i broj pakera ili promene pakovanja) priloženu uz svako pakovanje, kao i uputstvo za montažu namештаја, na koje vas molimo da obeležite oštećeni predmet.

A0  Ø8x30 x20	A1  Ø8x50 x4	B1  Ø7x50 x8	B3  Ø5 x4	B4  x4	C2  x12	C4  x20	C6  84 mm x4	C7  16 mm x20	D0  3x15 x38	D4  3.5x16 x20
D5  3.5x16 x24	E0  8x50 x2	G14  x1	G16  x1	J5  x10	K  4mm x1	L0  x5	M1 x20	M3  x8	P0  x2	Q1  x4
Q3  x12	T16  x4	T17  x1								

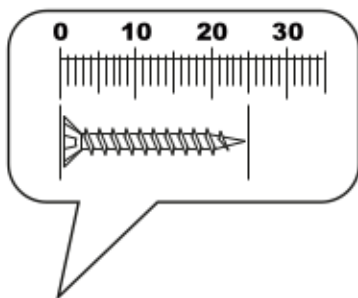

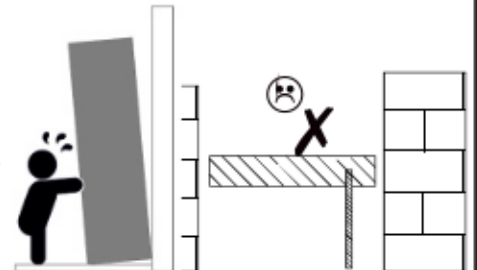
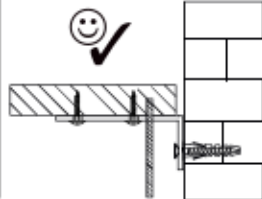
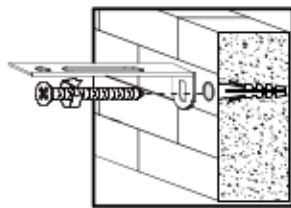

PL Przymocować do ściany
UA Прикріпити до стіни
GB Attach to the wall
FR Fixation au mur
DE An der Wand befestigen
CZ Připevnění ke stěně

SK Pripevnenie na stenu
RO Ataşați la perete
HU A falhoz rögzítés
HR Montaža na zid
BG Закрепване към стената
GR Στερεώστε στον τοίχο

SI Pritrdite na steno
SE Fäst på väggen
ES Fijar a la pared
IT Attacca al muro
RS Причврстите на зид

PL - Proszę nie montować mebla, jeśli jego elementy są uszkodzone. Przed zmontowaniem poszczególne elementy mebla należy dokładnie obejrzeć. W przypadku uszkodzeń, należy je zgłosić wraz z dokumentacją zdjęciową, celem rozpatrzenia reklamacji i podjęcia właściwych działań.

UA - Будь ласка не збирайте меблі, якщо їх елементи пошкоджені. Перед складанням необхідно ретельно оглянути окремі елементи меблів. У разі пошкодження їх, слід повідомити разом з фотодокументацією, щоб розглянути скаргу та вжити відповідних заходів.

GB - Please do not assemble the furniture if its parts are damaged. Before assembling, individual elements of the furniture should be carefully inspected. In case of visible damage, it should be reported along with photographic documentation, to analyse the complaint and take appropriate action.

FR - Si vous constatez que les pièces sont endommagées, veuillez ne pas monter le meuble. Avant le montage, les éléments individuels du mobilier doivent être soigneusement inspectés. En cas d'un endommagement, ils doivent être signalés avec la documentation photographique afin d'examiner la réclamation et de prendre les mesures appropriées.

DE - Bitte montieren Sie die Möbel nicht, wenn ihre Teile beschädigt sind. Vor dem Zusammenbau sollten einzelne Elemente der Möbel sorgfältig geprüft werden. Im Schadensfall sollten sie zusammen mit der Foto Dokumentation gemeldet werden, um die Beschwerde zu prüfen und geeignete Maßnahmen zu ergreifen.

CZ - Prosim, nesebírejte nábytek, pokud jsou jeho prvky poškozené. Před montáží je nutné pečlivě prohlédnout jednotlivé prvky nábytku. V případě jejich poškození je třeba je nahlásit spolu s fotodokumentací pro posouzení reklamace a přijetí vhodných opatření.

SK - Prosim, nezbierajte nábytok, ak sú jeho prvky poškodené. Pred montážou je potrebné dôkladne prezrieť jednotlivé prvky nábytku. V prípade ich poškodenia je potrebné nahlásiť ich spolu s fotodokumentáciou pre posúdenie reklamácie a prijatie vhodných opatrení.

RO - Vă rugăm să nu colectați mobilier dacă elementele acestuia sunt deteriorate. Înainte de asamblare, este necesar să inspectați cu atenție elementele individuale ale mobilierului. În caz de deteriorare a acestora, trebuie raportat împreună cu documentația foto pentru a lua în considerare reclamația și a lua măsurile corespunzătoare.

HU - Kérjük, ne gyűjtse össze a bútorkat, ha azok elemei sérültek. Összeszerelés előtt alaposan meg kell vizsgálni a bútor egyes elemeit. Ha megsérülnek, fényképes dokumentációval együtt be kell jelenteni a panasz mérlegelésére és a megfelelő intézkedések megtételére.

HR - Molimo nemojte skupljati namještaj ako su njegovi dijelovi oštećeni. Prije montaže potrebno je pažljivo pregledati pojedine elemente namještaja. U slučaju oštećenja iste potrebno je prijaviti uz fotodokumentaciju kako bi se reklamacija razmotrila i poduzela odgovarajuće mjere.

BG - Моля, не събирайте мебели, ако елементите им са повредени. Преди сглобяването е необходимо внимателно да се огледат отделните елементи на мебелите. В случай на повреда по тях, тя следва да бъде докладвана заедно със снимков документ за разглеждане на рекламацията и предприемане на съответните мерки.

GR - Μην συλλέγετε έπιπλα εάν τα στοιχεία τους είναι κατεστραμμένα. Πριν από τη συναρμολόγηση, είναι απαραίτητο να επιθεωρήσετε προσεκτικά τα μεμονωμένα στοιχεία των επίπλων. Σε περίπτωση βλάβης τους, θα πρέπει να αναφέρεται μαζί με φωτογραφική τεκμηρίωση για εξέταση της καταγγελίας και λήψη των κατάλληλων μέτρων.

SI - Ne zbirajte pohištva, če so njegovi elementi poškodovani. Pred montažo je potrebno natančno pregledati posamezne elemente pohištva. V primeru poškodb le-teh je potrebno prijaviti skupaj s fotodokumentacijo, da se reklamacija obravnava in ustrezno ukrepa.

SE - Samla inte möbler om dess delar är skadade. Före montering är det nödvändigt att noggrant inspektera de enskilda delarna av möblerna. I händelse av skada på dem bör det rapporteras tillsammans med bildokumentation för att överväga klagomålet och vidta lämpliga åtgärder.

ES - Por favor, no recoja muebles si sus elementos están dañados. Antes del montaje, es necesario inspeccionar cuidadosamente los elementos individuales de los muebles. En caso de daño a los mismos, se debe informar junto con documentación fotográfica para considerar la denuncia y tomar las medidas correspondientes.

IT - Si prega di non raccogliere mobili se i suoi elementi sono danneggiati. Prima del montaggio è necessario ispezionare attentamente i singoli elementi del mobile. In caso di danneggiamento degli stessi, deve essere segnalato insieme alla documentazione fotografica per prendere in considerazione il reclamo e prendere le misure appropriate.

RS - Nemojte sakupljati namještaj ako su njegovi elementi oštećeni. Pre montaže, potrebno je pažljivo pregledati pojedinačne elemente namještaja. U slučaju oštećenja na njima, treba ih prijaviti uz foto dokumentaciju da se reklamacija razmotri i preduzmu odgovarajuće mere.

1

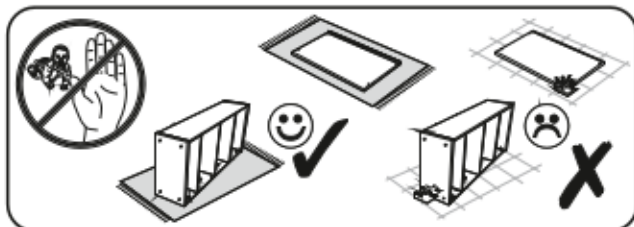

A0 Ø8x30 x8	C2 16 mm x12	C7 16 mm x16	J5 x8	Q3 x4
-------------------------------------	--------------------------------------	--------------------------------------	----------------------------	----------------------------

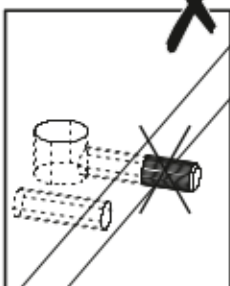
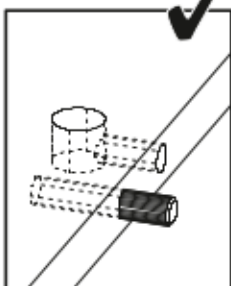
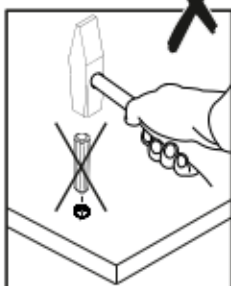
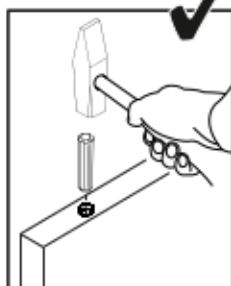
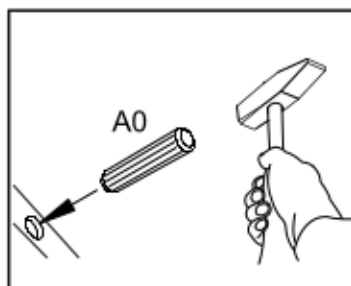
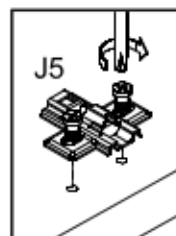
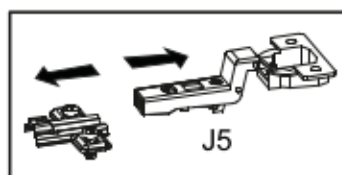
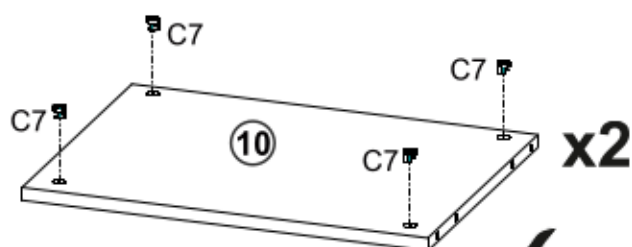
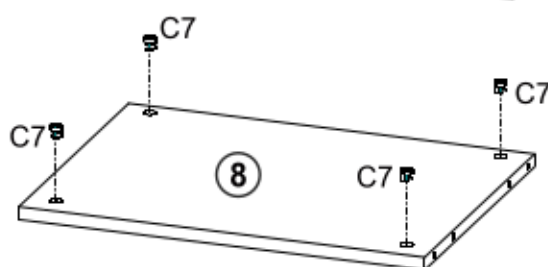
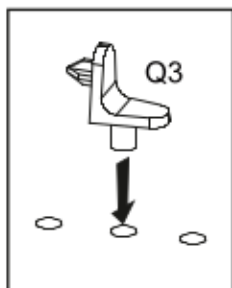
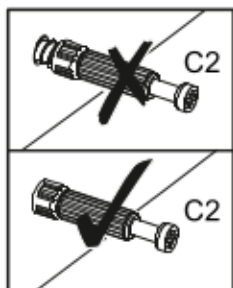
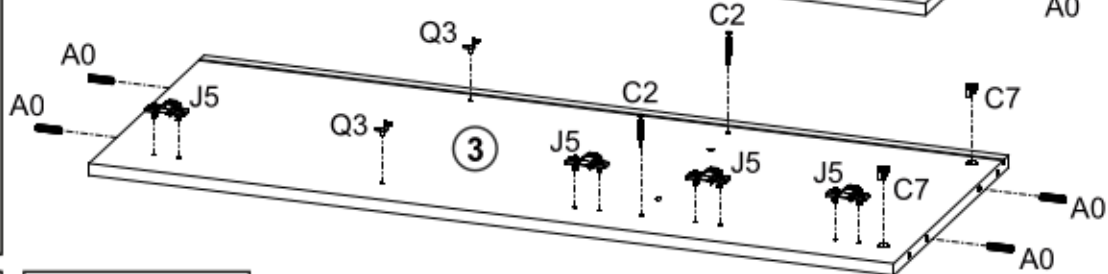
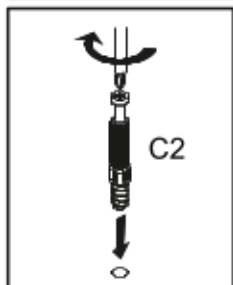
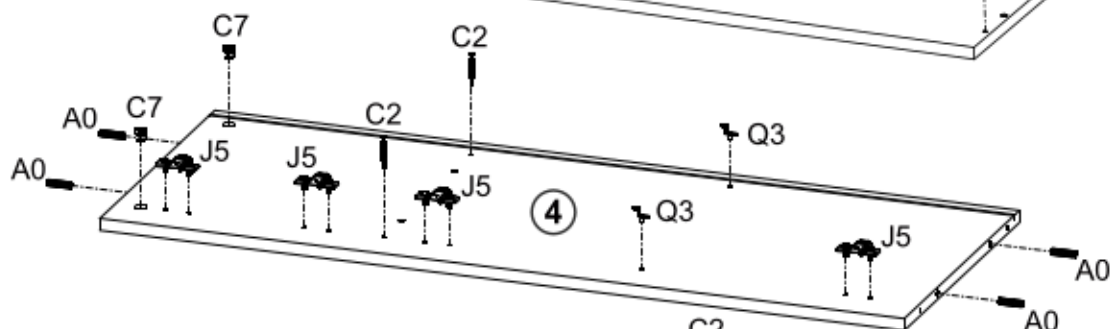
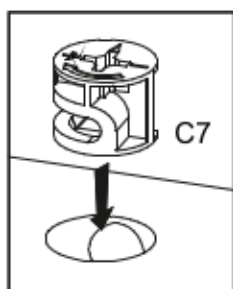
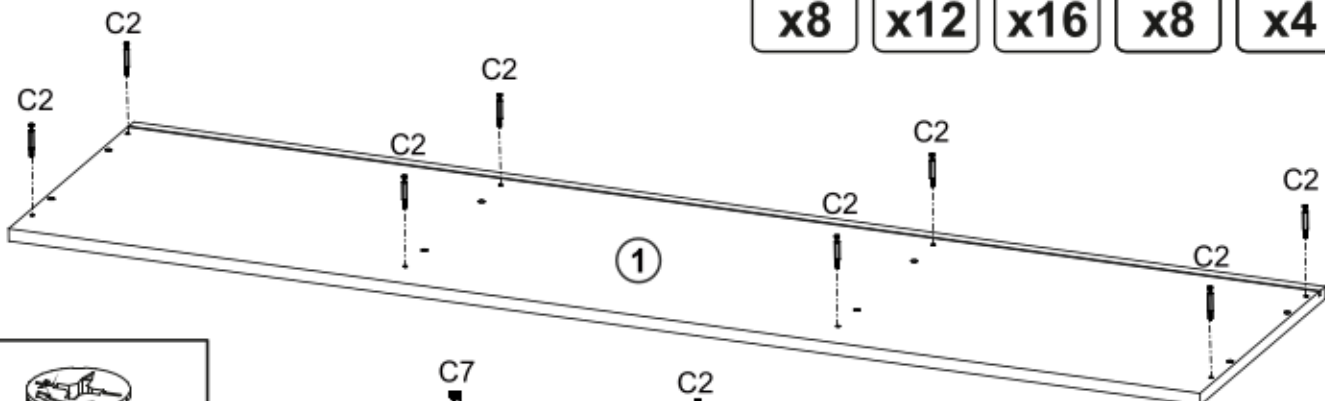



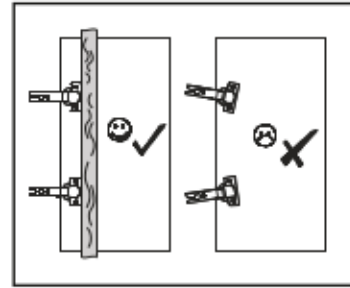

2

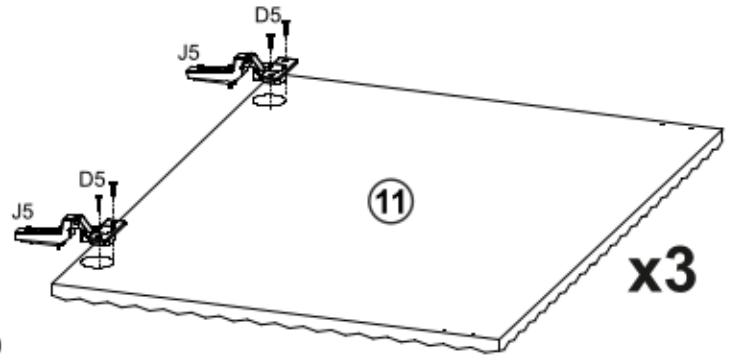
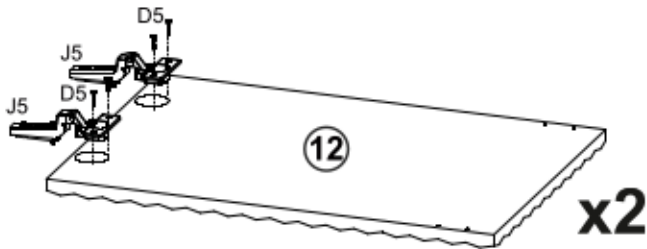
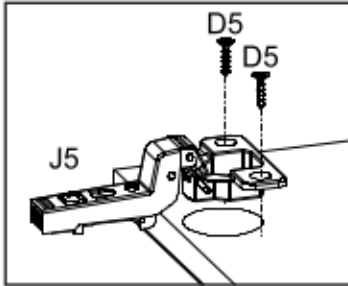

D5	J5
	
3.5x16	
x20	x10



3

A0	C7	Q1	Q3
			
Ø8x30	16 mm		
x8	x4	x4	x8

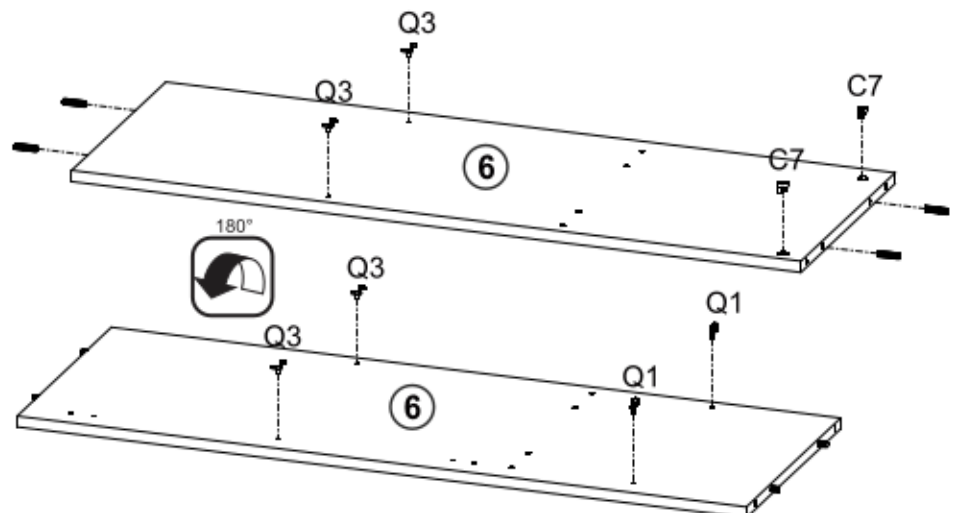
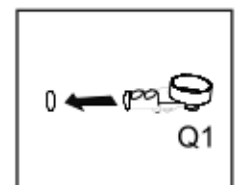
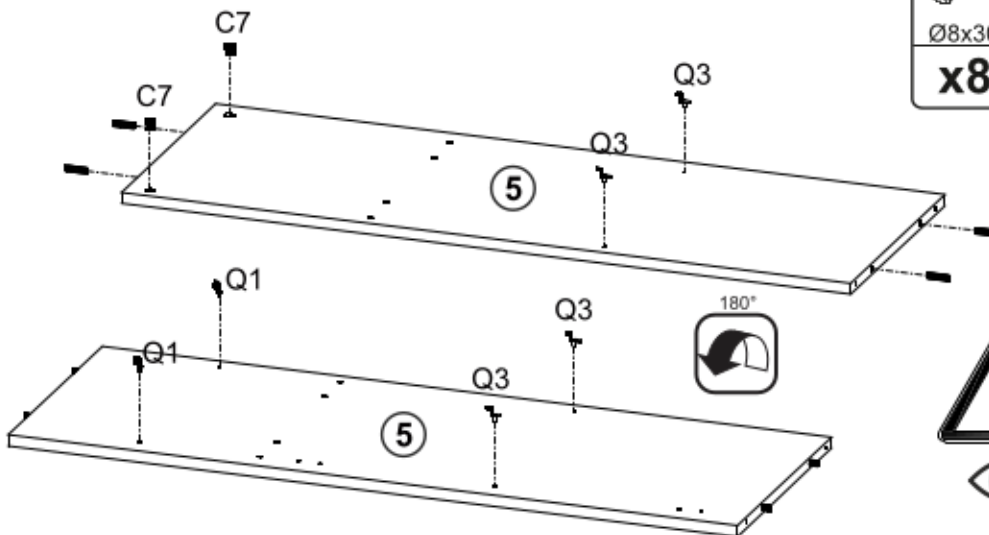

4

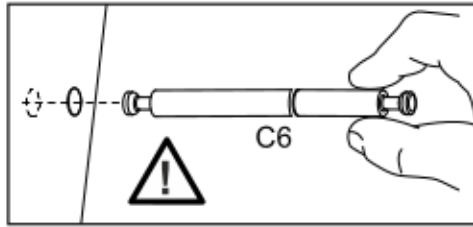
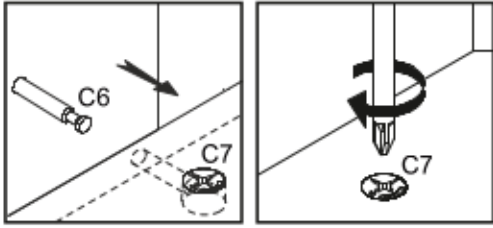

A0	A1	C6
Ø8x30	Ø8x50	84 mm
x4	x4	x4

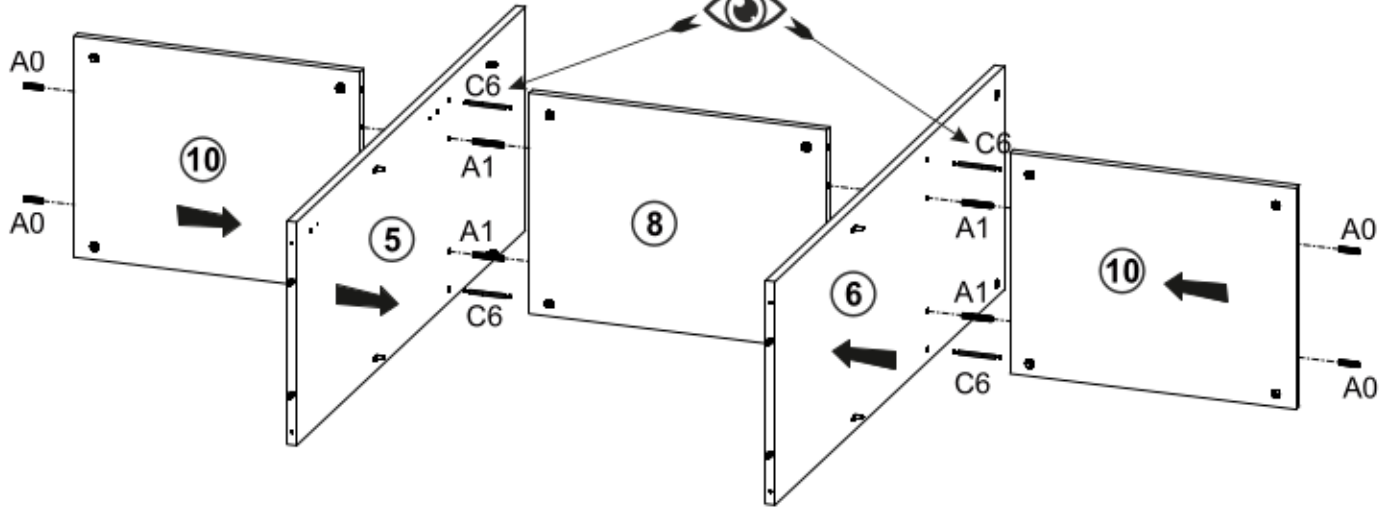

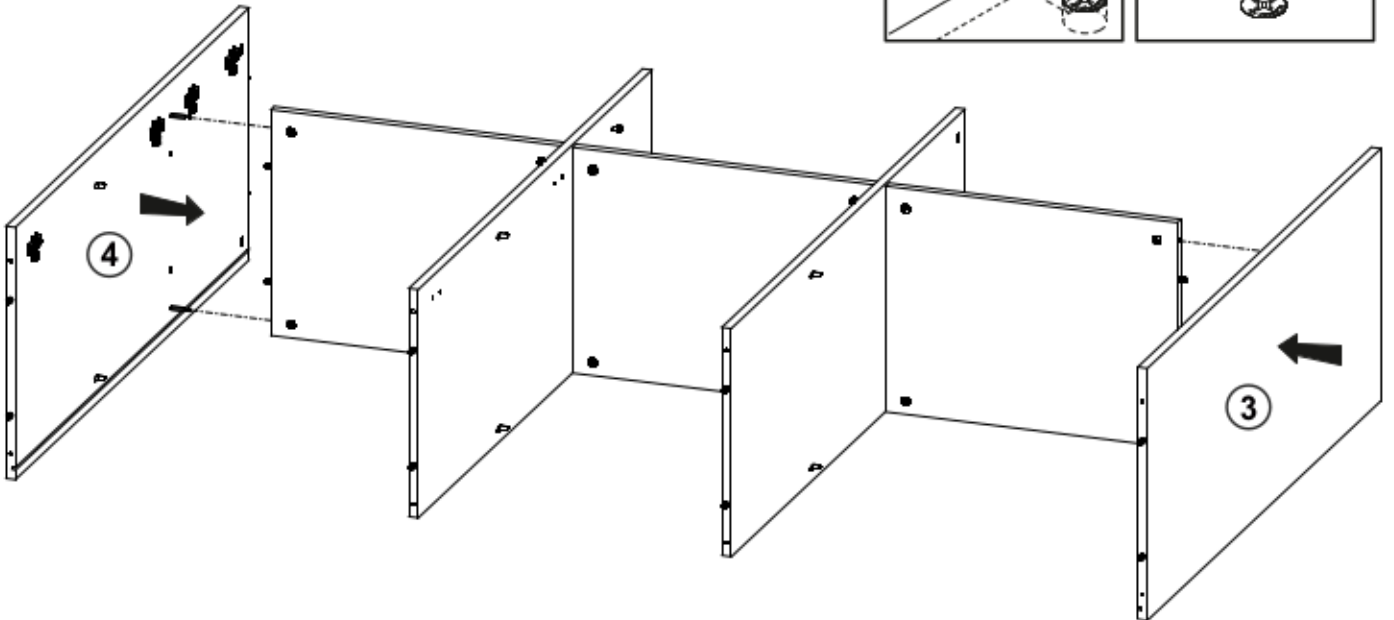
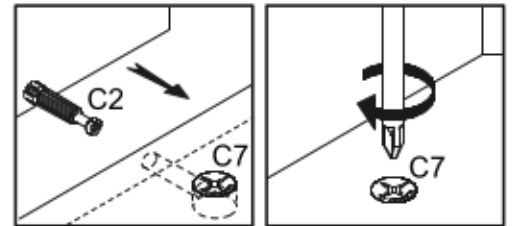

5

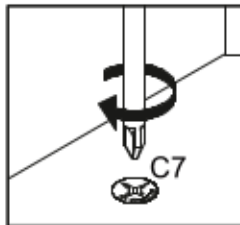
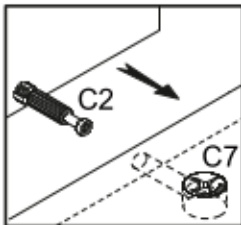
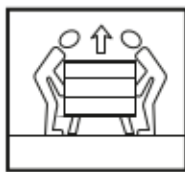

6



B1	K
 Ø7x50	 4mm
x8	x1

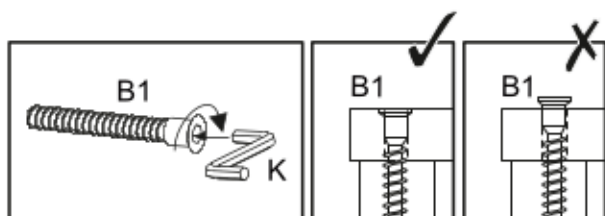
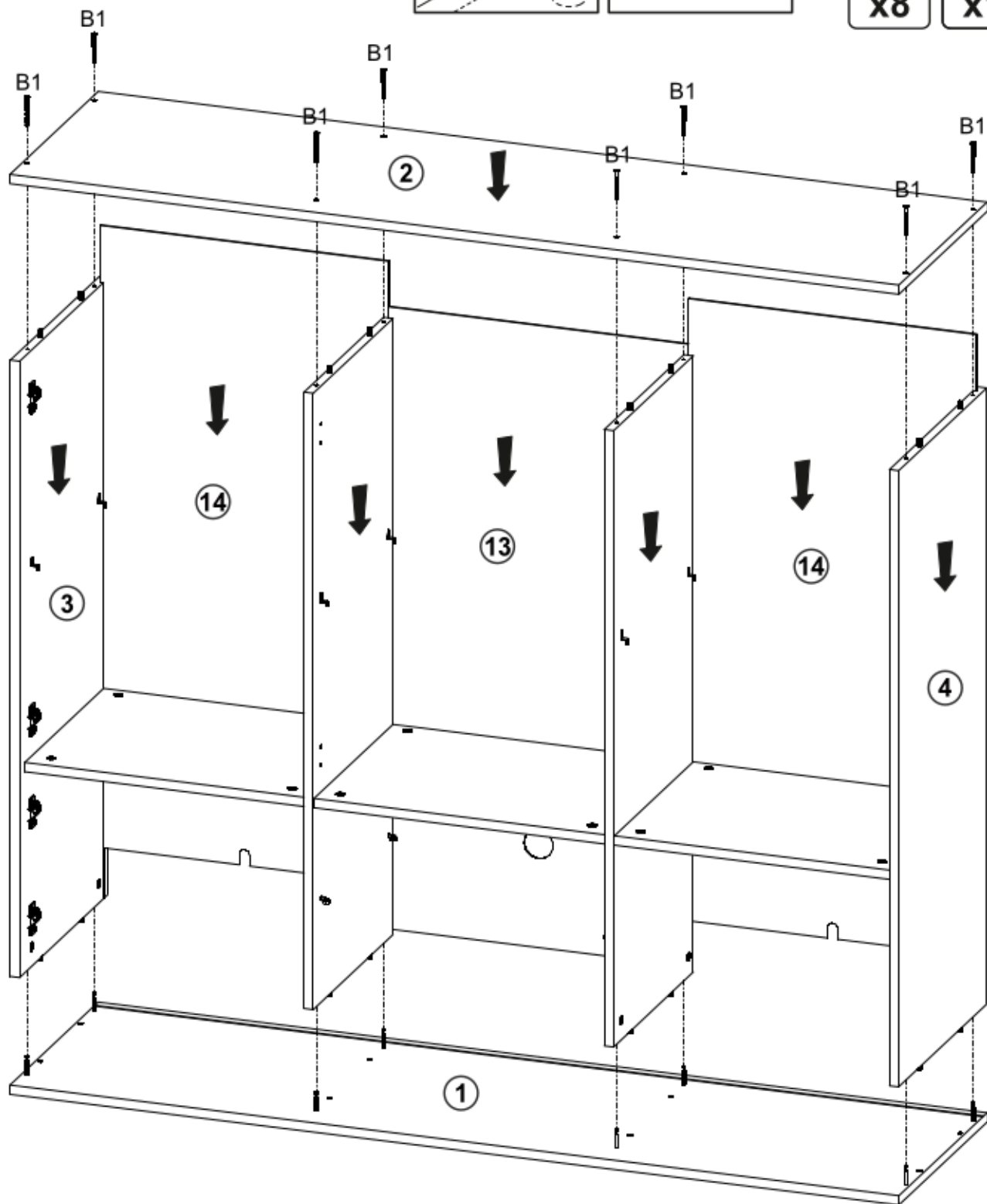

7

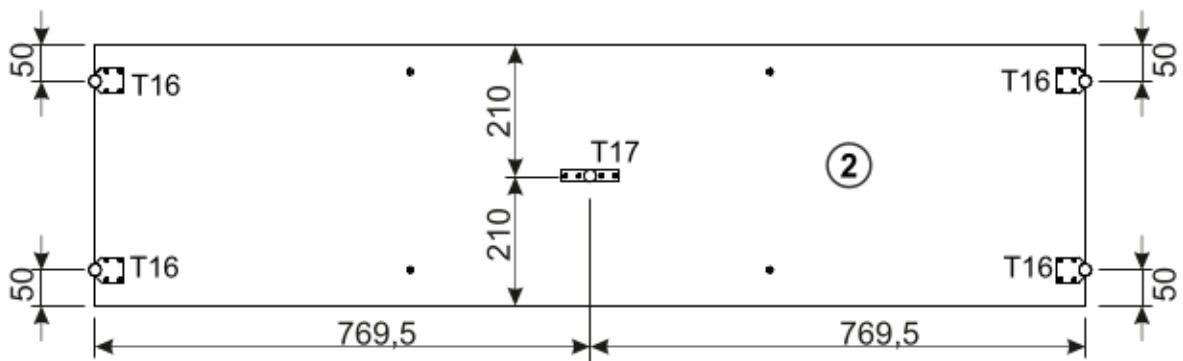
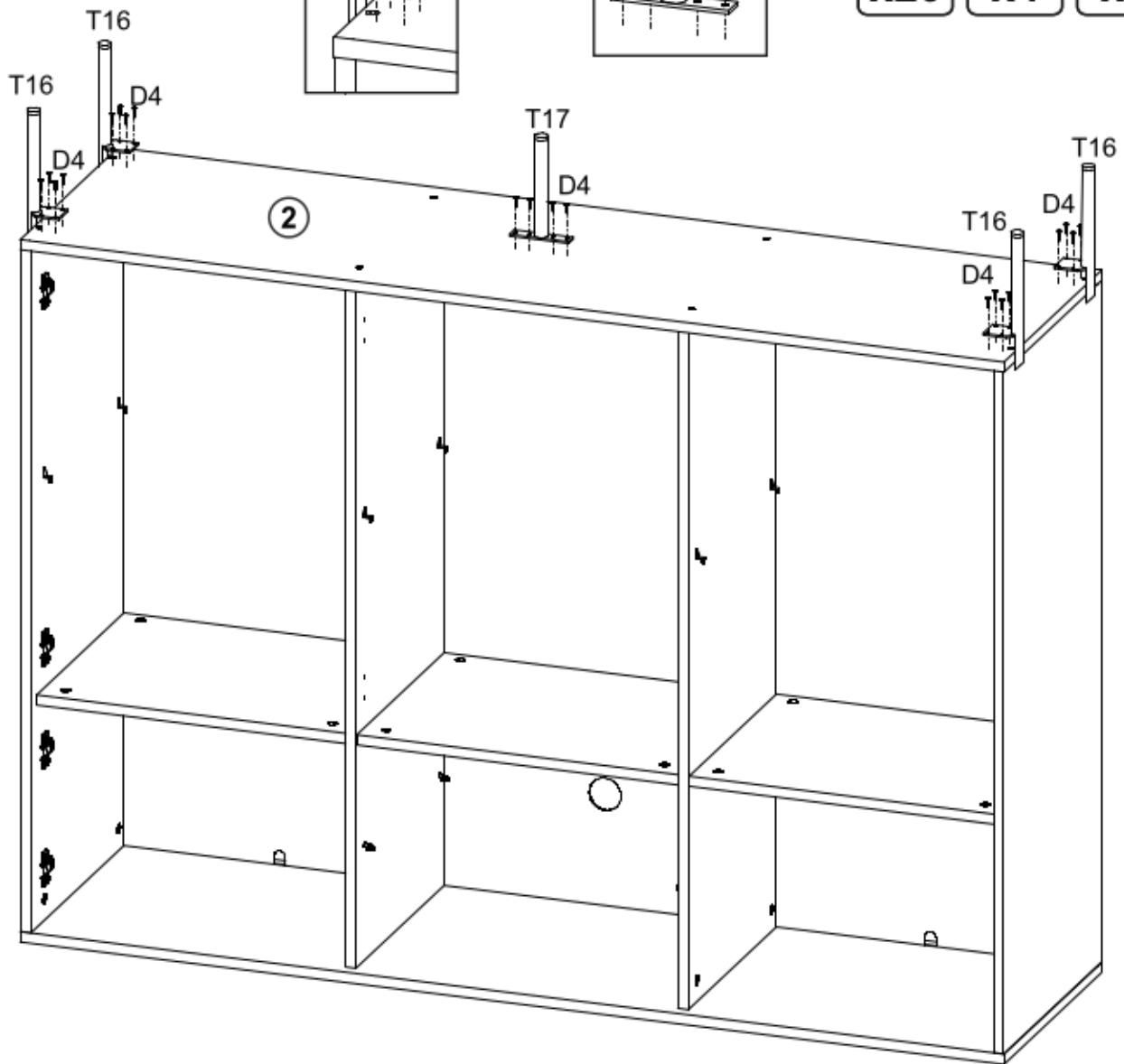
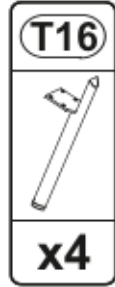
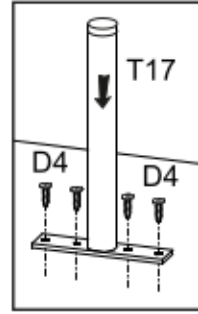
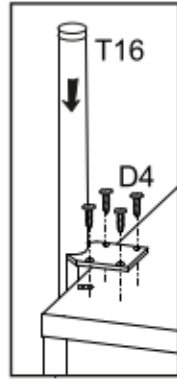

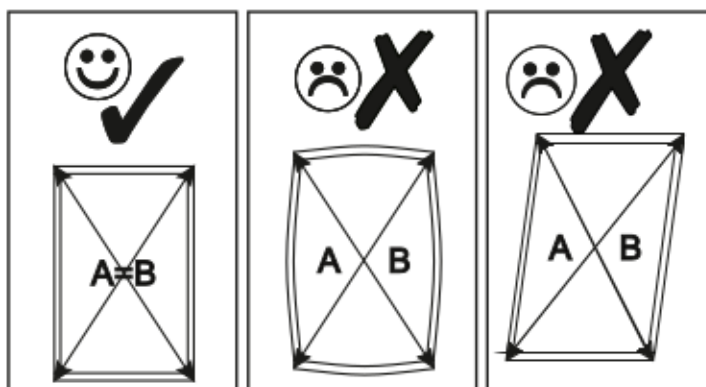
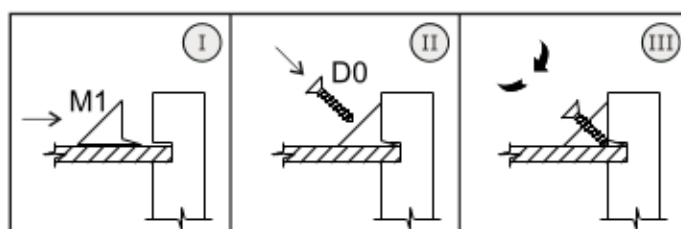
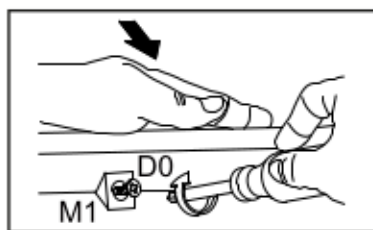
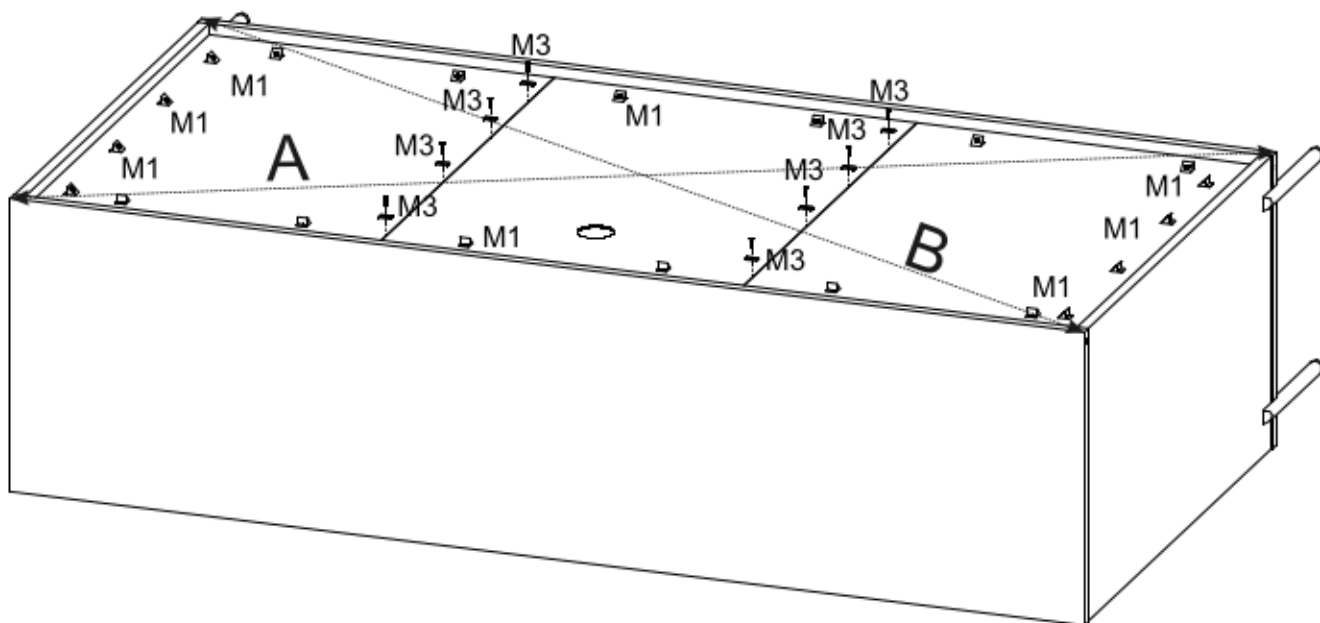
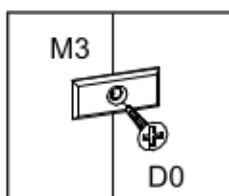

8



9



D5	E0	P0
		
3.5x16	8x50	
x4	x2	x2

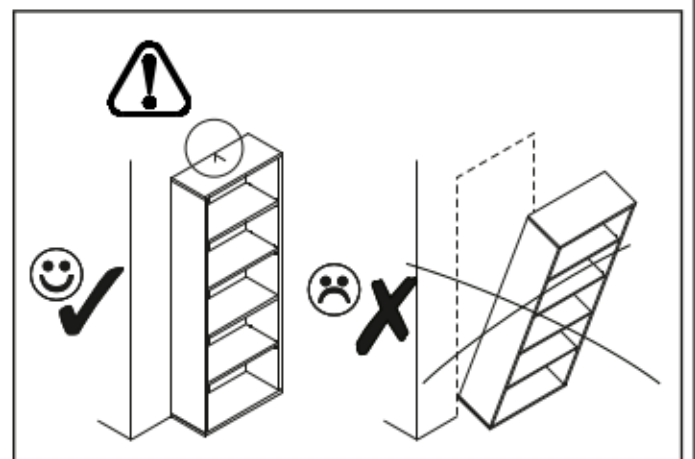
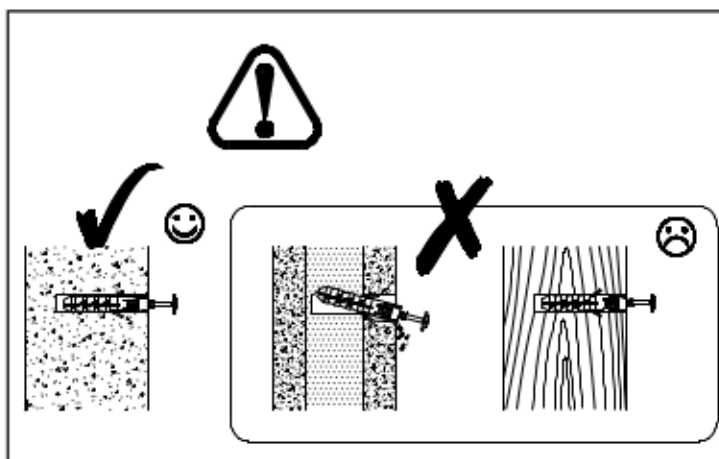
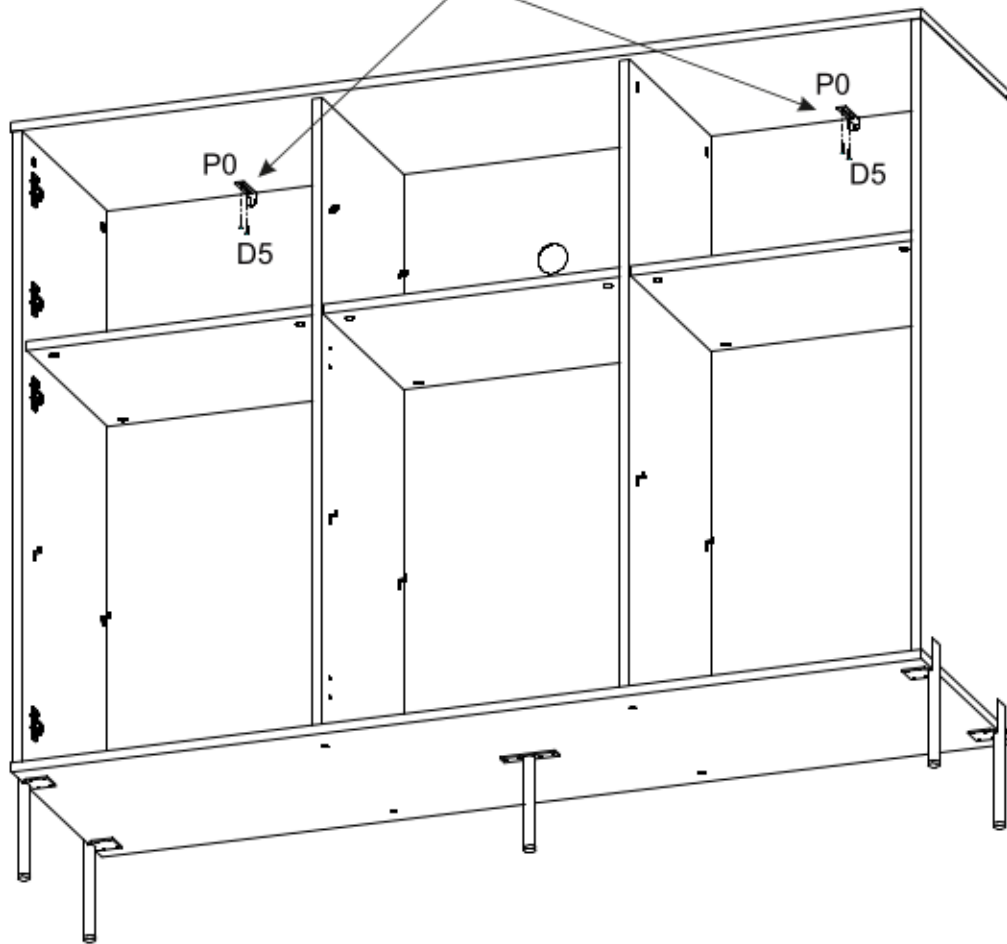
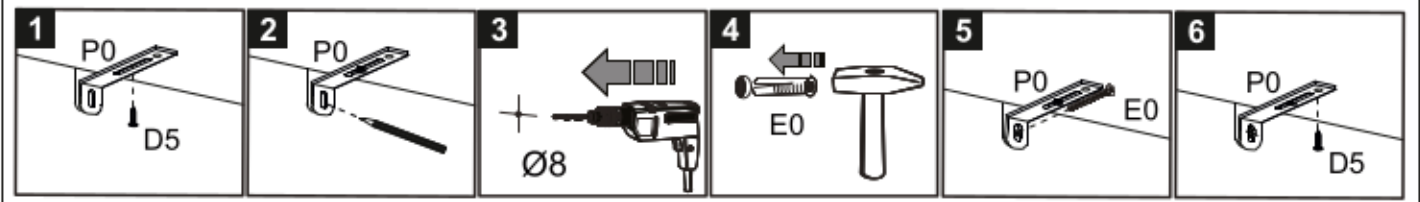

10

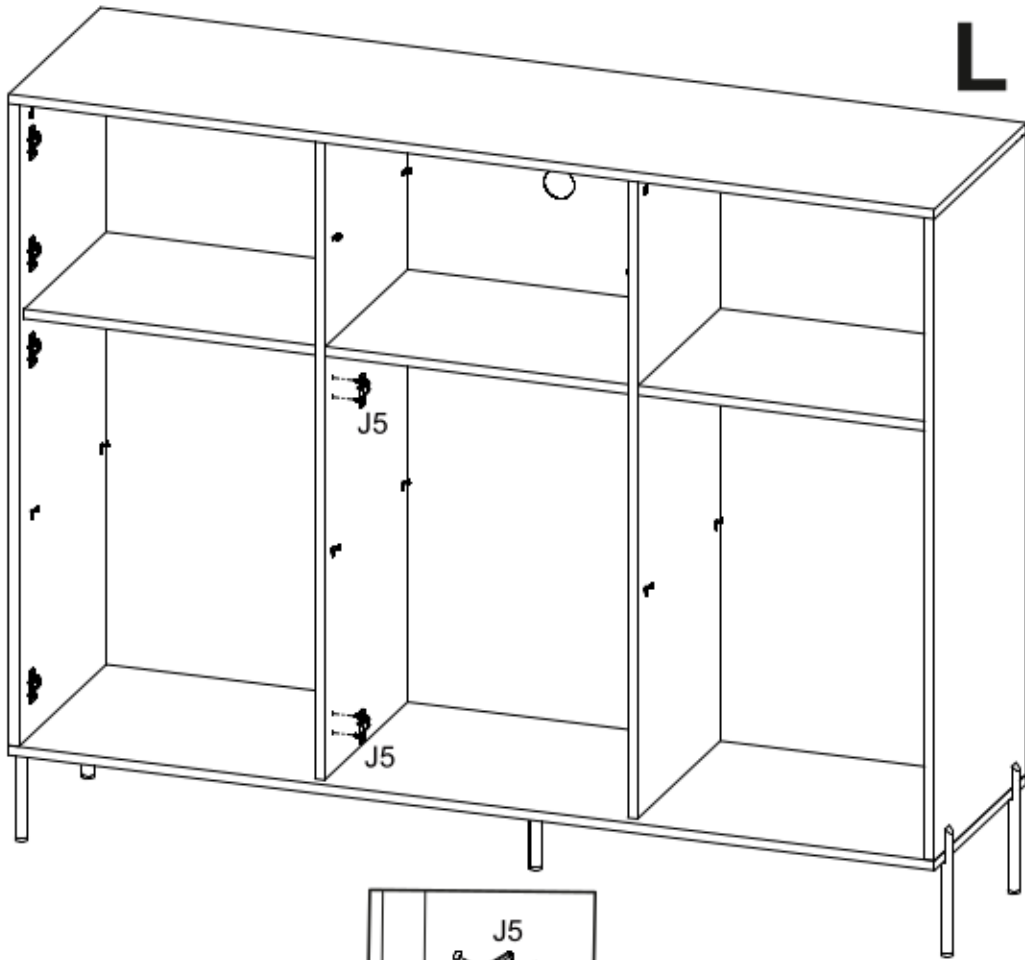

J5

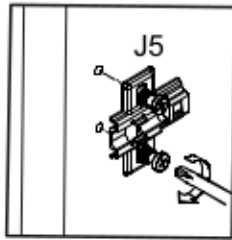

x2

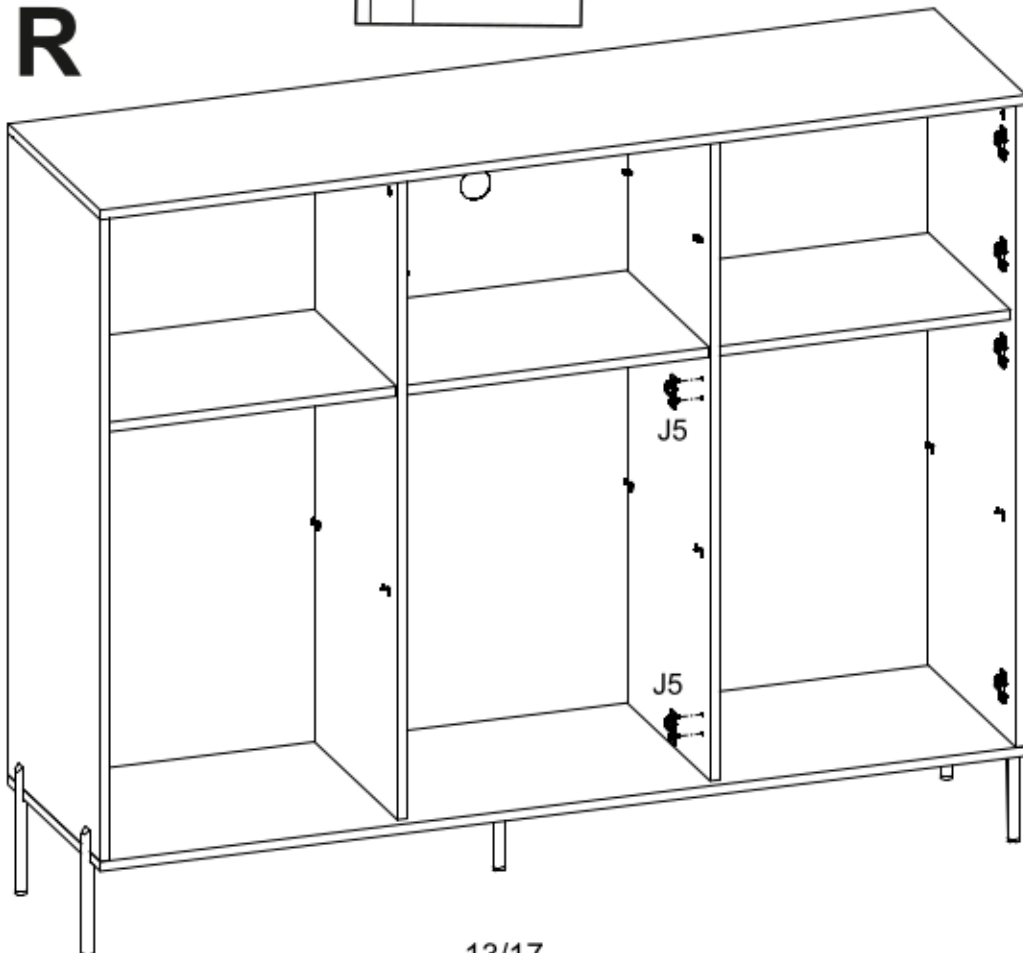

R





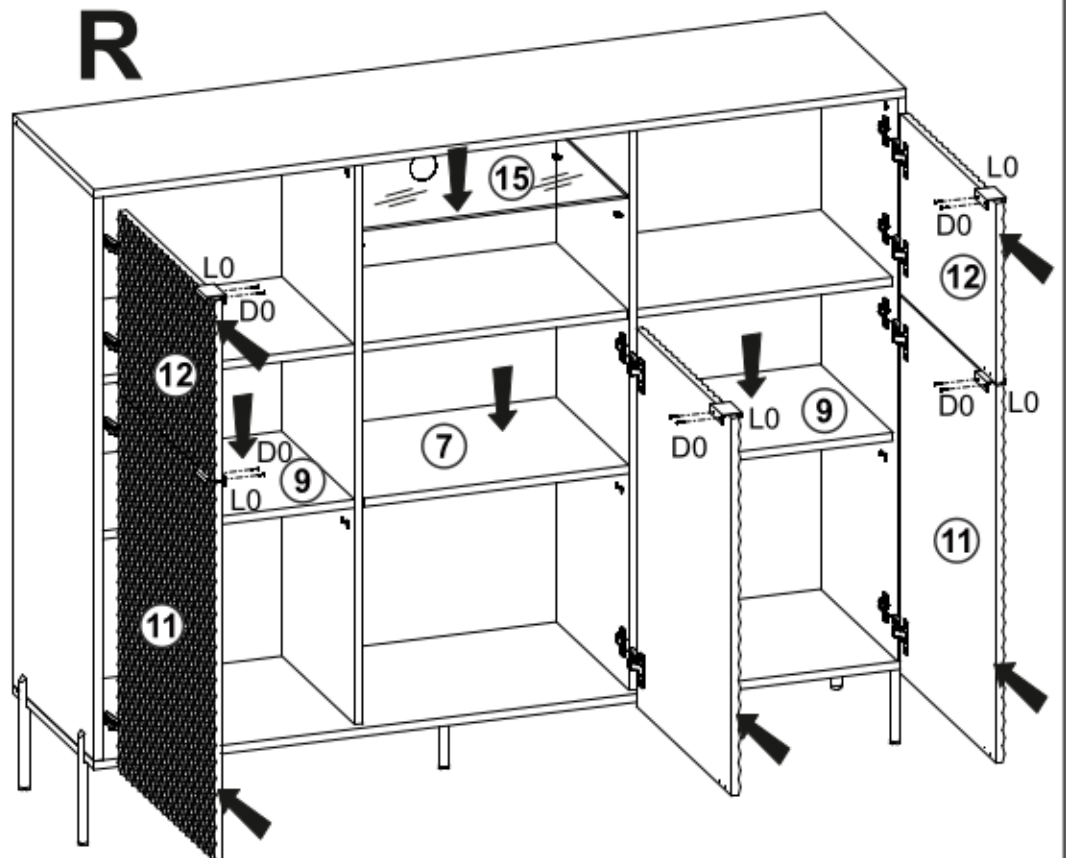
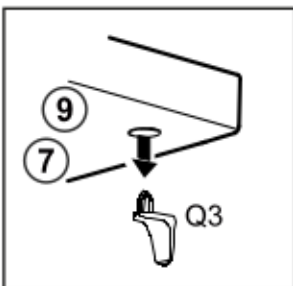
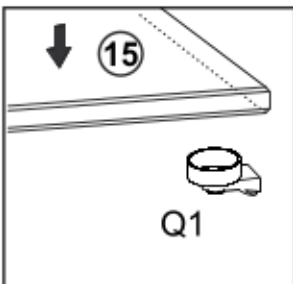
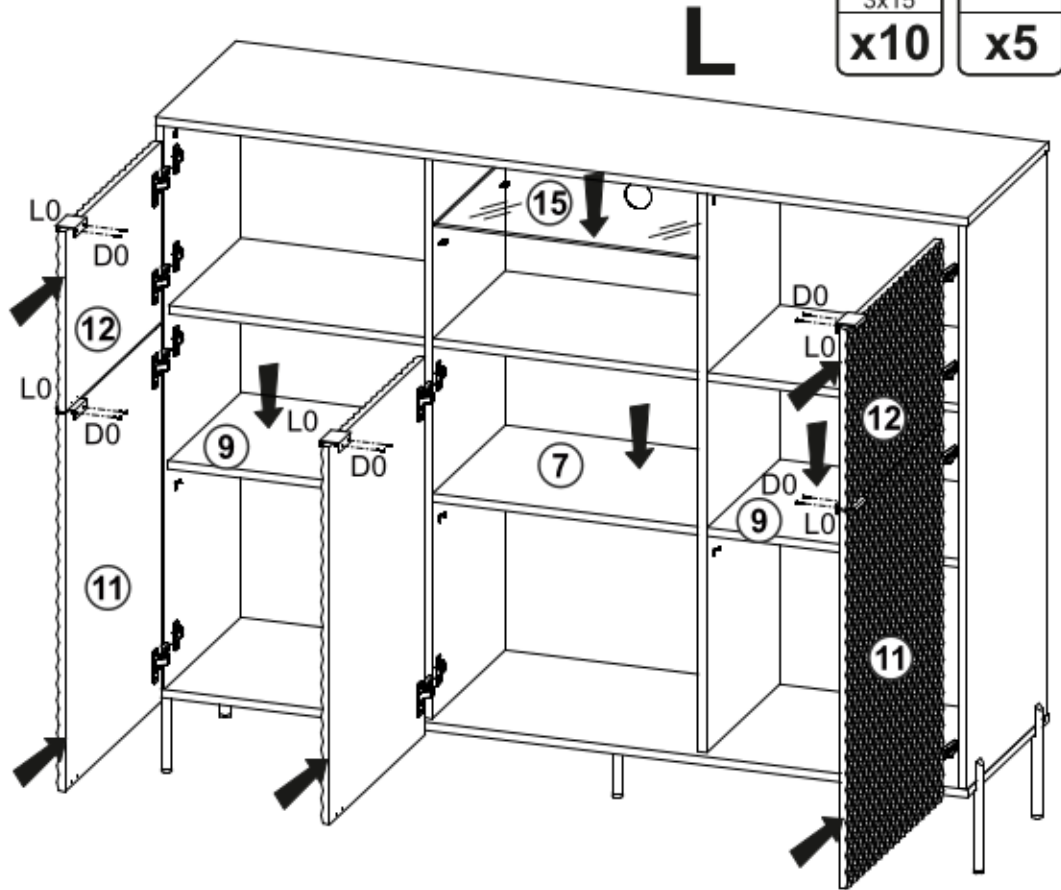
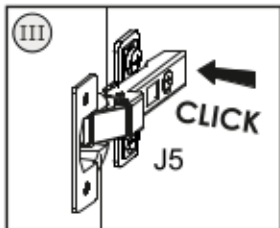
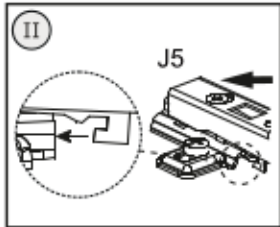
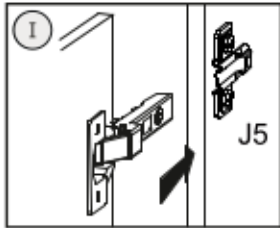

11

(D0)	(L0)
	
3x15	
x10	x5

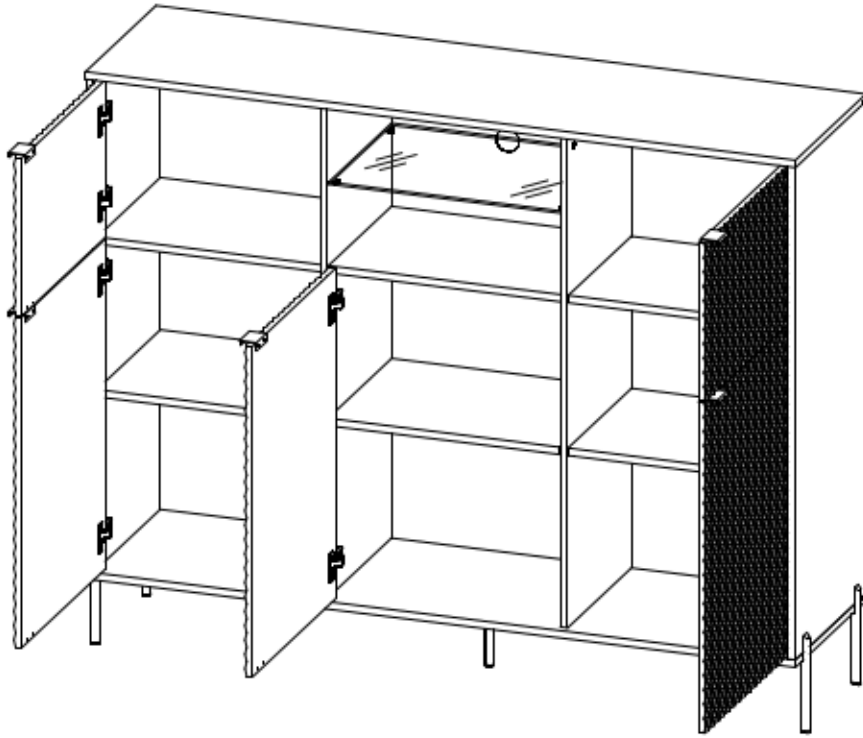

12



B3	B4	C4
		
Ø5		
x4	x4	x20

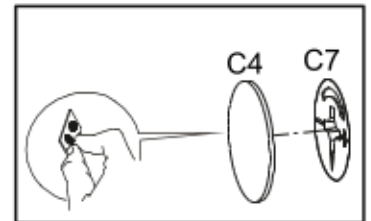
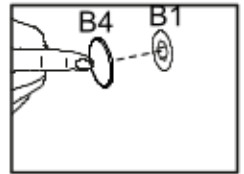

R

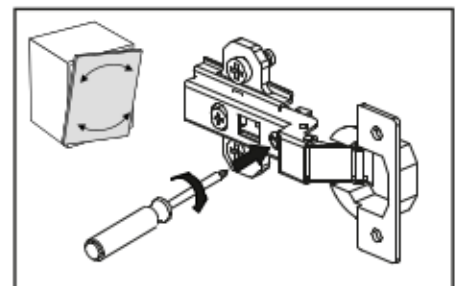
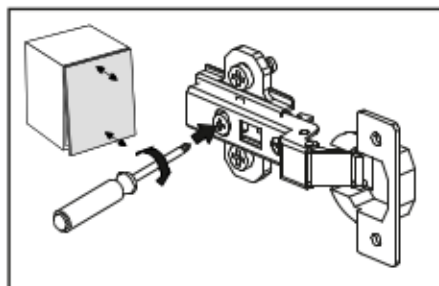
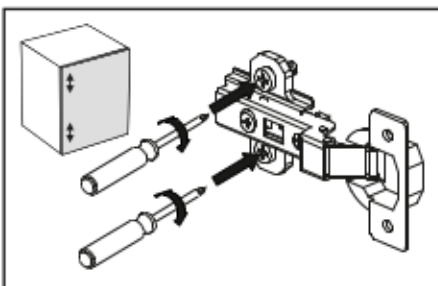
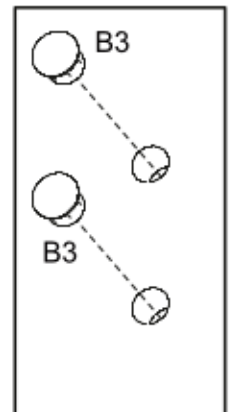
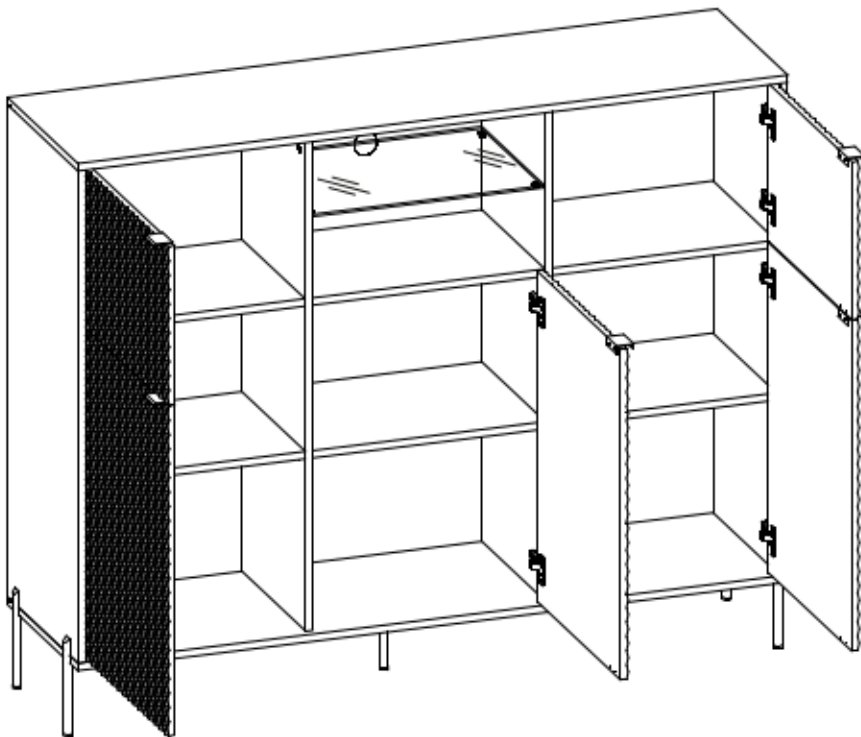

13

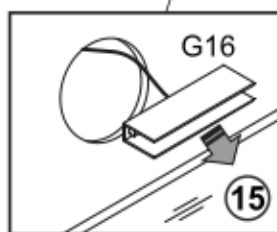
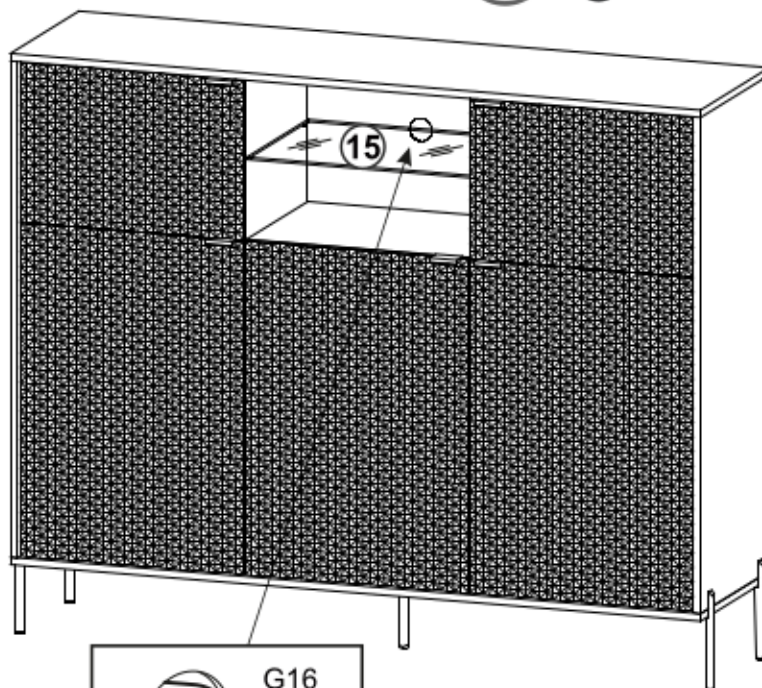
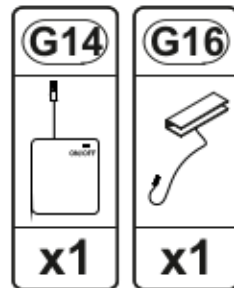
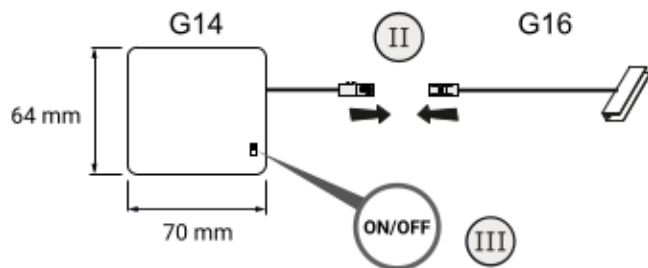

R

