

- PL Instrukcja montażu
- D Montageanleitung
- NL Handleiding voor de montage
- TR Montaj talimatı
- F Notice de montage
- CZ Montážní návod
- HU Szerelési útmutató
- GB Assembly instructions
- RU Инструкция по монтажу
- IT Istruzioni di montaggio
- SK Návod na montáž
- RO Instrucțiuni de montaj
- ES Instrucciones de montaje

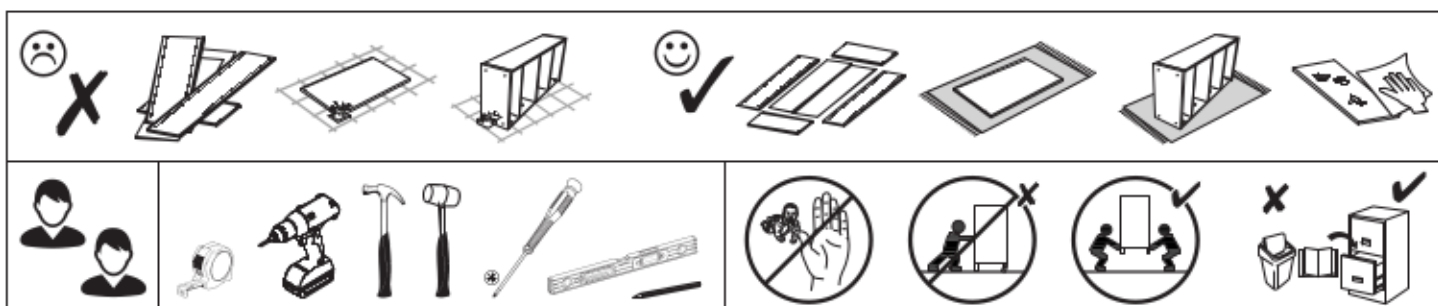

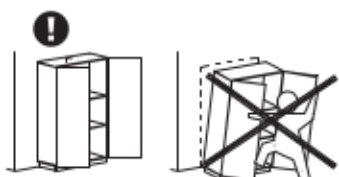
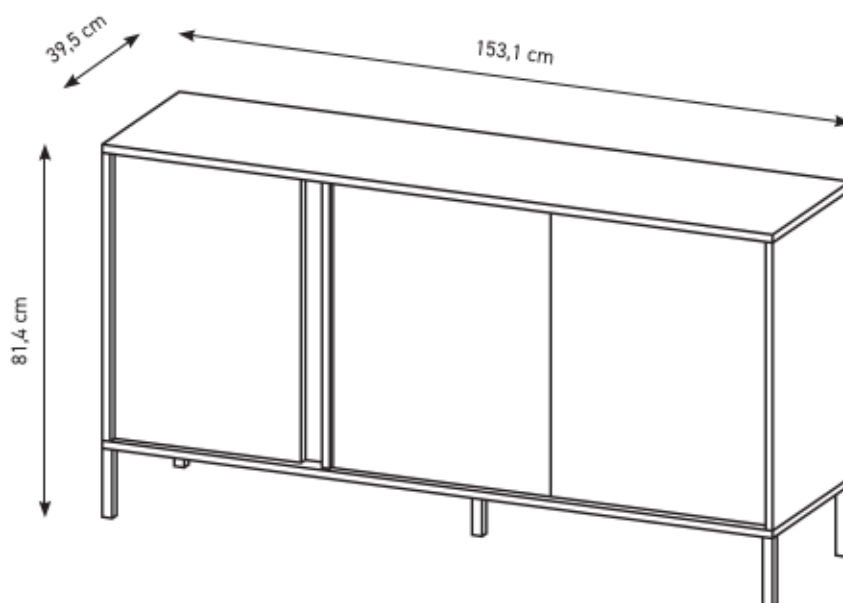

PL Przed rozpoczęciem montażu mebla wszystkie elementy należy sprawdzić czy nie są uszkodzone. W przypadku wykrycia uszkodzenia elementu należy odstąpić od montażu mebla i złożyć reklamację. Montaż produktu w oparciu o uszkodzone elementy oznacza akceptację ich stanu przez Kupującego, co powoduje, że reklamacja uszkodzonych elementów nie będzie uznawana.

Nie wolno przekraczać podanych maksymalnych wartości obciążenia. W innym przypadku można mebel uszkodzić lub zniszczyć.

Przed zawieszeniem mebla, lub przymocowaniem go do ściany (w celu zabezpieczenia przed przewróceniem), sprawdź wcześniej rodzaj i wytrzymałość ściany. Dobierz odpowiednie kołki i wkręty do rodzaju ściany. W przypadku wątpliwości skontaktuj się ze specjalistą. Montaż musi zostać wykonany przez osobę kompetentną.

D Vor Beginn der Möbelmontage sollten alle Elemente auf Beschädigungen überprüft werden. Wenn ein Element des Produkts beschädigt ist, installieren Sie das Produkt bitte nicht und reichen Sie eine Beschwerde ein. Die Installation des Produkts auf der Grundlage der beschädigten Elemente bedeutet, dass der Käufer seinen Zustand akzeptiert, was bedeutet, dass die Beschwerde über beschädigte Elemente nicht akzeptiert wird.

Überschreiten Sie die angegebenen Maximalbelastungen nicht. Andernfalls kann das Möbelstück beschädigt oder zerstört werden.

Bevor Sie ein Möbelstück an einer Wand aufhängen oder befestigen (um es gegen Umkippen zu sichern), prüfen Sie Art und Tragfähigkeit der Wand. Wählen Sie die für die Wand geeigneten Dübel und Schrauben. Im Zweifelsfall kontaktieren Sie bitte einen Fachmann. Die Montage muss durch eine sachkundige Person ausgeführt werden.

F Avant de commencer l'assemblage du meuble, tous les éléments doivent être vérifiés pour détecter tout dommage. Si un élément du produit est endommagé, veuillez ne pas installer le produit et déposer une plainte. L'installation du produit sur la base des éléments endommagés signifie que l'acheteur accepte leur état, ce qui signifie que la réclamation d'éléments endommagés ne sera pas acceptée.

Ne dépassez pas les charges maximum indiquées. Sinon, le meuble peut être endommagé ou détruit.

Avant de suspendre le meuble ou de le fixer au mur (dans le but d'éviter un renversement), vérifiez au préalable le type et la résistance du mur. Utilisez les chevilles et les vis adaptées au type de mur. En cas de doute, veuillez contacter un spécialiste. Le montage doit être réalisé par une personne compétente.

CZ Před zahájením montáže nábytku je třeba zkontrolovat poškození všech prvků. Pokud je některý prvek produktu poškozen, zdržte se instalace produktu a podejte stížnost. Instalace výrobku na základě poškozených prvků znamená, že kupující akceptuje jejich stav, což znamená, že reklamacie poškozených prvků nebude uznána. Nepřekračujte uvedené maximální zatížení. V opačném případě může dojít k poškození nebo zničení nábytku.

Před zavěšením nábytku nebo jeho připevněním ke zdi (za účelem zajištění před převrácením) dříve zkontrolujte druh a odolnost stěny. Vyberte k druhu stěny vhodné hmoždinky a šrouby. V případě pochybností kontaktujte specialistu. Montáž musí být provedena kompetentní osobou.

HU A bútor szerelés megkezdése előtt ellenőrizni kell az összes elem sérülését. Ha a termék bármely eleme megsérült, kérjük, tartózkodjon a termék telepítésétől és nyújtson be panaszt. A termék sérült elemek alapján történő felszerelés azt jelenti, hogy a Vevő elfogadja azok állapotát, ami azt jelenti, hogy a sérült elemek igényét nem fogadják el. A megadott maximális terhelési értékeket nem szabad túllépni. Ellenkező esetben a bútor megsérülhet vagy megsemmisülhet.

A bútor felüggesztése illetve falhoz való rögzítése (megakadályozván ezzel eldőléseinek lehetőségét) előtt ellenőrizze a fal fajátját és szilárdságát. Megfelelő, a falhoz illő tipliket és csavarokat használjon. Ha kétsége támadna, konzultáljon szakemberrel. A felszerelési csakis egy hozzáértő szakember végezheti el.

GB Before starting the furniture assembly, all elements should be checked for damage. If any element of the product is damaged, please refrain from installing the product and file a complaint. Installation of the product on the basis of the damaged elements means the Buyer's acceptance of their condition, which means that the complaint of damaged elements will not be accepted.

The specified maximum load values must not be exceeded. Otherwise, the piece of furniture may be damaged or destroyed.

Before suspending or fixing furniture to the wall (in order to prevent falling over), check the type and strength of the wall. Select wall plugs and screws appropriate for the given type of the wall. In the case of doubts, contact a specialist. The installation must be performed by a competent person.

SK Pred začatím montáže nábytku by sa mali skontrolovať všetky prvky, či nie sú poškodené. Ak je niektorý prvok výrobku poškodený, neinstalujte výrobok a reklamujte ho. Inštalácia produktu na základe poškodených prvkov znamená, že Kupujúci akceptuje ich stav, čo znamená, že reklamácia poškodených prvkov nebude akceptovaná. Uvedené hodnoty maximálneho zaťaženia nesmú byť prekročené. V opačnom prípade môže dôjsť k poškodeniu alebo zničeniu nábytku.

Pred zaviesaním nábytku alebo jeho pripavením na stenu (za účelom zaistenia pred prevrátením) predtým skontrolujte druh a odolnosť steny. Vyberte k druhu steny vhodné hmoždinky a skrutky. V prípade pochybností kontaktujte špecialistu. Montáž musí byť vykonaná kompetentnou osobou.

RU Перед началом сборки мебели следует проверить все элементы на предмет повреждений. Если какой-либо элемент продукта поврежден, пожалуйста, воздержитесь от установки продукта и подайте жалобу. Установка товара на поврежденные элементы означает, что Покупатель принимает их состояние, а значит, претензии по поврежденным элементам не принимаются.

Указанные максимальные значения нагрузки не должны превышать. В противном случае предмет мебели может быть поврежден или уничтожен.

Перед подвешиванием мебели или ее креплением к стене (для защиты от падений) проверьте предварительно тип и прочность стены. Подберите соответствующие типу стены дюбели и шурупы. При возникновении сомнений свяжитесь со специалистом. Монтаж должен проводиться компетентным лицом.

IT Prima di iniziare l'assemblaggio del mobile, tutti gli elementi dovrebbero essere controllati per danni. Se qualche elemento del prodotto è danneggiato, astenersi dall'installare il prodotto e presentare un reclamo. L'installazione del prodotto sulla base degli elementi danneggiati implica l'accettazione da parte dell'Acquirente della loro condizione, il che significa che il reclamo per elementi danneggiati non sarà accettato.

I valori di carico massimo specificati non devono essere superati. In caso contrario, il mobile potrebbe essere danneggiato o distrutto.

Prima di appendere i mobili oppure attaccarli al muro (per proteggerli da ribaltamenti), verifica prima la tipologia e resistenza del muro. Scegli i tasselli e viti più adatti per il tipo di muro. In caso di dubbi contattare uno specialista. Il montaggio deve essere fatto da una persona competente.

NL Voordat u met de meubelmontage begint, moeten alle elementen op schade worden gecontroleerd. Als een onderdeel van het product beschadigd is, installeer het dan niet en dien een klacht in. Installatie van het product op basis van de beschadigde elementen betekent dat de koper hun staat accepteert, wat betekent dat de claim voor beschadigde elementen niet wordt geaccepteerd.

Overschrijd de aangegeven maximale belastingen niet. Anders kan het meubelstuk worden beschadigd of vernield.

Voordat u het meubel ophangt of bevestigt tegen de muur (om het te beschermen tegen omvallen) dient u het type en de duurzaamheid van deze muur na te kijken. Maak gebruik van pluggen en schroeven die geschikt zijn voor het type muur. Neem in geval van twijfel contact op met een specialist. De assemblage dient te worden uitgevoerd door iemand met kennis van zaken.

TR Mobilya montajna başlamadan önce tüm elemanlarda hasar olup olmadığını kontrol edilmelidir. Ürünün herhangi bir parçası hasar görmüşse, lütfen ürünü kurmayın ve şikayette bulunun. Ürünün hasarlı elemanlar bazında montaj, Alıcının durumunu kabul ettiği anlamına gelir, bu da hasarlı elemanlar için talep kabul edilmeceği anlamına gelir.

Belirtilen azami yük değerini aşmayınız, aksi takdirde mobilya parçaları zarar görebilir veya kullanılamaz hale gelebilir.

Mobilyayı duvara asmadan veya montaj etmeden önce (devrilmesini önlemek için) duvarın türünü ve dayanıklılığını kontrol edin. Duvara uygun dübel ve vidaları seçin. Emin olamadığınız durumda bir uzman ile iletişime geçin. Kurulum yetkili bir kişi tarafından yapılmalıdır.

RO Înainte de a începe asamblarea mobilierului, toate elementele trebuie verificate pentru a nu se deteriora. Dacă vreun element al produsului este deteriorat, vă rugăm să vă abțineți de la instalarea produsului și să depuneți o reclamație. Instalarea produsului pe baza elementelor deteriorate înseamnă acceptarea de către Cumpărător a stării lor, ceea ce înseamnă că reclamația privind elementele deteriorate nu va fi acceptată.

Valorile maxime de sarcină specificate nu trebuie depășite. În caz contrar, piesa de mobilier poate fi deteriorată sau distrusă.

Înainte de suspendarea unei piese de mobilier sau atașarea acestuia la perete (pentru a preveni bascularea), verificați în prealabil tipul și gradul de rezistență a peretelui. Montați diblurile și șuruburile adecvate pentru tipul de perete. În caz de îndoieli, consultați un specialist. Instalarea trebuie să fie efectuată de către o persoană competentă.

ES Antes de comenzar el montaje de los muebles, todos los elementos deben comprobarse en busca de daños. Si algún elemento del producto está dañado, absténgase de instalar el producto y presente una queja. La instalación del producto sobre la base de los elementos dañados supone la aceptación por parte del Comprador de su estado, por lo que no se aceptará la reclamación de elementos dañados.

No se deben exceder los valores de carga máxima especificados. De lo contrario, el mueble puede dañarse o destruirse.

Antes de colgar o fijar el mueble en el muro (a fin de proteger contra el vuelco del mueble), compruebe de antemano la naturaleza y la resistencia de la pared. Seleccione tacos y tornillos adecuados para el tipo de la pared. En caso de duda, consulte a un especialista, debiendo efectuar este montaje una persona competente.

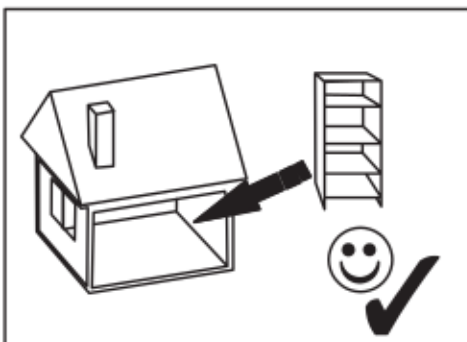
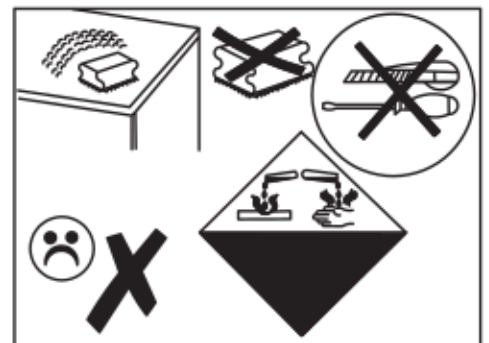
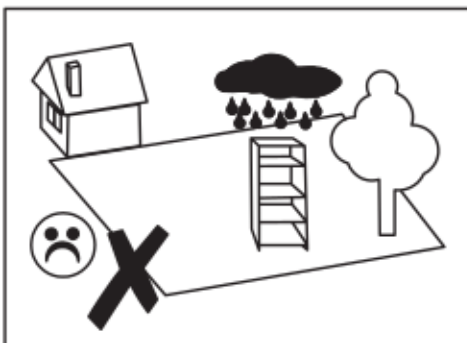

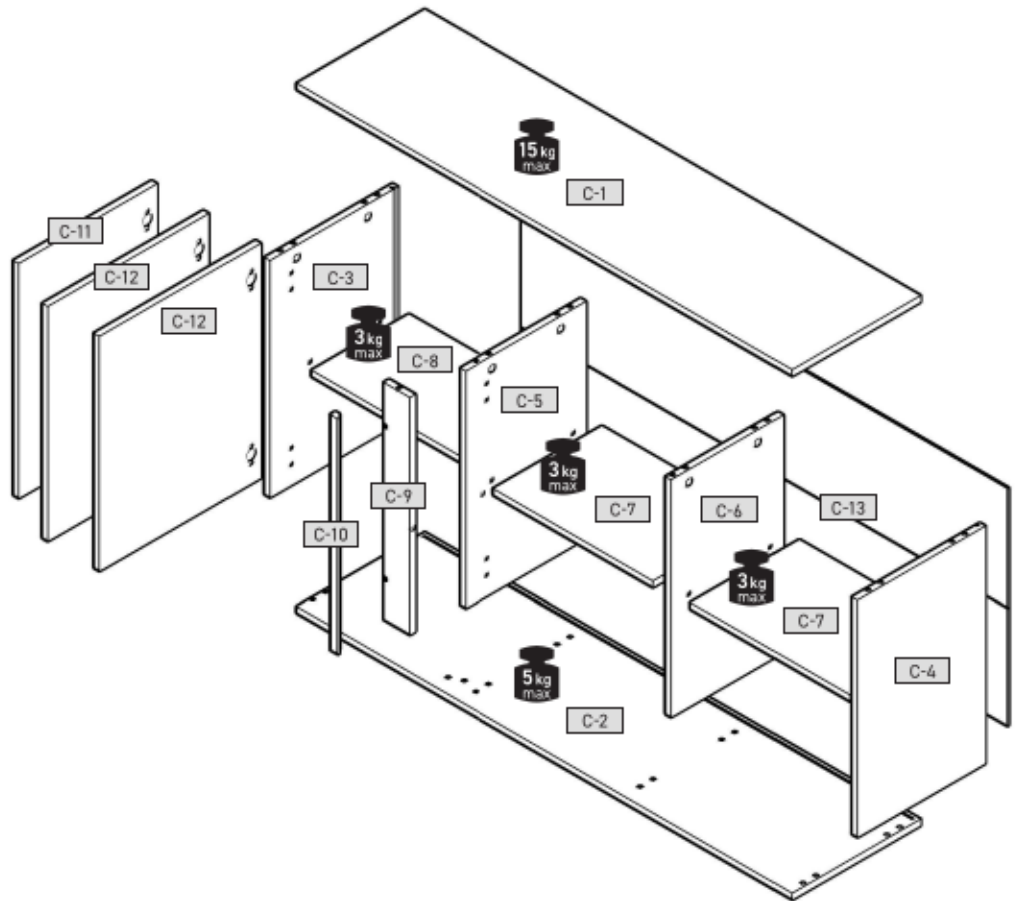
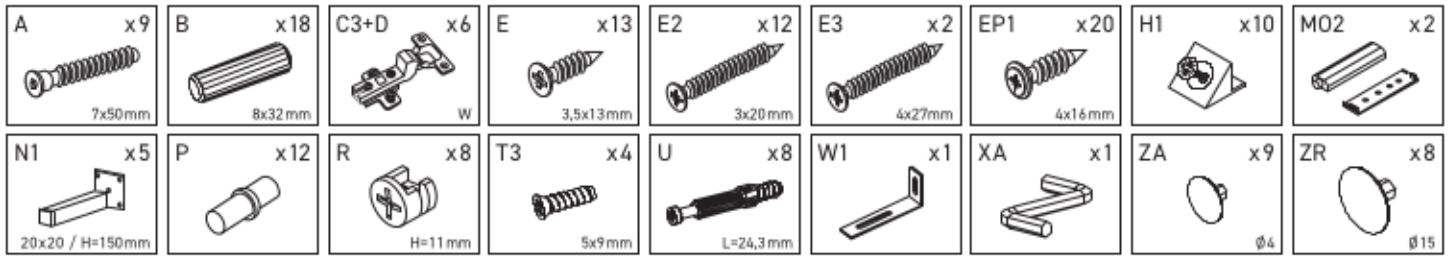

C-1	1531	395	16	x1	1/2
C-2	1531	395	16	x1	1/2
C-3	632	394	16	x1	1/2
C-4	632	394	16	x1	1/2
C-5	632	372	16	x1	1/2
C-6	632	345	16	x1	1/2
C-7	492	335	16	x2	1/2
C-8	482	300	16	x1	1/2
C-9	632	90	16	x1	1/2
C-10	628	24	16	x1	1/2
C-11	426	626	16	x1	2/2
C-12	496	626	16	x2	2/2
C-13	1512	646	3	x1	1/2

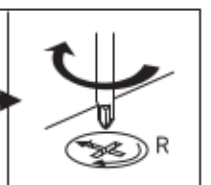
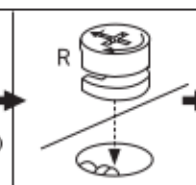
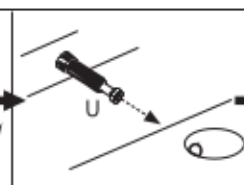
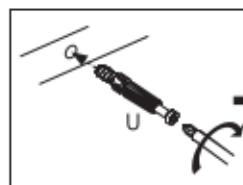
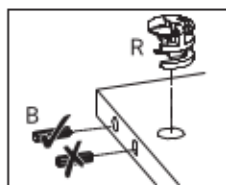
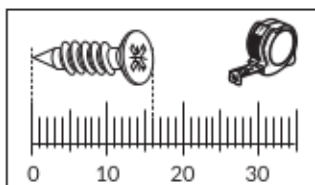

1

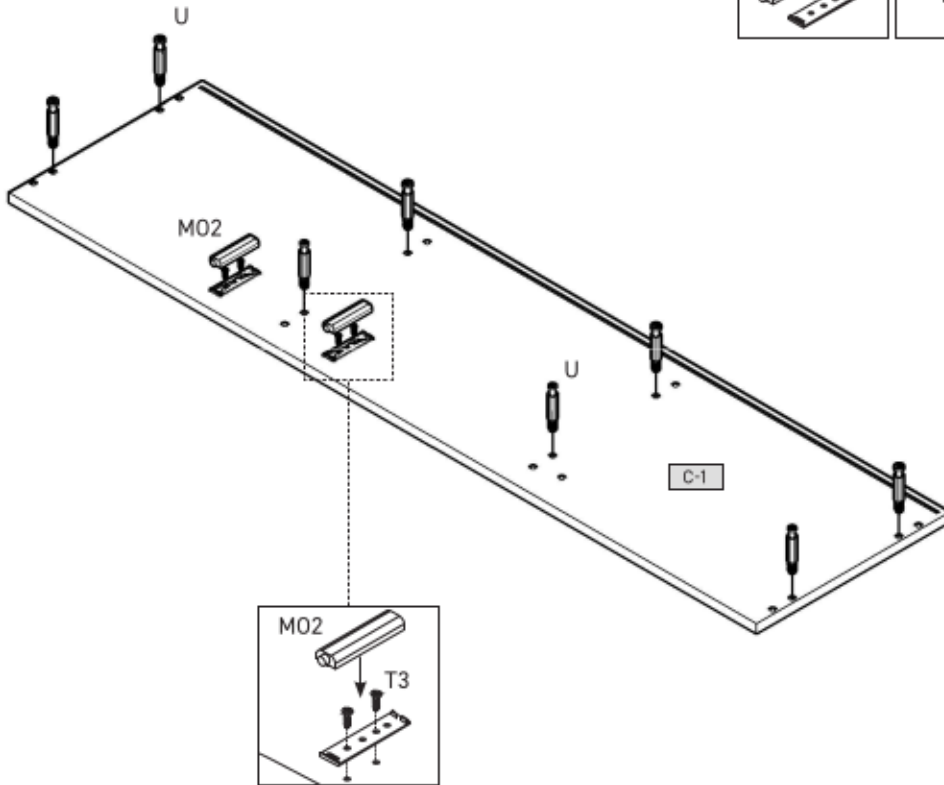
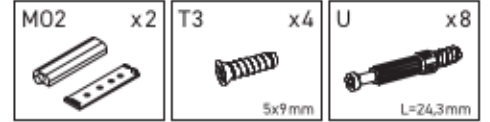

2

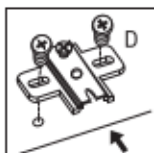
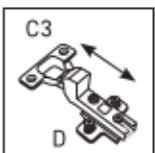
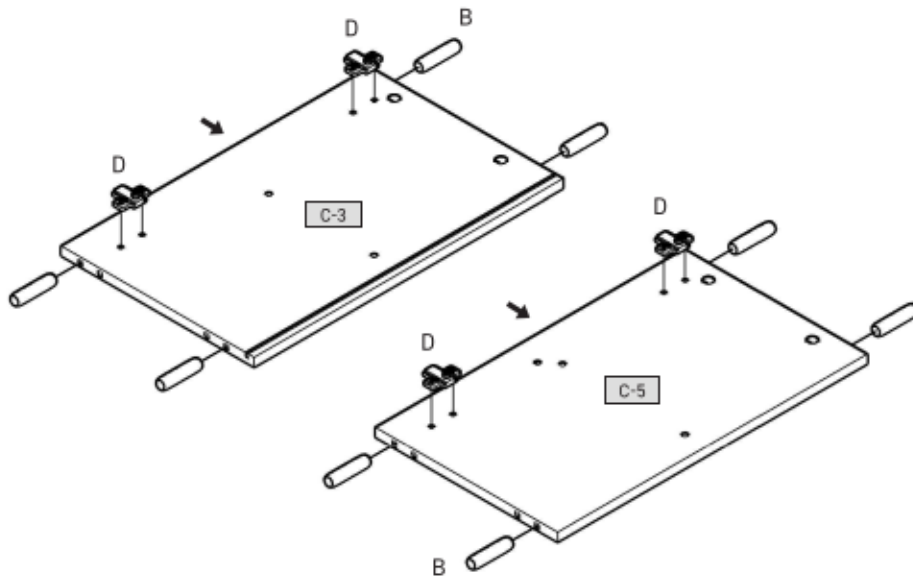
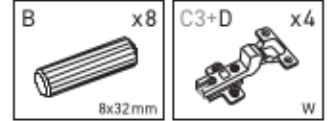

3

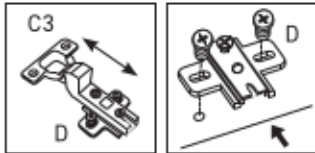
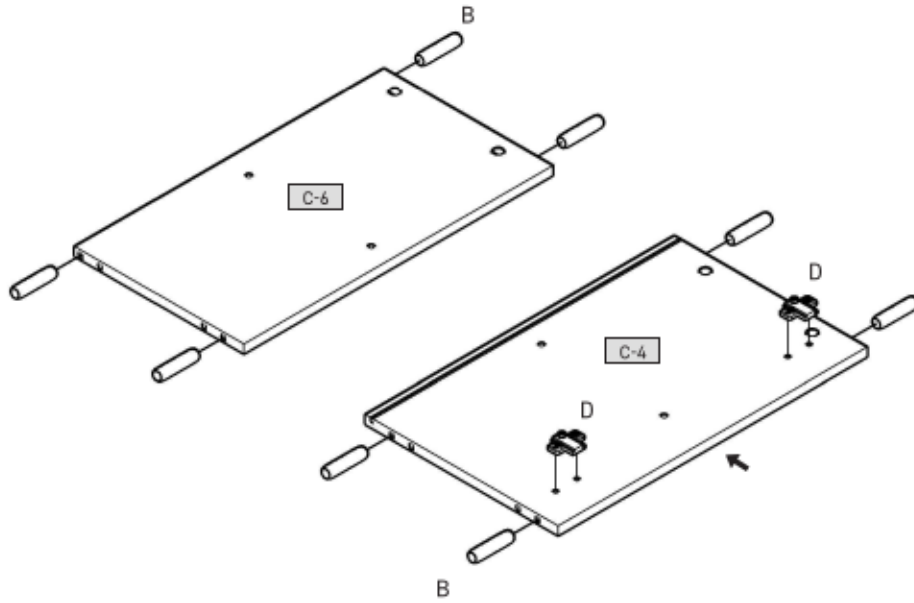
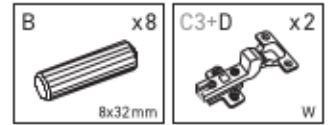

4

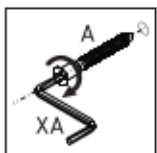
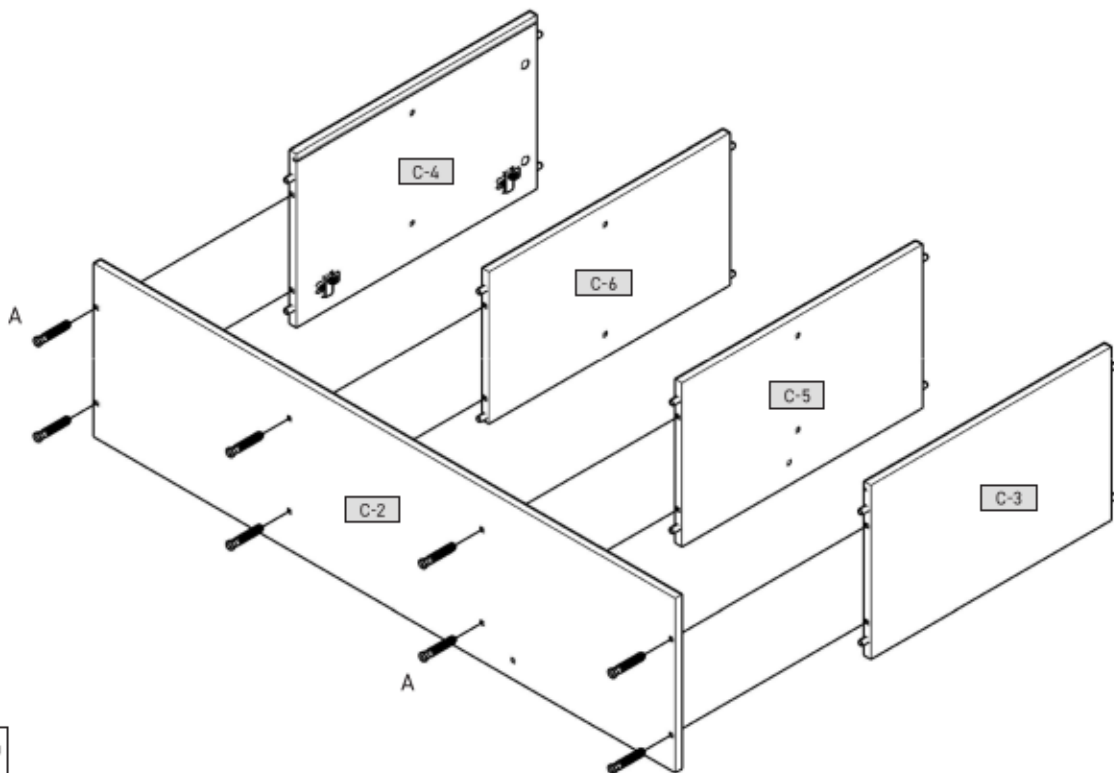
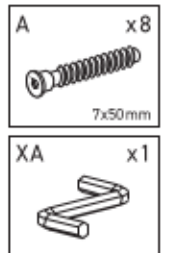

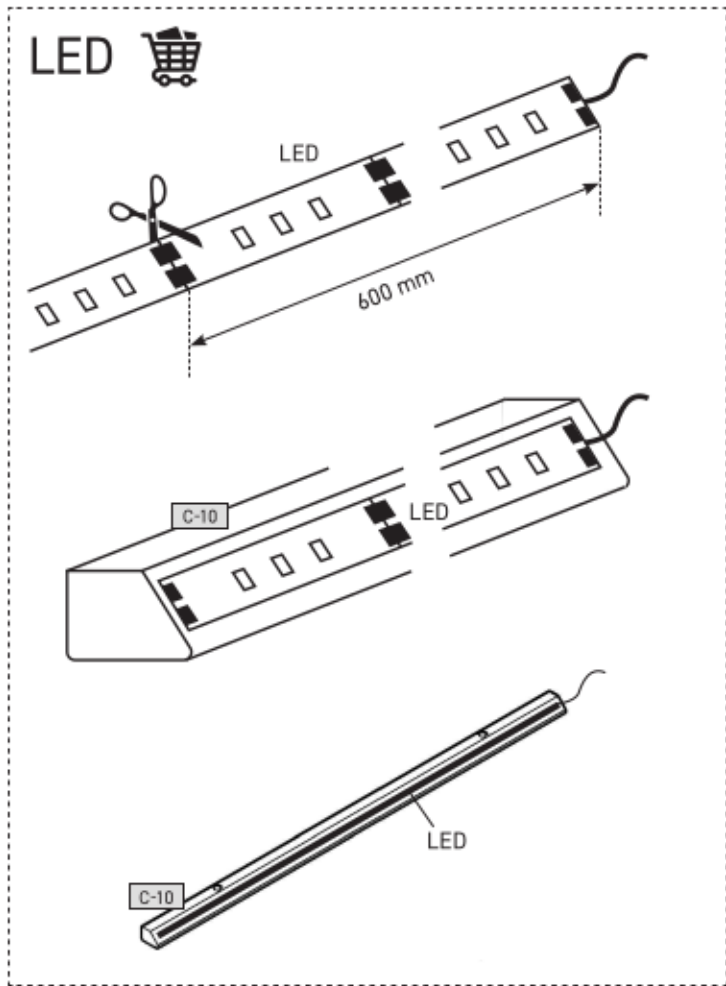

5

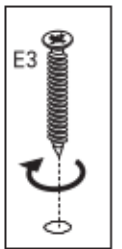
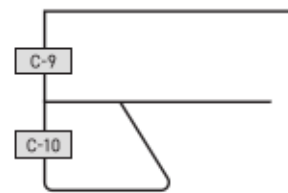
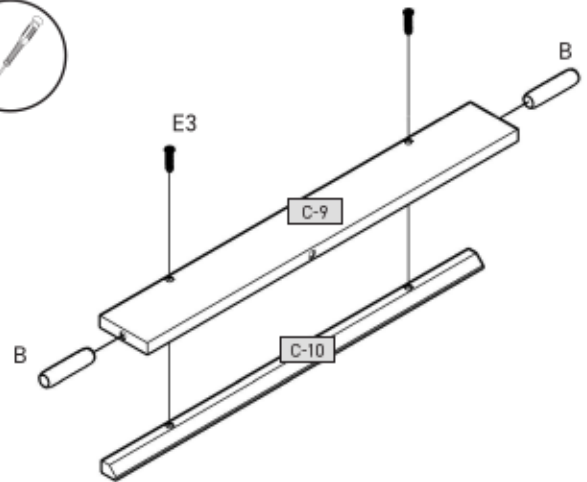
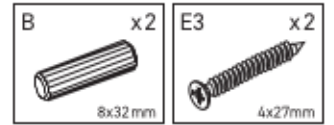

6

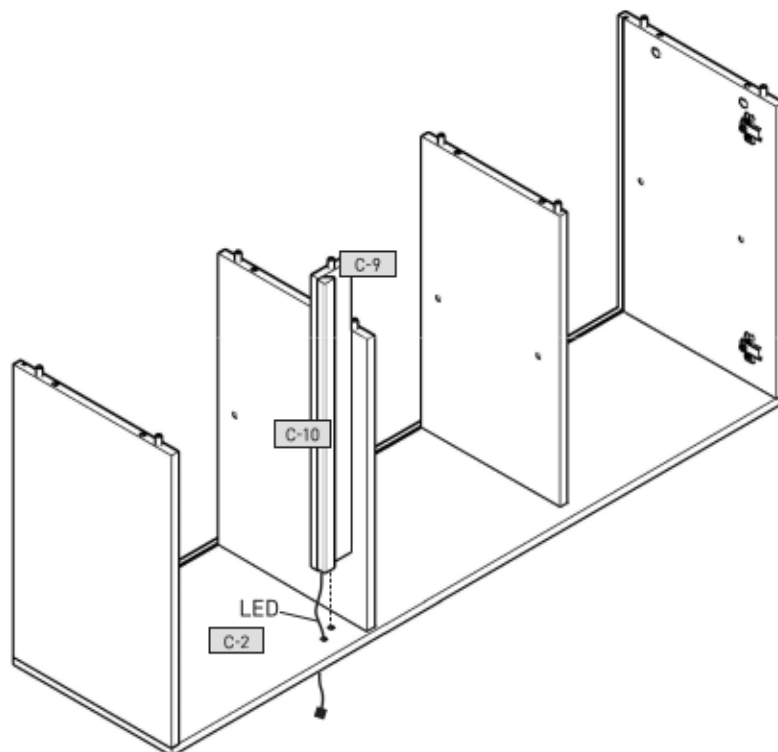
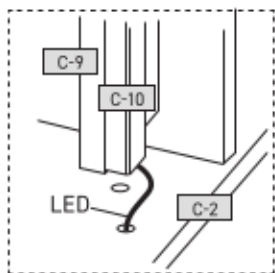

7

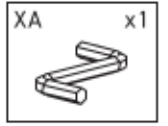
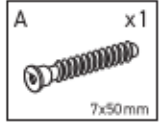
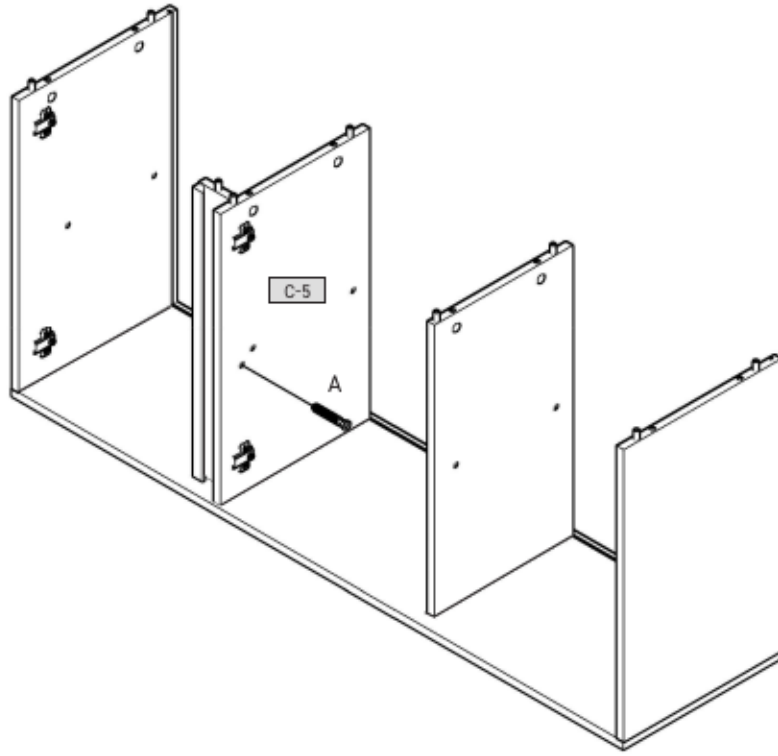

8

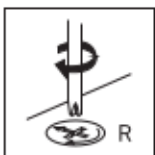
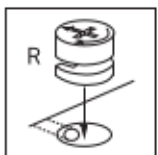
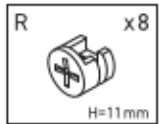
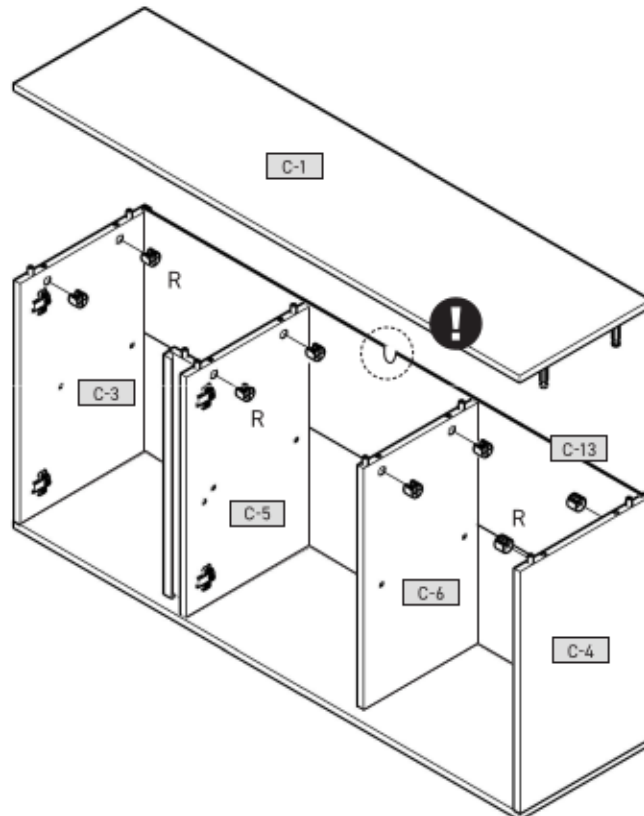

9

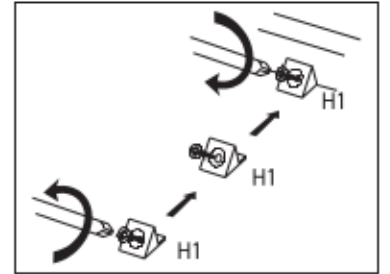
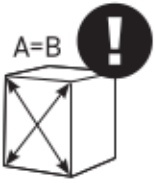
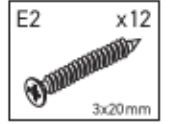
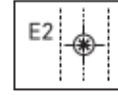
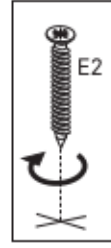
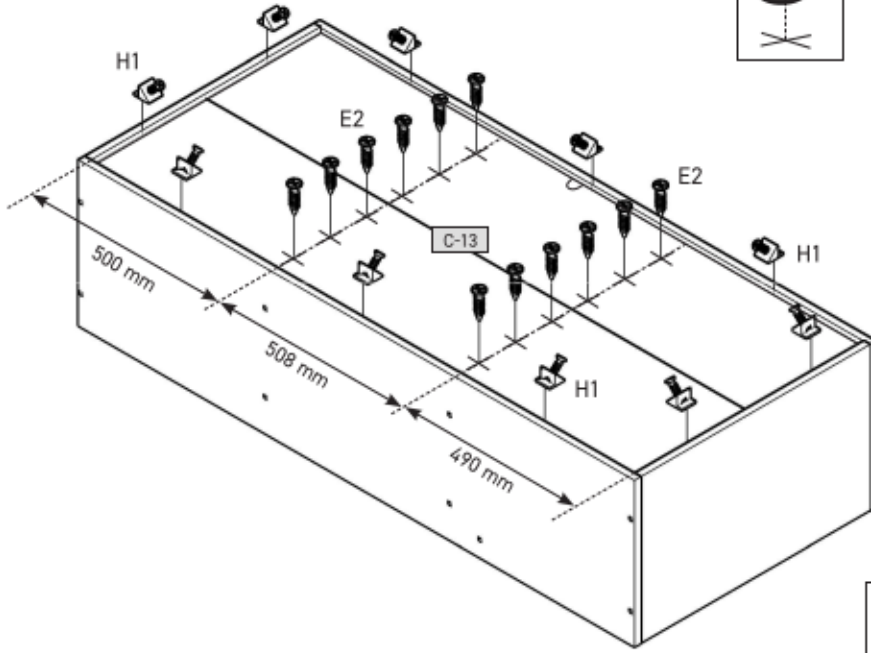

10

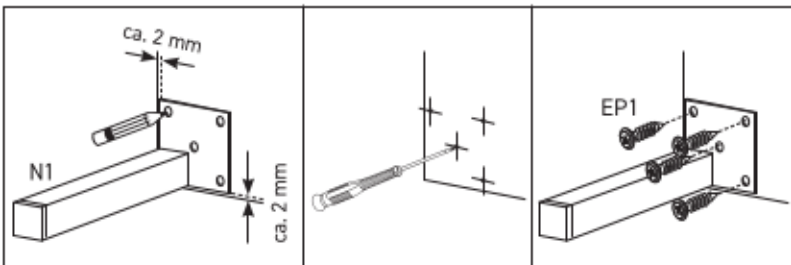
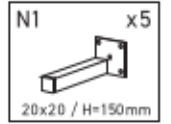
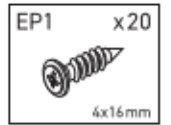
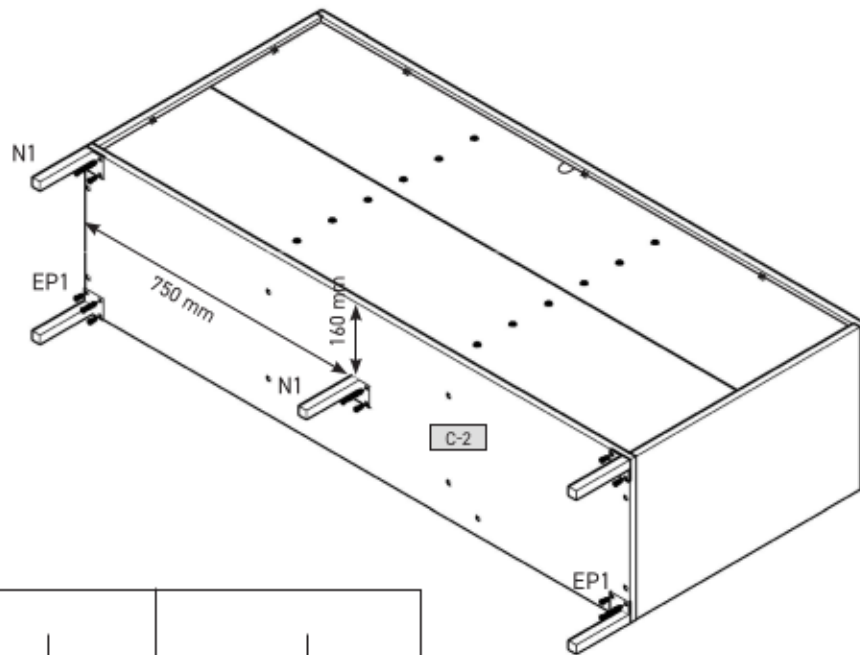

11

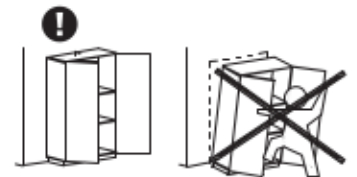
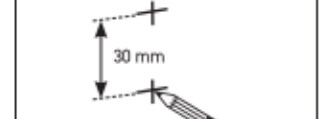
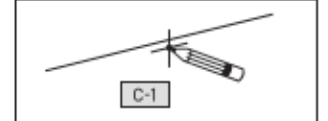
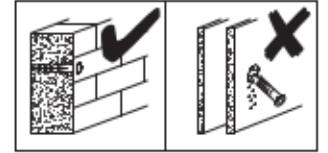
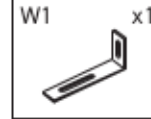
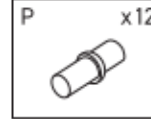
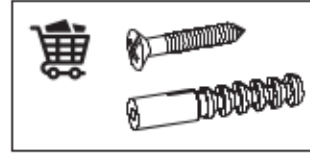
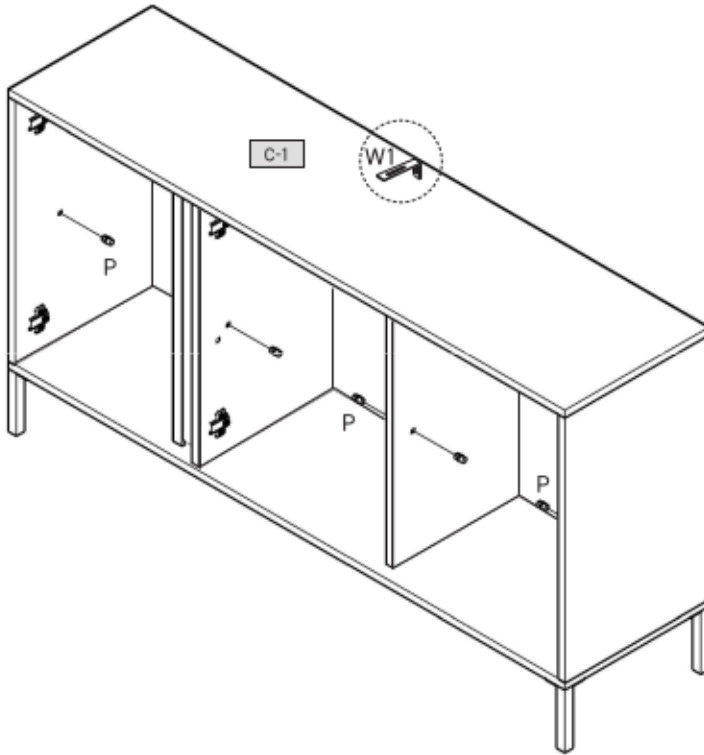
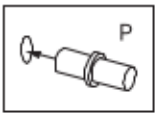

12

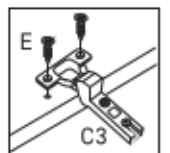
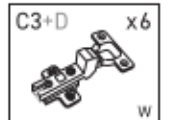
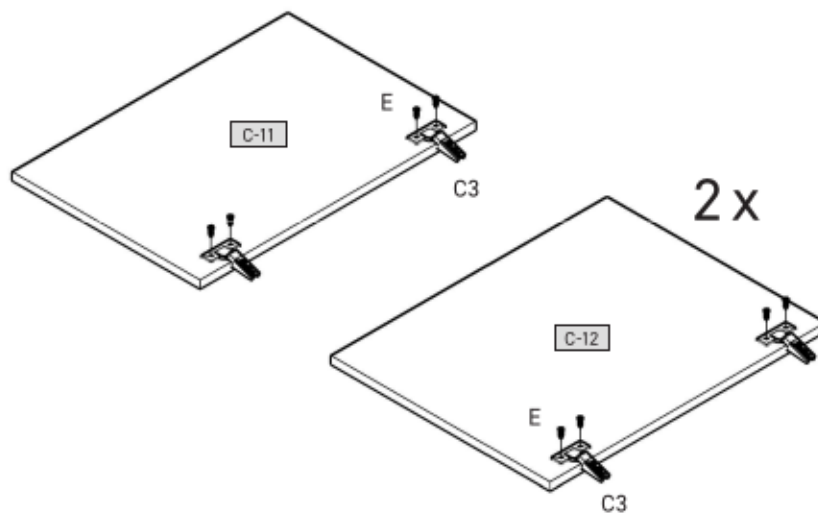

13

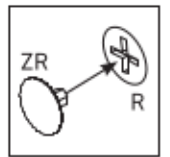
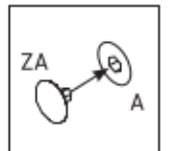
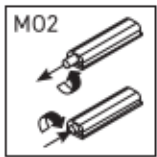
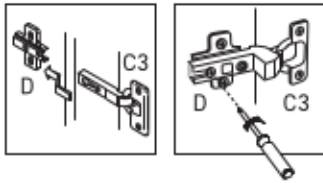
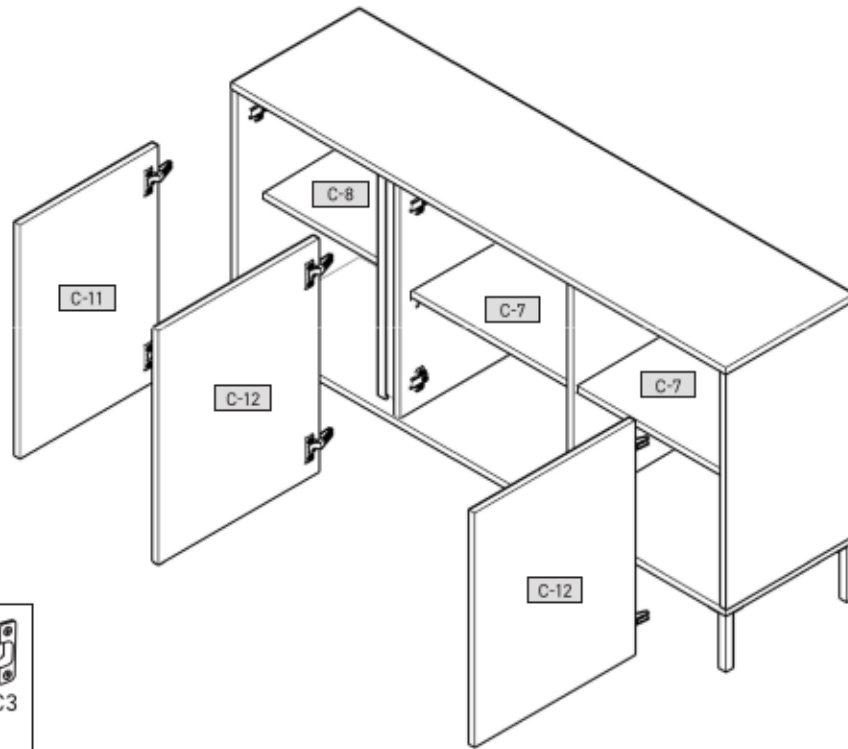
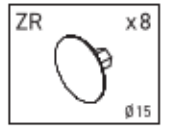
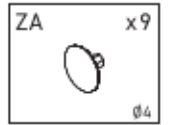

14

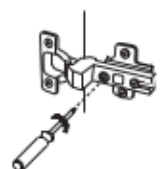
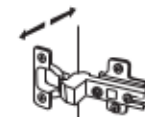
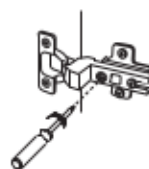
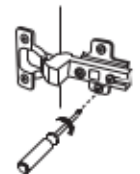
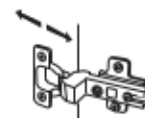
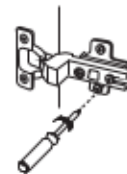
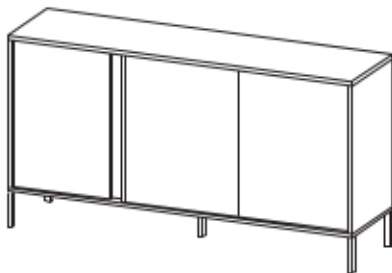
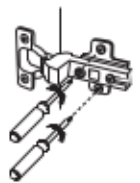
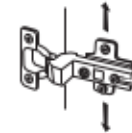
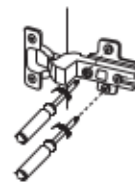

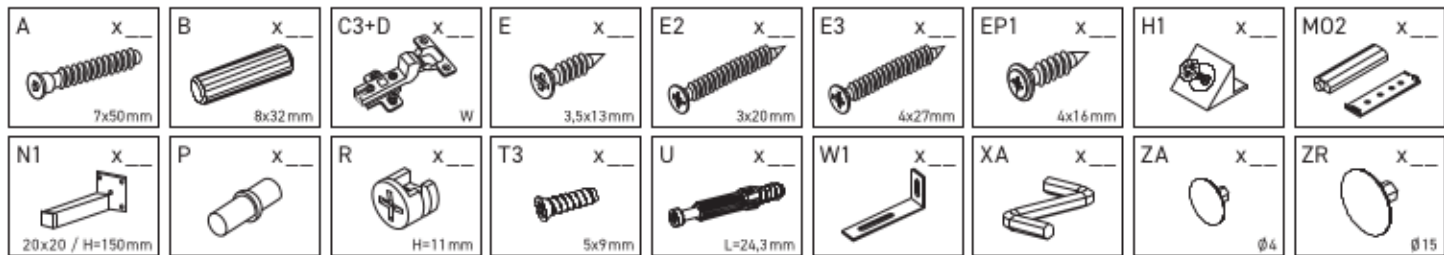

C-1	1531	395	16	x 1	1/2
C-2	1531	395	16	x 1	1/2
C-3	632	394	16	x 1	1/2
C-4	632	394	16	x 1	1/2
C-5	632	372	16	x 1	1/2
C-6	632	345	16	x 1	1/2
C-7	492	335	16	x 2	1/2
C-8	482	300	16	x 1	1/2
C-9	632	90	16	x 1	1/2
C-10	628	24	16	x 1	1/2
C-11	426	626	16	x 1	2/2
C-12	496	626	16	x 2	2/2
C-13	1512	646	3	x 1	1/2

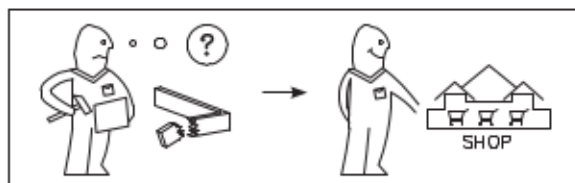
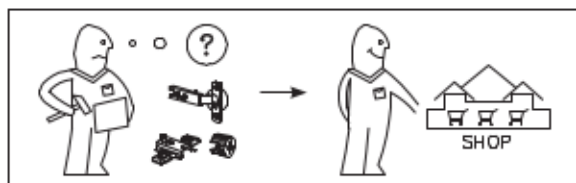
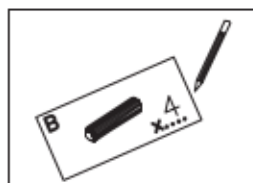
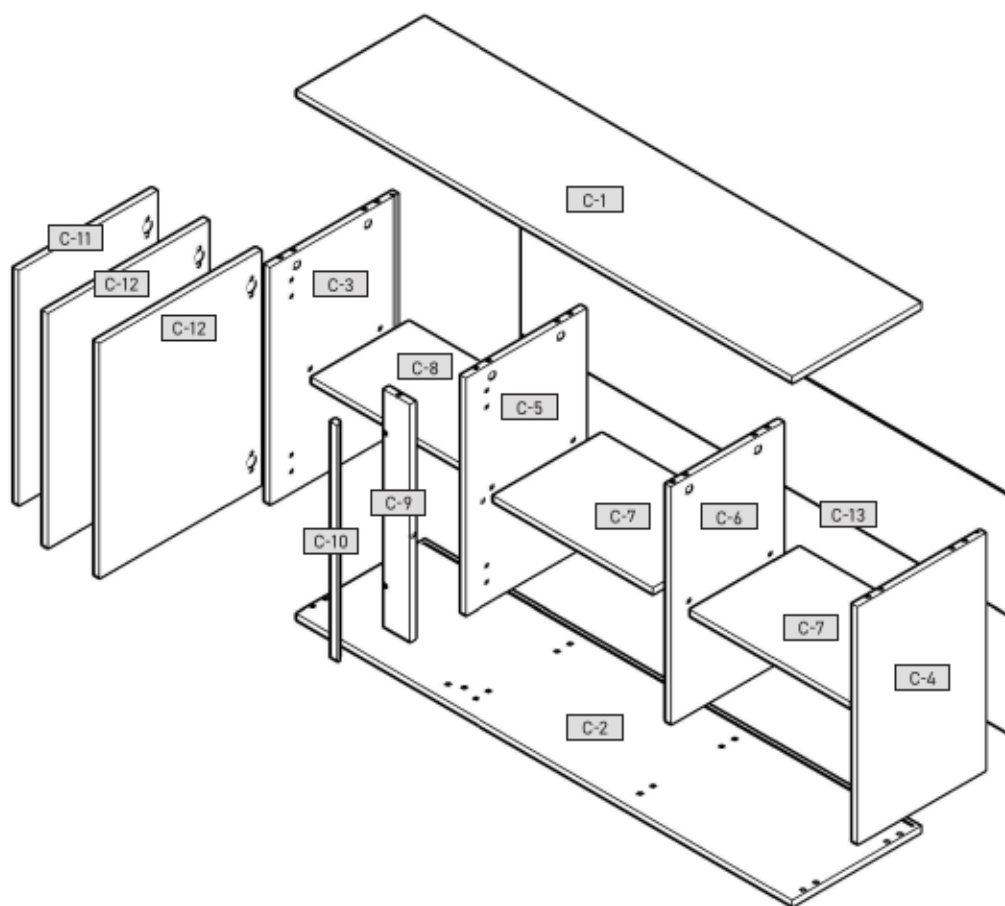

- DE** Möbel aus Naturholz und Pflanzenwerkstoffen
- PL** Mebel z drewna naturalnego oraz płk drewnopochodnych
- NL** Meubelen van natuurhout en plantmateriaal
- GB** Furniture made of natural wood and plant materials
- IT** Mobili in legno naturale e materiali pannellati
- FR** Meuble en bois naturel et plaques en dérivé du bois

DE

Liebe Kunden,
Ihrer Kunde, Ihre Bestellung!
 Vielen Dank für Ihre Bestellung!
 Ich bin sehr glücklich, dass Sie sich für ein Möbel entschieden haben. Ich habe Ihre Bestellung sofort in die Produktion gegeben. Ich werde mich bemühen, Ihnen ein hochwertiges Produkt zu liefern, das Ihre Erwartungen erfüllt. Ich werde Sie über den Fortschritt Ihrer Bestellung informieren. Wenn Sie Fragen haben, kontaktieren Sie mich bitte. Ich werde Ihnen gerne weiterhelfen. Ich hoffe, Sie werden mit Ihrem neuen Möbel zufrieden sein. Ich werde mich bemühen, Ihre Erwartungen zu erfüllen. Ich werde Sie über den Fortschritt Ihrer Bestellung informieren. Wenn Sie Fragen haben, kontaktieren Sie mich bitte. Ich werde Ihnen gerne weiterhelfen. Ich hoffe, Sie werden mit Ihrem neuen Möbel zufrieden sein. Ich werde mich bemühen, Ihre Erwartungen zu erfüllen.

Das Möbel aus Naturholz ist ein Produkt, das aus natürlichen Materialien hergestellt ist. Es ist ein Produkt, das die Schönheit und den Charakter des Naturholzes bewahrt. Es ist ein Produkt, das die Umwelt schonert und die Gesundheit fördert. Es ist ein Produkt, das die Qualität und die Haltbarkeit garantiert. Es ist ein Produkt, das die Schönheit und den Charakter des Naturholzes bewahrt. Es ist ein Produkt, das die Umwelt schonert und die Gesundheit fördert. Es ist ein Produkt, das die Qualität und die Haltbarkeit garantiert.

Grundausstattung gilt:
 • Keine heißen Gegenstände auf die Möbel setzen.
 • Keine Kerzen direkt auf die Möbel stellen.
 • Verschrützte Flüssigkeiten sofort aufwischen.
 • In regelmäßigen Abständen den Lack mit einem weichen Tuch abwischen.
 • Bei Verschmutzung sofort abwischen.
 • Bei Verschmutzung sofort abwischen.
 • Bei Verschmutzung sofort abwischen.

Bitte beachten:
 • Dieses Möbel ist ein Produkt, das aus natürlichen Materialien hergestellt ist. Es ist ein Produkt, das die Schönheit und den Charakter des Naturholzes bewahrt. Es ist ein Produkt, das die Umwelt schonert und die Gesundheit fördert. Es ist ein Produkt, das die Qualität und die Haltbarkeit garantiert. Es ist ein Produkt, das die Schönheit und den Charakter des Naturholzes bewahrt. Es ist ein Produkt, das die Umwelt schonert und die Gesundheit fördert. Es ist ein Produkt, das die Qualität und die Haltbarkeit garantiert.

- TR** Doğal ahşap ve kereste malzemelerden üretilmiş mobilyalar
- SU** Мебель из натурального дерева и древесных панелей
- RO** Mobilă din lemn natural și materiale floricelemoase
- CZ** Nábytek z přírodního dřeva a dřevotřískových deskových materiálů
- SK** Nábytok z prírodného dreva a drevoztrúskových deskových materiálov
- HL** Бүтэр хэмээхээс хийгээгүйгэд эх бэлтгэлээд

NL

Beste klant,
 Hartelijk dank voor uw bestelling!
 Het maakt me ontzettend blij dat u voor ons meubel heeft gekozen. Ik heb uw bestelling meteen in de productie gegeven. Ik zal mijn best doen om u een prachtig meubel te leveren dat aan uw verwachtingen voldoet. Ik zal u in kennis stellen van de voortgang van uw bestelling. Indien u vragen heeft, hoor ik u graag. Ik hoop dat u helemaal tevreden bent met uw nieuwe meubel. Ik zal mijn best doen om uw verwachtingen te overtreffen.

In principe geldt:
 • Niet hete voorwerpen op de meubels plaatsen.
 • Directe zonlicht op de meubels vermijden.
 • Vloeistoffen niet op de meubels laten.
 • In het geval van vloeistofvlekken deze onmiddellijk schoonmaken met een zachte doek.
 • Het meubel regelmatig met een zachte doek afvegen.
 • Het meubel niet met een harde doek schoonmaken.

Waxkawaii deyycaas pelegnaggi mebli z serowoglojeboweanoji drewna naturalnego
 Waxkawaii deyycaas pelegnaggi mebli z serowoglojeboweanoji drewna naturalnego. Waxkawaii deyycaas pelegnaggi mebli z serowoglojeboweanoji drewna naturalnego. Waxkawaii deyycaas pelegnaggi mebli z serowoglojeboweanoji drewna naturalnego.

Dział Rozwoju Produktu.
 Dział Rozwoju Produktu. Dział Rozwoju Produktu. Dział Rozwoju Produktu. Dział Rozwoju Produktu. Dział Rozwoju Produktu. Dział Rozwoju Produktu. Dział Rozwoju Produktu.

- GB** Dear customer, Thank you for your order! No matter if you bought a piece of furniture made from natural wood, a high-gloss front or a plastic front – every piece of furniture has unique characteristics. Even the texture and structure of wood, such as small knots in natural wood furniture, are part of the individual charms of each piece of furniture. Since natural wood furniture are permanently exposed to climate and humidity fluctuations, changes to the surface may occur (e.g. hair cracks or changes in colour) in some cases. In general, brightness decreases and colour saturation increases in the course of time – the wood darkens. The changes mentioned above are normal for natural raw materials such as wood. This booklet provides some care tips for your piece of furniture so that you can enjoy it for a long time.
- IT** Gentili clienti, sentiti ringraziamenti per il vostro ordine! No matter if you bought a piece of furniture made from natural wood, a high-gloss front or a plastic front – every piece of furniture has unique characteristics. Even the texture and structure of wood, such as small knots in natural wood furniture, are part of the individual charms of each piece of furniture. Since natural wood furniture are permanently exposed to climate and humidity fluctuations, changes to the surface may occur (e.g. hair cracks or changes in colour) in some cases. In general, brightness decreases and colour saturation increases in the course of time – the wood darkens. The changes mentioned above are normal for natural raw materials such as wood. This booklet provides some care tips for your piece of furniture so that you can enjoy it for a long time.

TI

Sostanzialmente vale:
 • Non poggiare oggetti roventi sui mobili.
 • Non poggiare candele a diretto contatto dei mobili.
 • Asciugare subito i liquidi versati.
 • Ad intervalli periodici controllare se viti e cerniere sono salde.
 • Il caratteristico odore fragrante è sempre affnché vi procuri lunghe soddisfazioni.

Il presente libretto intende darvi alcuni suggerimenti sulla cura del vostro mobile, affinché vi procuri lunghe soddisfazioni.
 Sostanzialmente vale:
 • Non poggiare oggetti roventi sui mobili.
 • Non poggiare candele a diretto contatto dei mobili.
 • Asciugare subito i liquidi versati.
 • Ad intervalli periodici controllare se viti e cerniere sono salde.
 • Il caratteristico odore fragrante è sempre affnché vi procuri lunghe soddisfazioni.

Il presente libretto intende darvi alcuni suggerimenti sulla cura del vostro mobile, affinché vi procuri lunghe soddisfazioni.
 Sostanzialmente vale:
 • Non poggiare oggetti roventi sui mobili.
 • Non poggiare candele a diretto contatto dei mobili.
 • Asciugare subito i liquidi versati.
 • Ad intervalli periodici controllare se viti e cerniere sono salde.
 • Il caratteristico odore fragrante è sempre affnché vi procuri lunghe soddisfazioni.

Il presente libretto intende darvi alcuni suggerimenti sulla cura del vostro mobile, affinché vi procuri lunghe soddisfazioni.
 Sostanzialmente vale:
 • Non poggiare oggetti roventi sui mobili.
 • Non poggiare candele a diretto contatto dei mobili.
 • Asciugare subito i liquidi versati.
 • Ad intervalli periodici controllare se viti e cerniere sono salde.
 • Il caratteristico odore fragrante è sempre affnché vi procuri lunghe soddisfazioni.

- FR** Cher client, merci pour votre commande ! Quel que soit le matériau de votre meuble (bois naturel, bois vernis, brillant, bois peint, etc.), chaque meuble a ses propres caractéristiques. Même la structure du bois, comme par exemple les petits nœuds sur des meubles en bois naturel, font partie de l'aspect de son charme. Puisqu'un meuble en bois naturel est exposé aux variations permanentes de température et d'humidité, il se peut que quelques modifications surviennent sur la surface, comme par exemple de fines fissures ou des décorations. En règle générale, au cours du temps, le claret du bois s'assombrit et la saturation des couleurs diminue – le bois s'assombrit. Les changements mentionnés ci-dessus sont normaux pour des matériaux naturels tels que le bois. Ce petit livret vous donne quelques conseils sur l'entretien de votre meuble pour que vous puissiez en profiter longtemps.

FR

En règle générale:
 • Évitez de poser d'objets chauds sur le meuble.
 • Ne pas poser de bougies directement sur le meuble.
 • Essayez immédiatement les liquides renversés.
 • A intervalles réguliers, contrôlez que les vis et les charnières sont bien en place.
 • Vérifiez périodiquement si les vis et les charnières sont bien en place.
 • Vérifiez périodiquement si les vis et les charnières sont bien en place.

En règle générale:
 • Évitez de poser d'objets chauds sur le meuble.
 • Ne pas poser de bougies directement sur le meuble.
 • Essayez immédiatement les liquides renversés.
 • A intervalles réguliers, contrôlez que les vis et les charnières sont bien en place.
 • Vérifiez périodiquement si les vis et les charnières sont bien en place.
 • Vérifiez périodiquement si les vis et les charnières sont bien en place.

En règle générale:
 • Évitez de poser d'objets chauds sur le meuble.
 • Ne pas poser de bougies directement sur le meuble.
 • Essayez immédiatement les liquides renversés.
 • A intervalles réguliers, contrôlez que les vis et les charnières sont bien en place.
 • Vérifiez périodiquement si les vis et les charnières sont bien en place.
 • Vérifiez périodiquement si les vis et les charnières sont bien en place.

En règle générale:
 • Évitez de poser d'objets chauds sur le meuble.
 • Ne pas poser de bougies directement sur le meuble.
 • Essayez immédiatement les liquides renversés.
 • A intervalles réguliers, contrôlez que les vis et les charnières sont bien en place.
 • Vérifiez périodiquement si les vis et les charnières sont bien en place.
 • Vérifiez périodiquement si les vis et les charnières sont bien en place.

Your product development team

Area Sviluppo prodotti

Ihre Produktentwicklung

De productontwikkelingsafdeling

Dział Rozwoju Produktu.

