

MONTAGEANLEITUNG
 INSTRUKCJA MONTAŻU
 FITTING-UP INSTRUCTION
 ІНСТРУКЦІЯ МОНТАЖУ
 ИНСТРУКЦИЯ СБОРКИ

MONTÁŽNY NÁVOD
 INSTRUCTIONS POUR LE MONTAGE
 INSTRUCCIONES DE MONTAJE
 SZERELÉSI ÚTMUTATÓ
 UPUTE ZA SASTAVLJANJE

Notwendiges Montagewerkzeug:
 Do montażu potrzebne są:
 You need for fitting-up:
 Для монтажу потрібно:
 Для сборки нужны:

Pour le montage il faut:
 Para realizar el montaje es necesario:
 K montá i potrebujete:
 A szereléshez szükséges:
 Za sastavljanje su potrebne:

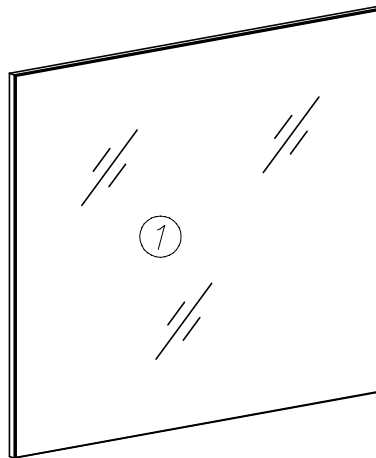
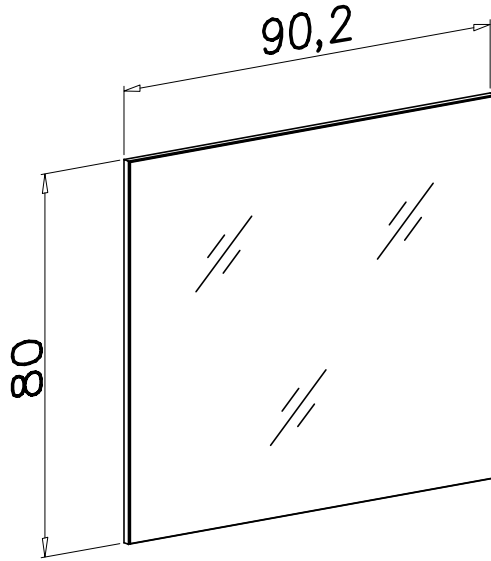
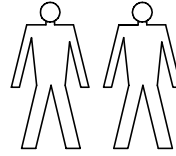
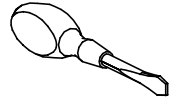
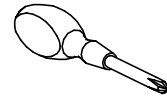
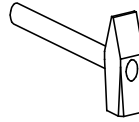
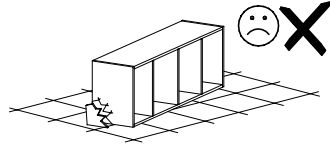
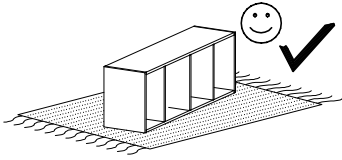

W4



2x

G46



4x

U7S



2x

U8

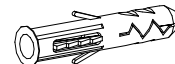

2x

7x3

5x9

∅10x50

1

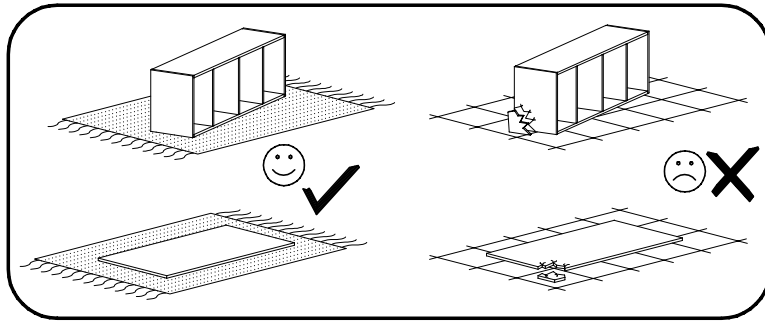

G46 

5x9 4x

W4 

7x3 2x

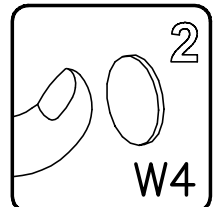
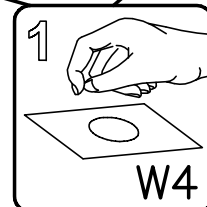
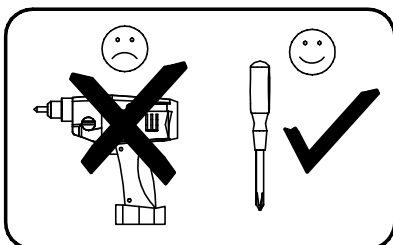
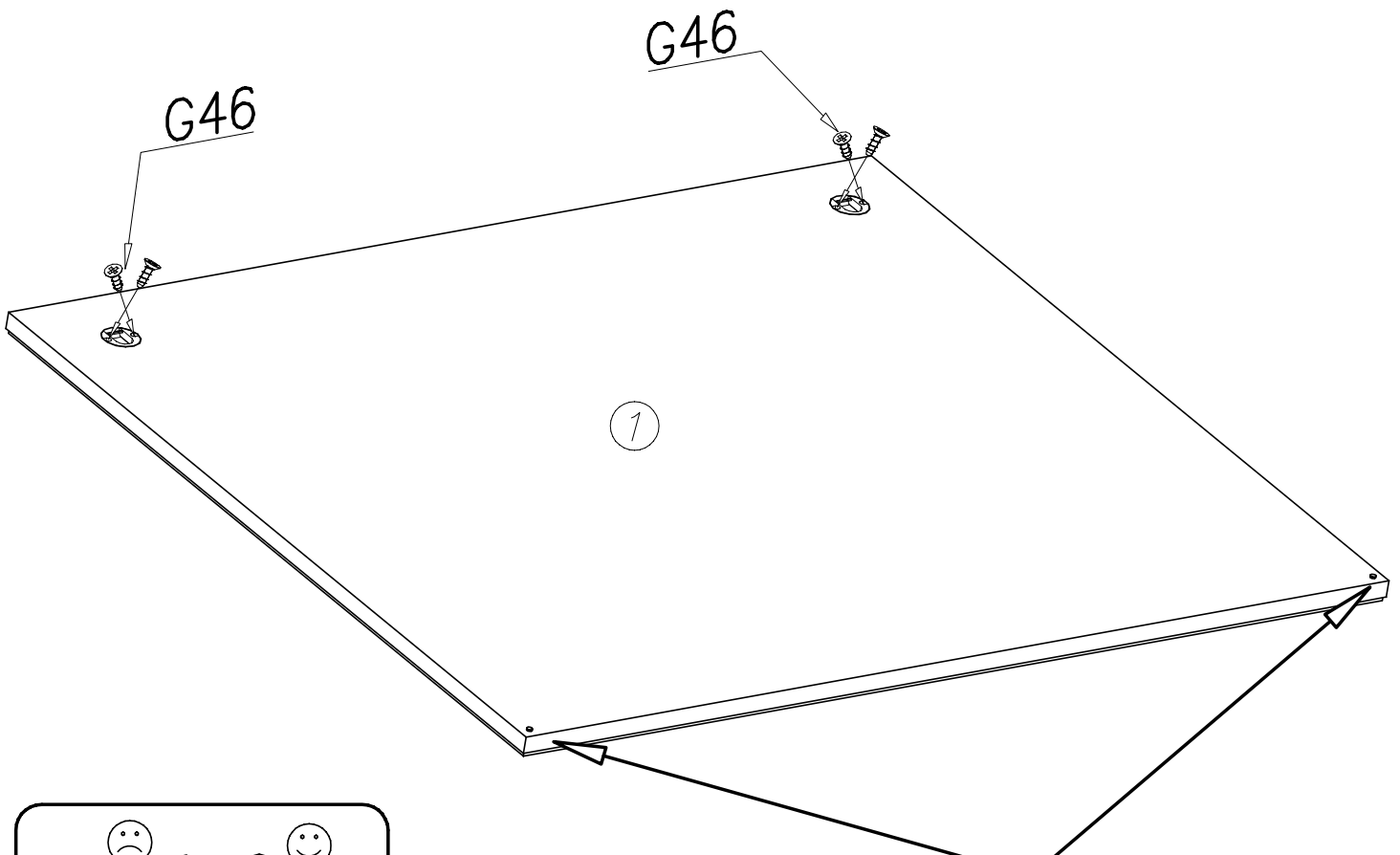
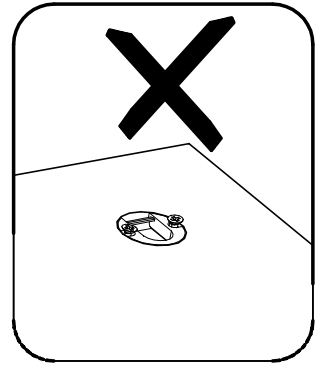
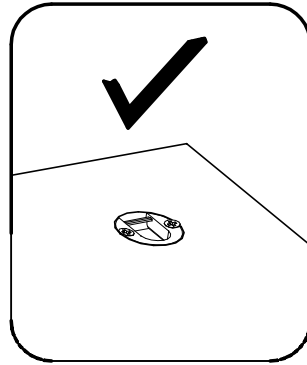
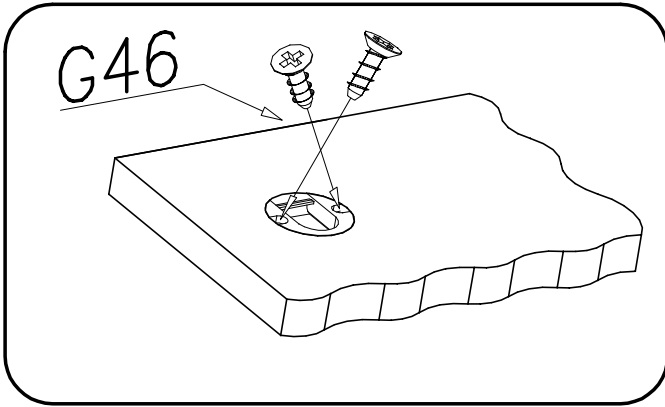

2

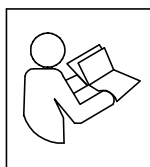

U8
Ø10x50 2x

U7S
2x

1

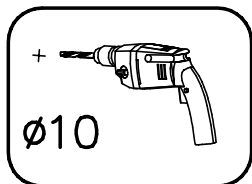

2

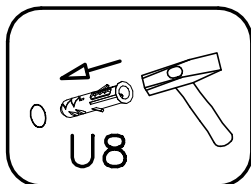

3

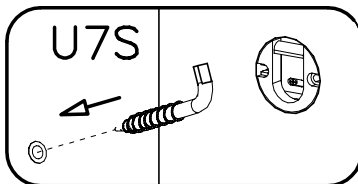

4

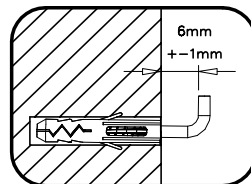

5

