

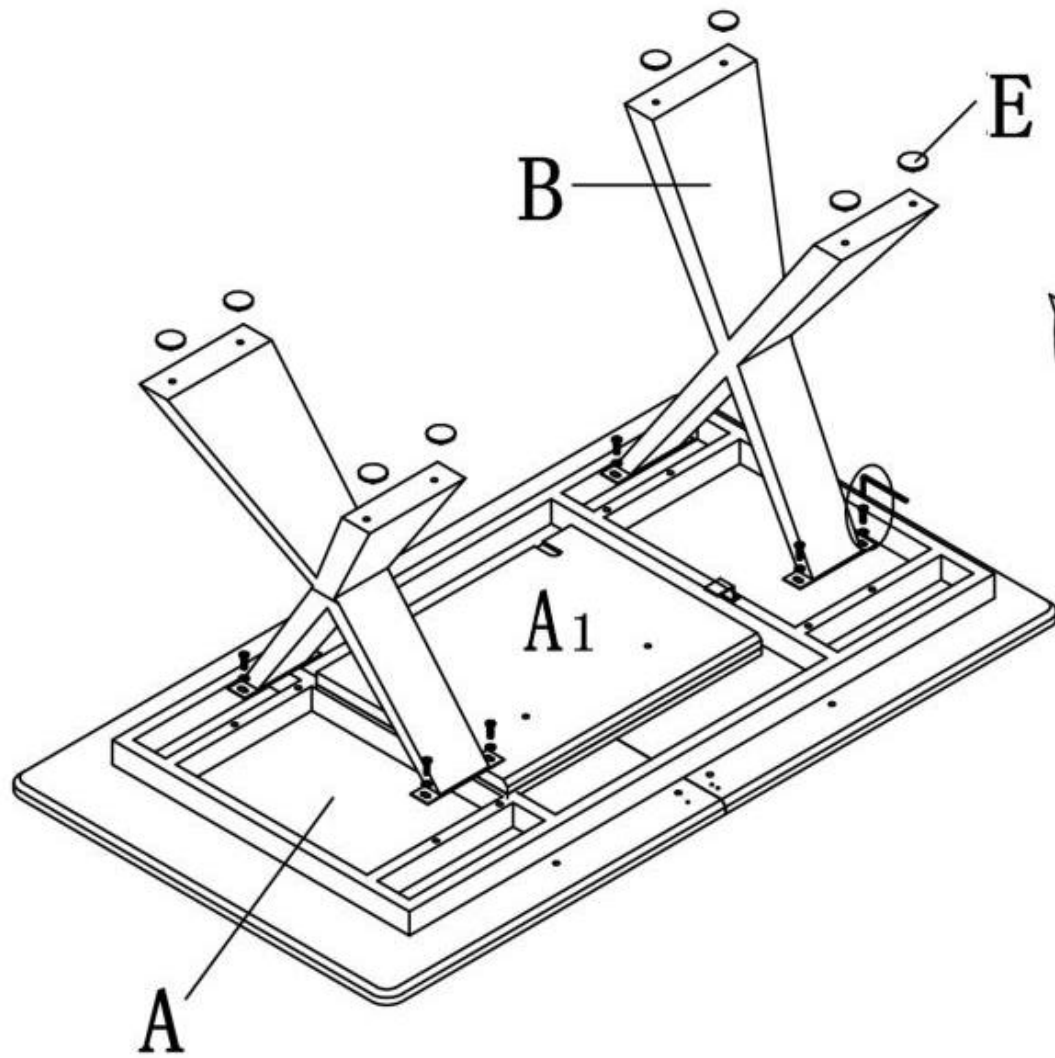

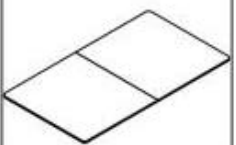

# CHANDLER

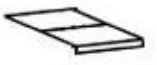
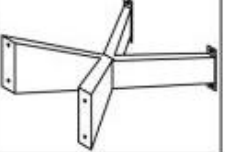

A		1
A1		1
B		2
C		8
D		8
E		8

 max. 60 kg

