

2SBL

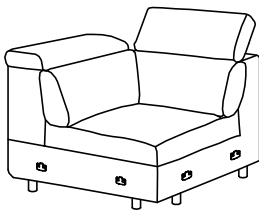

R

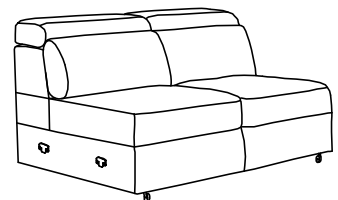

3F

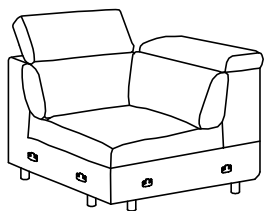

R

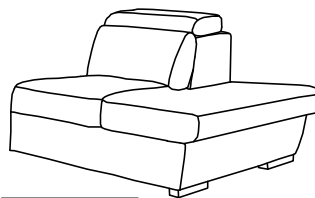

OSP

M6.0x60mm			
	A	B	C
	18	4	10

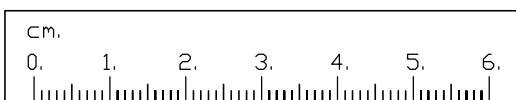

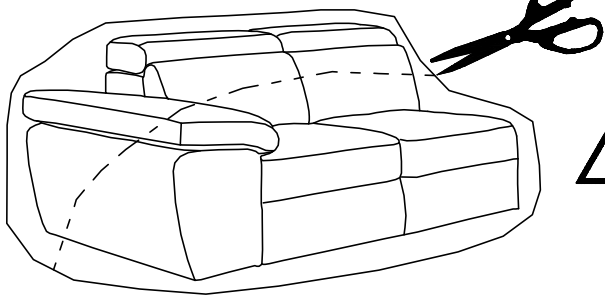

1

2SBL



2

M6.0x60mm	
 A	 B
4	2

2SBL

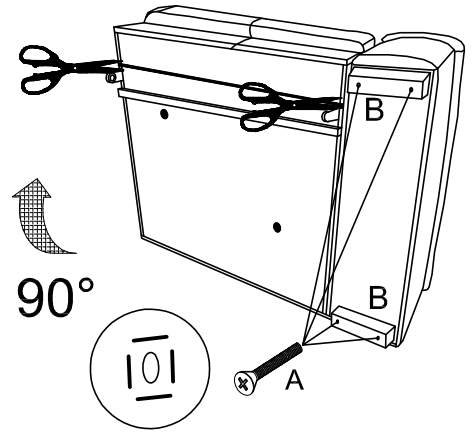



3

R

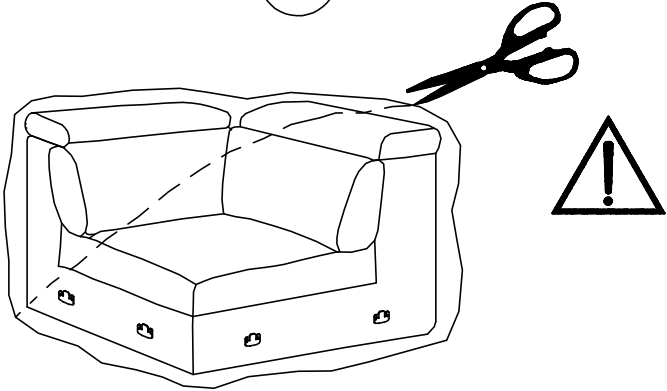
2x



4

M6.0x60mm	
 A	 C
10	10

R

2x

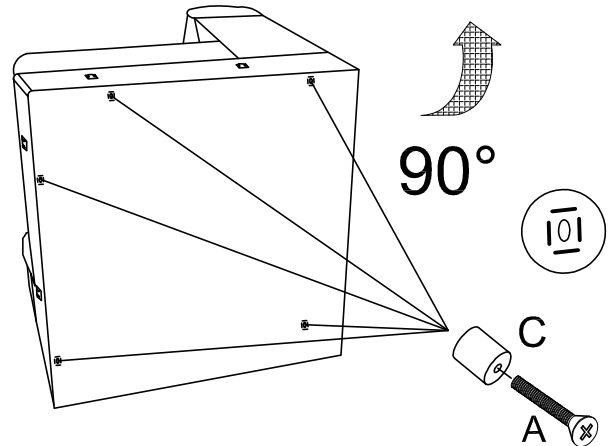

5

3F

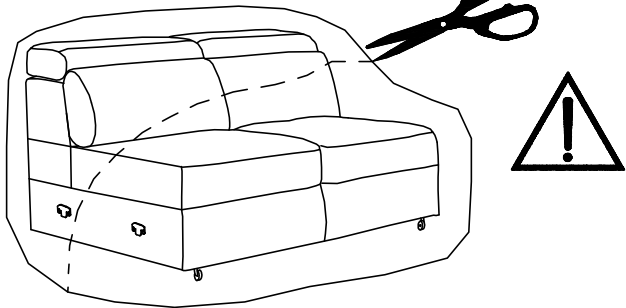

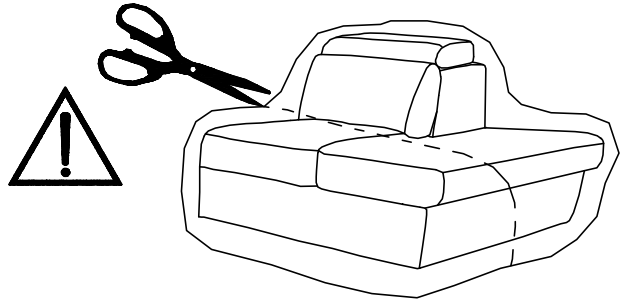
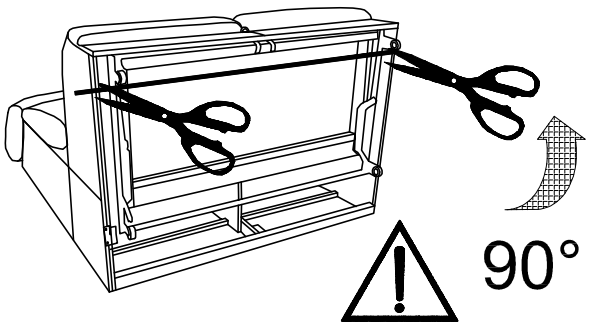

6

OSP



7

M6.0x60mm	
 A	 B
4	2

OSP

90°

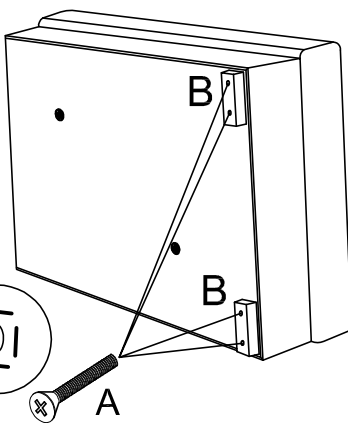

OSL

90°

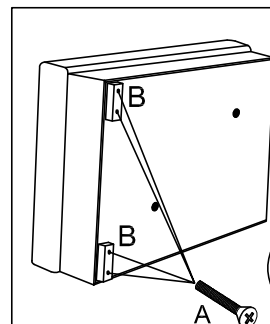

8

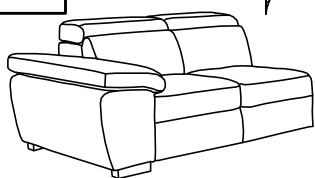

2SBL

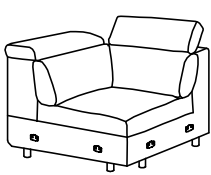

R

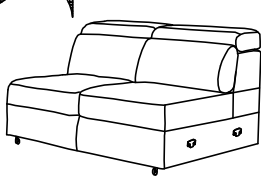

3F

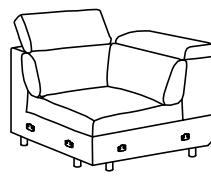

R

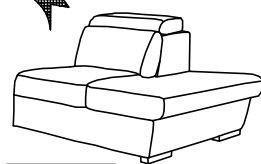

OSP

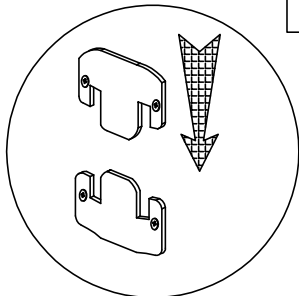
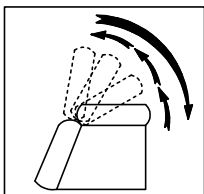

R

3F

R

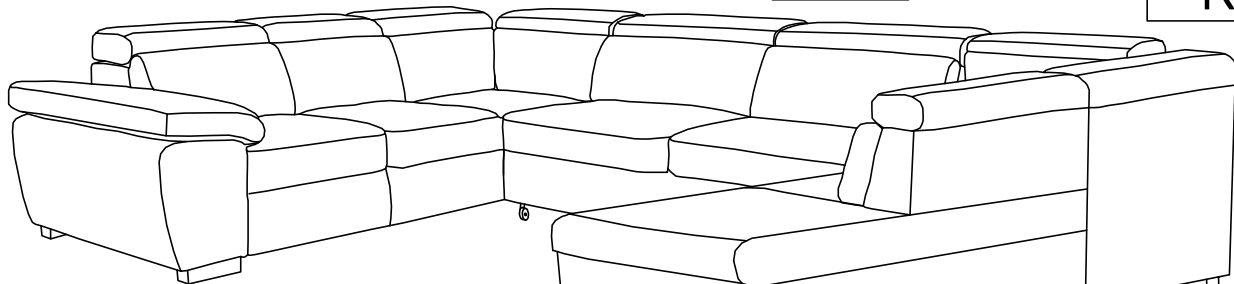

2SBL

OSP

9

3F

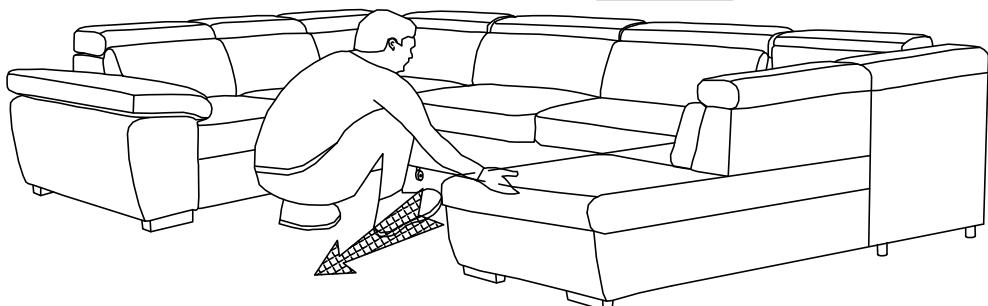

10

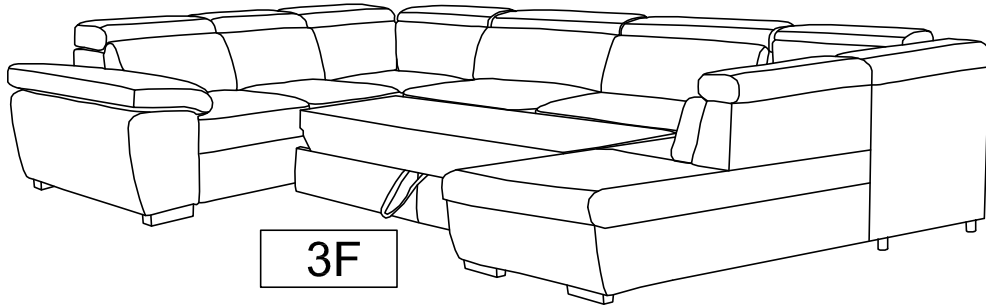
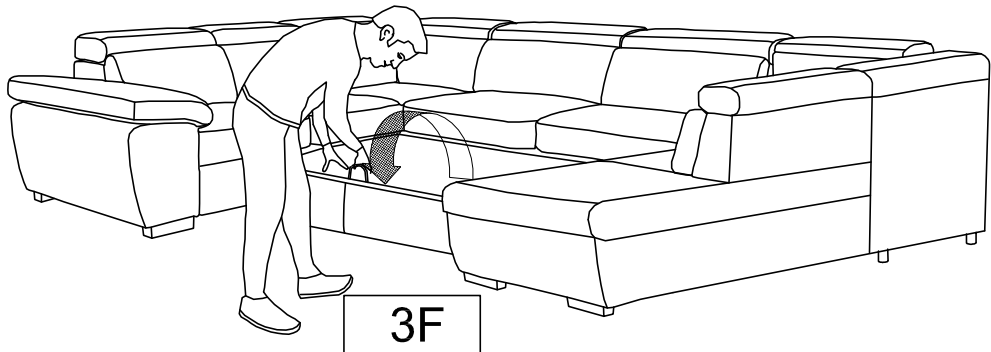

11

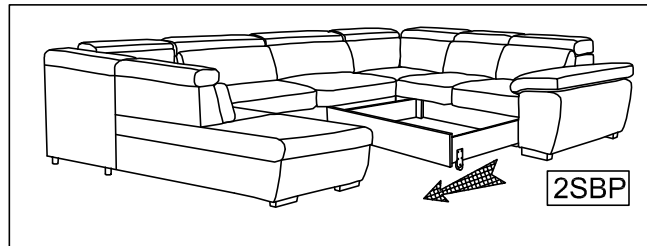
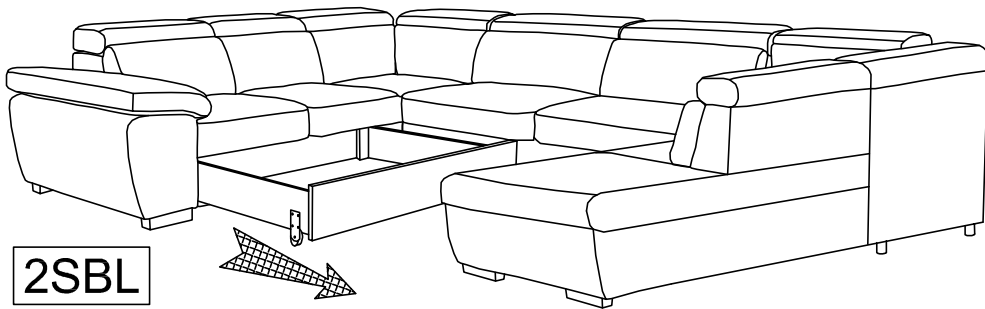

12

