

VERSION - L

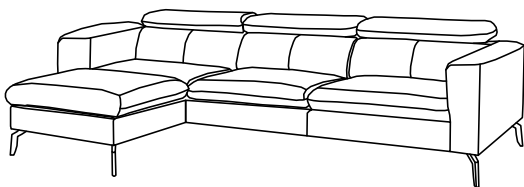

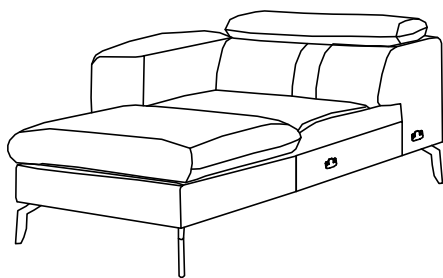

VERSION - R

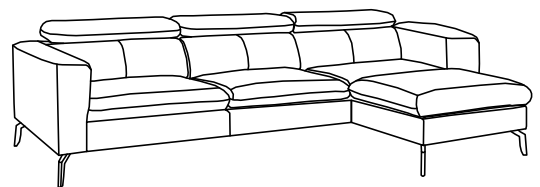

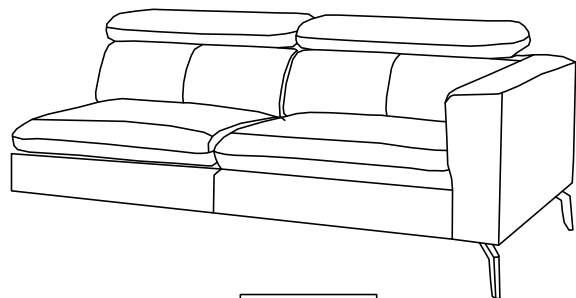
OBL



2 BP

| | | |
|--|-----------|---|
|  | M6.0x40mm |  |
| A | B | C |
| 6 | 24 | 2 |



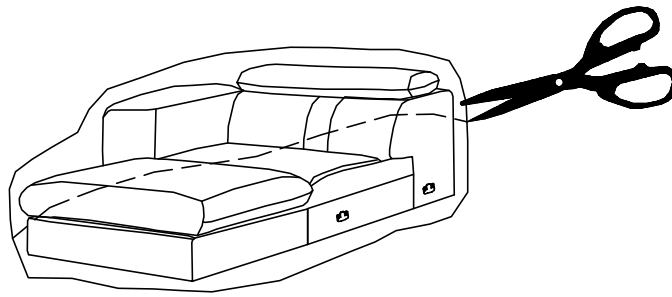

1

OBL



2

| | | | |
|---|-----------|---|---|
|  | M6.0x40mm |  |  |
| A | | B | C |
| 4 | | 16 | 1 |

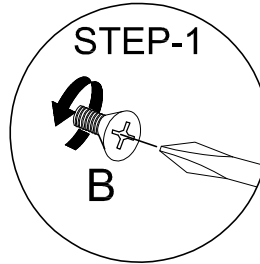
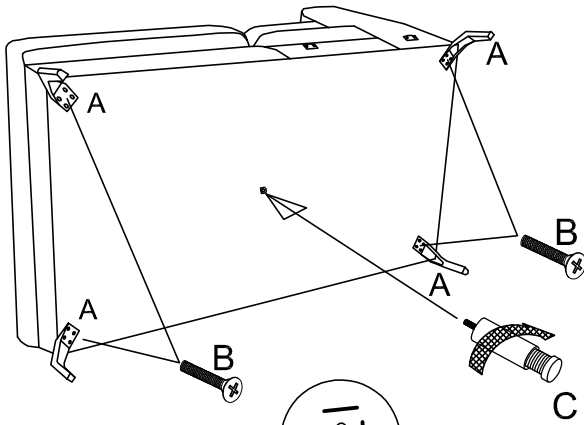
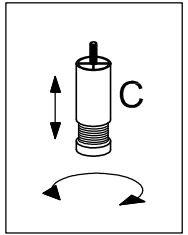
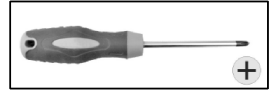

OBL

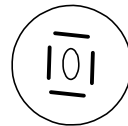
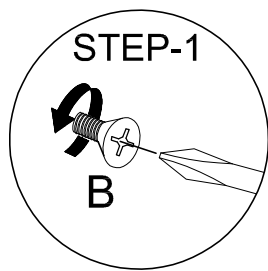
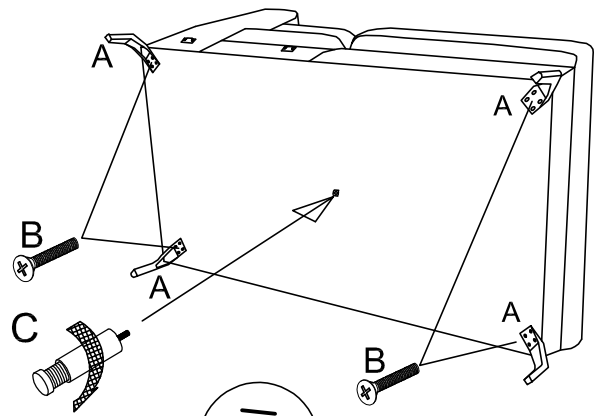
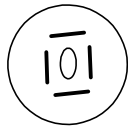

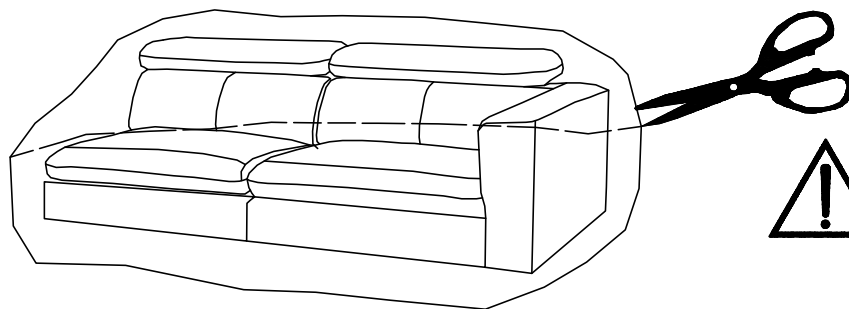

OBP

3



2 BP

4

| | | | |
|--|-----------|--|--|
|  | M6.0x40mm |  |  |
| A | | B | C |
| 2 | | 8 | 1 |

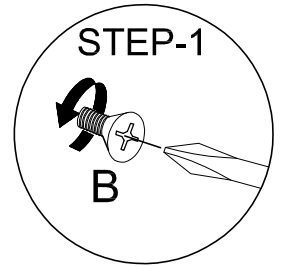
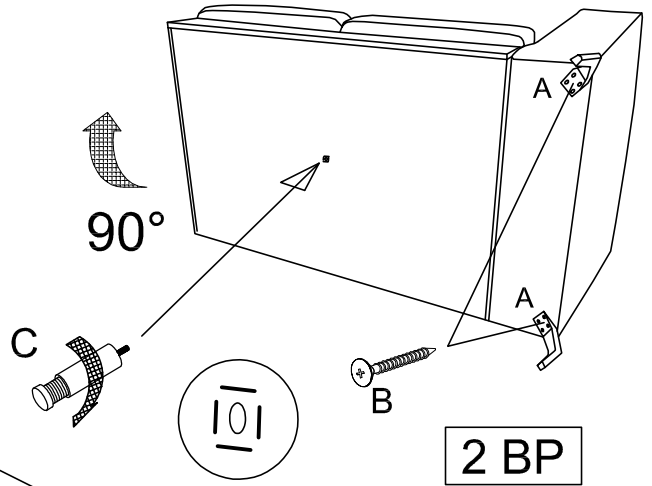
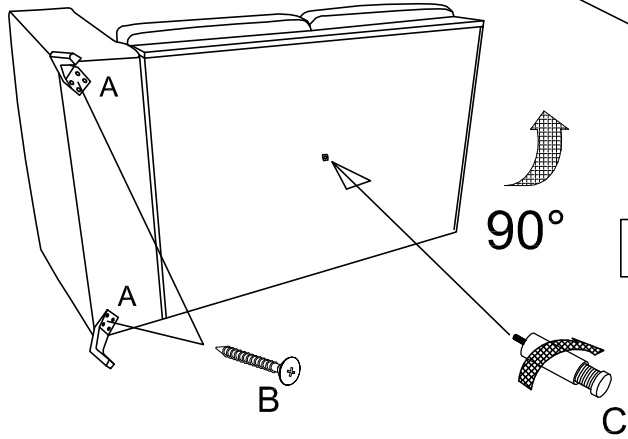
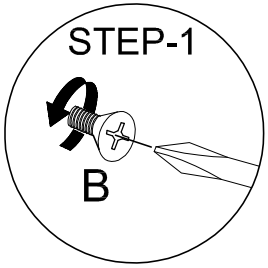
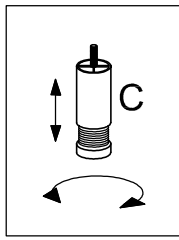

5

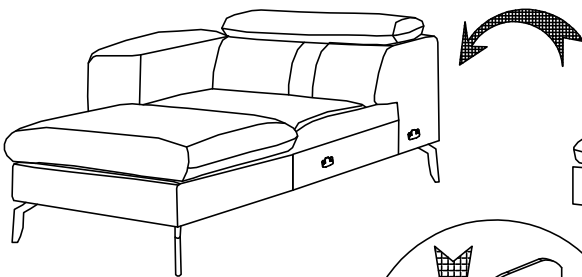

OBL

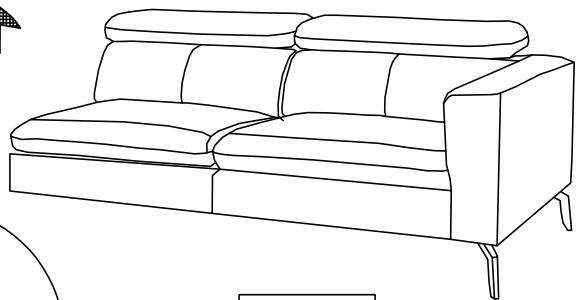

2 BP

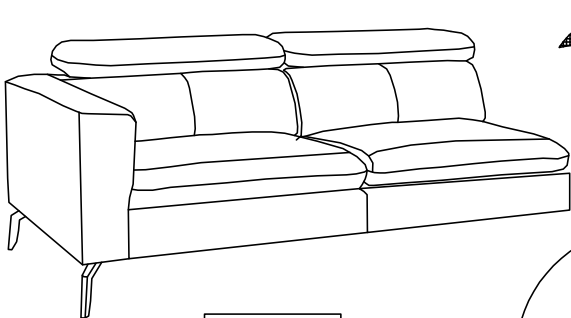
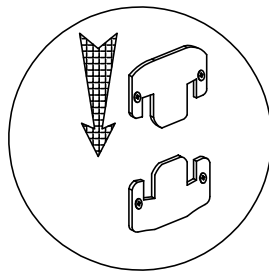

2 BL

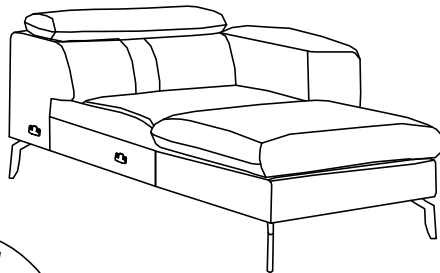

OBL

